

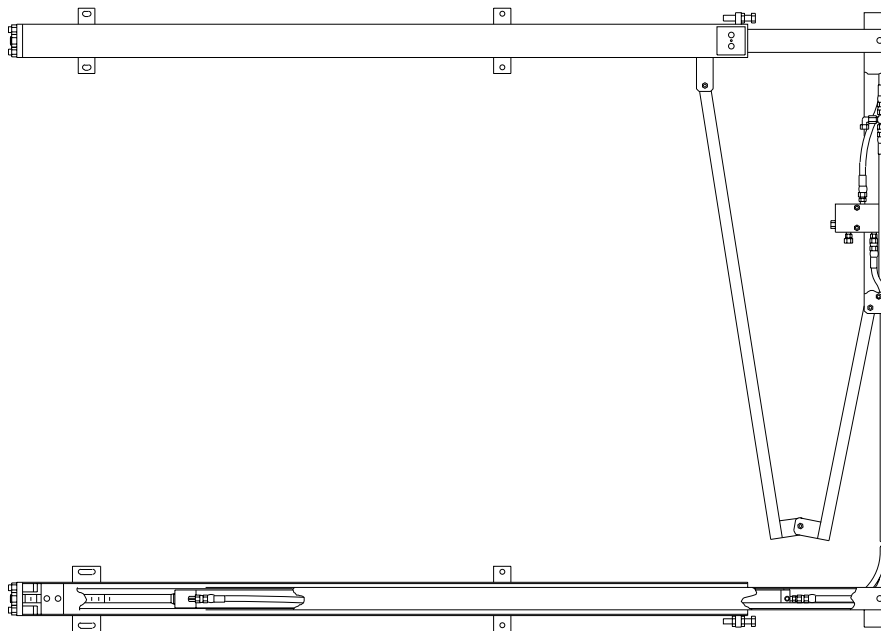

# REPAIR MANUAL

## HWH SPACEMAKER ROOM EXTENSION SYSTEM 200 SERIES HYDRAULIC LEVELING SYSTEM FOR WINNEBAGO MOTORIZED VEHICLES

**FEATURING:  
DUAL CYLINDER "RAIL" ROOM EXTENSION  
(WITH RACK SENSING VALVE)**



**HWH CORPORATION  
(ON I-80, EXIT 267 SOUTH)  
2096 MOSCOW ROAD  
MOSCOW, IOWA 52760  
(800) 321-3494 / (563) 724-3396  
INTERNET: <http://www.hwhcorp.com>**

**ML11570/MI91.0006  
07MAR01**

# SECTION 1

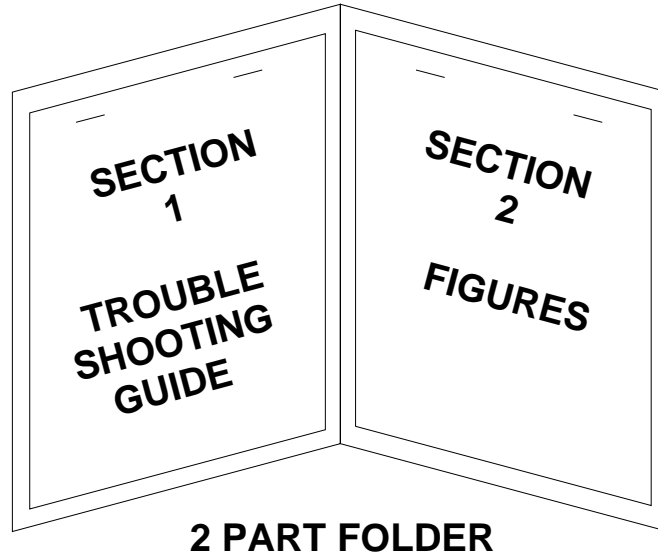

## HOW TO USE MANUAL

**NOTE:** This manual will work for systems with single cylinder room extensions also. The only difference is the exclusion of rack sensing valve problems or adjustments.

This manual is written in two sections. Section 1 is the Trouble Shooting Guide. Section 2 is the figures. Begin diagnosis of the system with Section 1, the Trouble Shooting Guide. The Trouble Shooting Guide is broken into 3 columns, Problem, Solutions and Figures. Under Problems, find the symptom you have encountered. The testing and repair for that problem is in the Solution (center) column. Diagrams for a particular Problem and Solution are in the Figures (right hand) column. This column will direct you to the proper figure in Section 2, Figures, for a more detailed view.

Before beginning your repair, it is IMPORTANT to read the CAUTIONS and NOTES AND CHECKS in the first section, TROUBLE SHOOTING GUIDE. In many cases this will save time and mistakes when trouble shooting a system.

This Repair Manual is offered as a guide only. It is impossible to anticipate every problem or combination of problems. For any problems encountered that are not addressed in this manual, contact HWH Corporation for assistance. (800-321-3494)

The room should be fully retracted before Trouble Shooting the system. If the room will not retract, use the manual retract procedure on pages MP35.9410 and MP35.9490.

**Make sure all room locks and the manual retract winch are not engaged before trouble shooting the system.**

**PROCEED WITH TROUBLE SHOOTING GUIDE**



# TROUBLE SHOOTING

## CAUTIONS!

**BLOCK FRAME AND TIRES SECURELY BEFORE CRAWLING UNDER VEHICLE. DO NOT USE THE LEVELING JACKS OR AIR SUSPENSION TO SUPPORT VEHICLE WHILE UNDER VEHICLE OR CHANGING TIRES. VEHICLE MAY DROP AND OR MOVE FORWARD OR BACKWARD WITHOUT WARNING CAUSING INJURY OR DEATH.**

**WHEN ROUTING OR REROUTING HYDRAULIC HOSES AND WIRES, BE SURE THEY ARE NOT EXPOSED TO ENGINE EXHAUST OR ANY HIGH TEMPERATURE COMPONENTS OF THE VEHICLE.**

**NEVER PLACE HAND OR OTHER PARTS OF THE BODY NEAR HYDRAULIC LEAKS. OIL MAY CUT AND PENETRATE THE SKIN CAUSING INJURY OR DEATH.**

**SAFETY GLASSES ARE TO BE WORN TO PROTECT EYES FROM DIRT, METAL CHIPS, OIL LEAKS, ETC. FOLLOW ALL OTHER SHOP SAFETY PRACTICES.**

## NOTES AND CHECKS

Read and check before proceeding with Trouble Shooting Steps.

**NOTE: HWH CORPORATION ASSUMES NO LIABILITY FOR DAMAGES OR INJURIES RESULTING FROM THE INSTALLATION OR REPAIR OF THIS PRODUCT.**

1. If the room extension cannot be retracted, see Figures pages MP35.9410 and MP35.9490 for temporary measures. Make sure the manual retract valves are closed before trouble shooting.

**IMPORTANT :** The room extension will not operate unless a jack is extended enough to turn a Jacks Down Warning light on, but the vehicle should NOT be supported by the leveling jacks when working on the room extension.

2. Check that the oil reservoir is full with the room in the fully retracted position.

3. Batteries should read 13 volts. Batteries must be in good condition with no weak cells. The system will draw up to 200 amps. An alternator, converter or battery charger will not supply enough power for the system to operate properly.

4. Proper ground of all components is critical. See the electrical circuit for specific grounds required. Faulty grounds, especially for the solenoid manifold or the pump assembly, may cause component damage and /or improper or erratic operation.

**This manual is intended for use by experienced mechanics with knowledge of hydraulic and automotive electrical systems. People with little or no experience with HWH Room Extension systems should contact HWH technical service (800-321-3494) before beginning. Special attention should be given to all cautions, wiring, and hydraulic diagrams.**

Suggested tools for trouble shooting the HWH room extension systems:

JUMPER WIRES(UP TO 10 GAUGE)  
PRESSURE GAUGE(3500 PSI MIN.)  
MULTI-METER  
12 VOLT TEST LIGHT

**PROCEED WITH THE TROUBLE SHOOTING STEPS ON THE FOLLOWING PAGE**



# TROUBLE SHOOTING

The following is a list of possible problems and solutions which might occur to the room extensions. Only qualified technicians should install or repair room extension systems. An understanding of the operation of the room extension hydraulic and electrical components is required. Contact HWH Corporation technical service for assistance at (800) - 321 - 3494.

The following conditions must be met for the room extension to operate. The ignition must be in the "ACC" position. The park brake must be set. The HWH leveling system panel must be on. A red "Jack Down Warning Light" on the HWH panel must be on. (A jack must be extended approximately two inches)

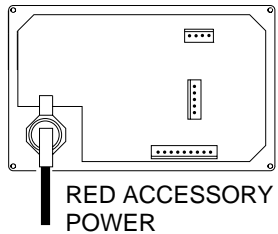
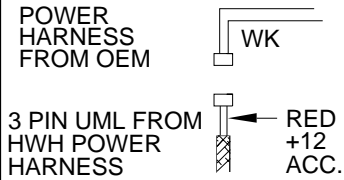
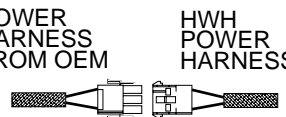
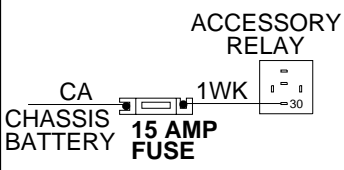
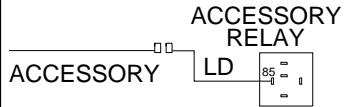
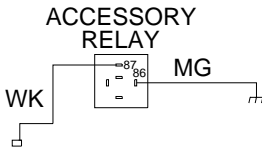
PROBLEM	SOLUTION	FIGURES
<p><b>Part 1</b>  <b>The HWH leveling system light panel will not turn on.</b></p>	<p>Check for power on the red wire connected to the fuse holder on the back of the light panel. If power is present, check the fuse and the park brake circuit. Then replace the panel if necessary.</p>	 <p style="text-align: center;">RED ACCESSORY POWER</p> <p style="text-align: center;"><b>REFER TO MP85.9417</b></p>
<p><b>Power is not present on the red wire at the back of the light panel.</b></p>	<p>Check for +12 power on the red wire (HWH) and the wire marked "WK" (WINNEBAGO) at the 3 pin UML. If power is present there is a problem with the red wire in the HWH harness.</p>	 <p style="text-align: center;"><b>REFER TO MP85.9413</b></p>  <p style="text-align: center;"><b>REFER TO MP85.9423</b></p>
<p>This section is concerned with the WINNEBAGO circuitry.</p> <p><b>Power is not present at the 3 pin UML.</b> Check for power on Terminal (30) of the Accessory relay. If power is not present there is a problem with the WINNEBAGO wire marked "1WK", the 15 amp fuse or the wire marked "CA".</p> <p><b>If power is present on Terminal (30),</b> Check Terminal (85). If power is present, there is a problem with the WINNEBAGO wire marked "LD" or the accessory power supply.</p> <p>If power is present on Terminal (85), check the ground on Terminal (86). Then check for power on terminal (87). If there is no power on Terminal (87) replace the relay. If there is power, the problem is with the WINNEBAGO wire marked "WK".</p>	 <p style="text-align: center;"><b>REFER TO MP85.9413</b></p>  <p style="text-align: center;"><b>REFER TO MP85.9413</b></p>  <p style="text-align: center;"><b>REFER TO MP85.9413</b></p>	

**PROBLEM**

**SOLUTION**

**FIGURES**

**Part 2**  
The pump will not run when the room extension switch is pushed toward Extend or Retract

**NOTE :** The ignition must be in the "ACC" position. The leveling system panel must be on and a red "Jack Down warning light" must be on.

**Run the leveling system. If the pump runs go to part B of the solution. If the pump does not run start at part A.**

**A.** Check for a +12 power on Terminals (1) and (3) of the pump relay.

**If there is no power on Terminal (3) :** Check the connection, battery cable and battery.

**If there is no power on Terminal (1) :** Check for power at the back of the leveling panel on the pump pin. If power is not present replace the panel. If power is present repair the blue wire.

**If power is present on Terminals (1) and (3) :** Ground Terminal (2). If the pump does not run check for +12 power on terminal (4) white grounding Terminal (20). If power is present check that the pump is properly grounded. If it is replace the pump. If power is not present on Terminal (4), replace the pump relay.

**B. If the pump works properly for the leveling system.** Check that the orange wire at the pump relay is connected properly.

Using a test light hooked to +12, check for ground on the white wire of the 6 pin UML connector supplied by HWH. If no ground is present, there is a problem with the harness. If there is a ground, check the number (2) pin on the room control switch. If there is no ground there is a problem with the WINNEBAGO wire marked "DX". If ground is present, check pins (1) and (3) for ground while pushing the room control switch. If ground is not present, replace the switch. If ground is present, check for ground at the 6 pin UML on the WINNEBAGO wire marked "DW" while pushing the button. If ground is present there is a problem with the orange wire in the HWH harness. If there is no ground the problem is with the WINNEBAGO wire marked "DW".

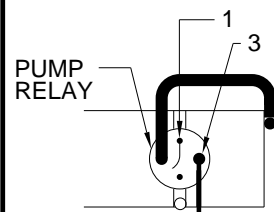

**REFER TO MP85.9417**

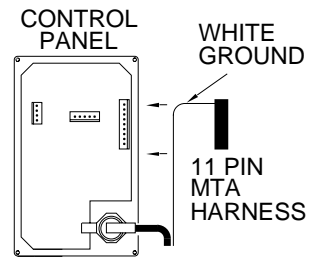

**REFER TO MP85.9417**

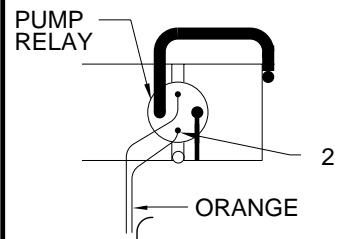

**REFER TO MP85.9417**

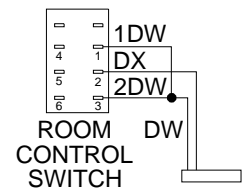

**ROOM CONTROL SWITCH**

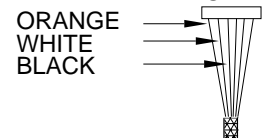

**REFER TO MP85.9413**

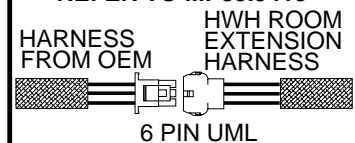

**REFER TO MP85.9423**

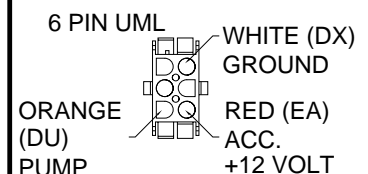

**REFER TO MP85.9423**

**PROBLEM**

**SOLUTION**

**FIGURES**

**Part 3**  
**The pump runs but the room will not extend.**

a. The pump runs under no load.

The retract valve is open. Make sure the solenoid valve "T" handle is closed. Check for +12 power on the black wire. If power is not present replace the retract valve.

If there is power on the black wire, check the number (4) terminal on the room control switch, while pushing the switch toward the "EXTEND" position. If there is power, replace the switch. If there is no power on the number (4) terminal, the WINNEBAGO wire marked "DU" or the black wire in the HWH harness is shorted to a +12 supply.

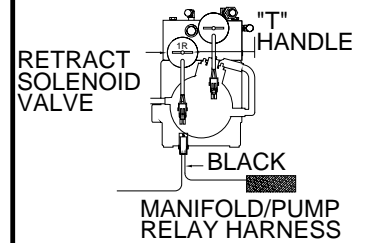

**REFER TO MP85.9437**

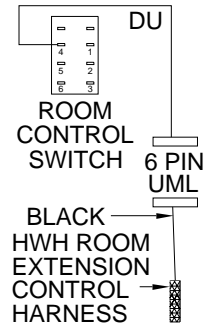

**REFER TO MP85.9413**

b. The pump runs under a load.

The extend solenoid valve is not opening. While pushing the room control switch toward "EXTEND", check between the yellow and white wire of the extend valve plug for +12 power. If power is present, replace the extend solenoid valve. If power is not present, check between the yellow wire and ground. If power is present, repair the white wire in the plug.

**Power is not present on the yellow and white wire of the extend valve plug.**

While pushing the room control switch toward "EXTEND", check for power on Terminal 6 of the room control switch. If power is present, there is a problem with the WINNEBAGO wire marked "DR" or the yellow wire in the HWH harness. If there is no power, check Terminal 5 of the room control switch. The switch does not have to be pushed. If there is power on Terminal 5, the switch needs to be replaced.

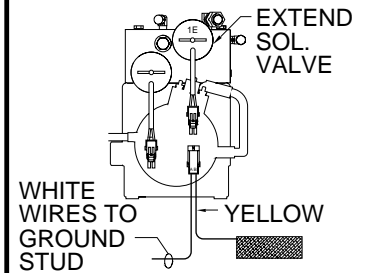

**REFER TO MP85.9437**

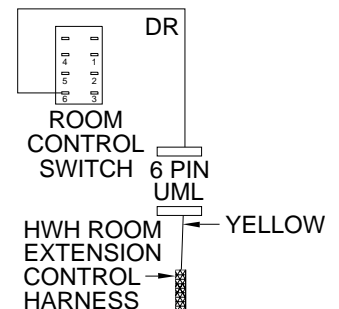

**REFER TO MP85.9413**

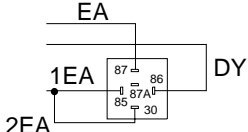
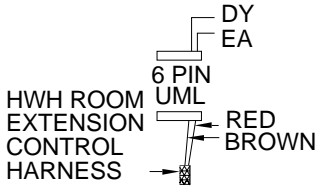
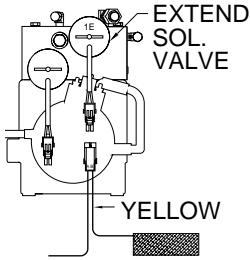
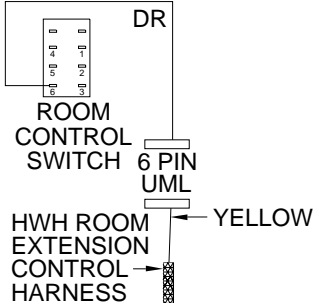
PROBLEM	SOLUTION	FIGURES
<p>3b. continued</p>	<p><b>There is no power to the room control switch.</b> Check Terminals (30) and (85) of the slide out relay. If power is not present, there is a problem with the WINNEBAGO wire marked "EA" or the red wire in the HWH harness. If there is power on Terminals (30) and (85) check that Terminal (86) has a ground. If there is no ground, check that a red "Jack Down Warning Light" is on. If a light is on, there is a problem with the WINNEBAGO wire marked "DY" or the brown wire of the HWH harness.</p> <p>If Terminal (86) has a ground check Terminal (87) for +12 power. If there is no power, replace the slide out relay. If there is power on Terminal (87), the problem is with the WINNEBAGO wire marked "EB".</p>	 <p>SLIDE OUT RELAY REFER TO MP85.9413</p>  <p>HWH ROOM EXTENSION CONTROL HARNESS REFER TO MP85.9413</p>
<p><b>Part 4</b> <b>The room will extend but not retract.</b></p> <p>4a. The pump runs under no load.</p>	<p>The extend valve is open. Make sure the solenoid "T" handle is closed. Check for +12 power on the yellow wire. If power is not present, replace the extend valve.</p> <p>If there is power on the yellow wire, check the (6) terminal on the room control switch while pushing the switch towards "RETRACT". If there is power replace the switch. If there is no power on the (6) terminal, the WINNEBAGO wire marked "DR" or the yellow wire in the HWH harness is shorted to a +12 supply.</p>	 <p>EXTEND SOL. VALVE REFER TO MP85.9437</p>  <p>ROOM CONTROL SWITCH HWH ROOM EXTENSION CONTROL HARNESS REFER TO MP85.9413</p>

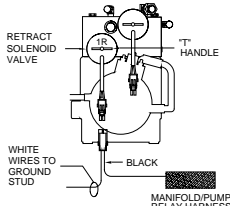
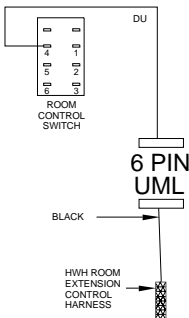
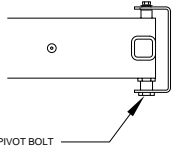
PROBLEM	SOLUTION	FIGURES
<p>4b. The pump runs under a load.</p>	<p>The retract solenoid valve is not opening. While pushing the room control switch toward "RETRACT", check between the black and white wires of the retract valve plug for +12 power. If power is present replace the retract solenoid valve. If power is not present check between the black wire and ground. If power is present, repair the white wire in the plug.</p> <p><b>Power is present on the black and white wire of the retract valve plug.</b> Check for power on Terminal (4) of the room control switch, while pushing toward "RETRACT". If power is present, there is a problem with the WINNEBAGO wire marked "DU" or the black wire of the HWH harness. If there is no power on Terminal (4), replace the switch. Pushing toward "RETRACT". If power is present, there is a problem with the WINNEBAGO wire marked "DU" or the black wire of the HWH harness. If there is no power on Terminal (4), replace the switch.</p>	 <p><b>REFER TO MP85.9437</b></p>  <p><b>REFER TO MP85.9413</b></p>
<p><b>Part 5</b> The room moves erratically from side to side (walking) as it extends or retracts (dual cylinder room extensions only).</p>	<p>Check that the pivot bracket is free to pivot. Vertical clearance must be between 0.030 and 0.120 inches. Check that the inner tubes are free of paint or undercoating. Check that the left cylinder hydraulic lines are not wire tied to the room closer than 12 inches to the rack sensing valve support arm. (SEE MP45.9415)</p> <p>Check that the strike plate is mounted solidly to the room, and that the rack sensing valve plunger is properly positioned on the strike plate. Check that the plunger is not bent. (SEE MP35.9410) Check that the room itself is not binding on seals or other interferences. Then replace the rack sensing valve. (SEE MP45.9420)</p>	<p><b>REFER TO MP45.9415</b></p>  <p><b>REFER TO MP35.9410</b> <b>REFER TO MP45.9420</b></p>
<p><b>Part 6</b> The ends of the room do not move at an equal distance from the vehicle.</p>	<p>The rack sensing valve needs to be adjusted. See MP45.9420 for valve adjustment procedures.</p>	<p><b>REFER TO MP45.9420</b></p>

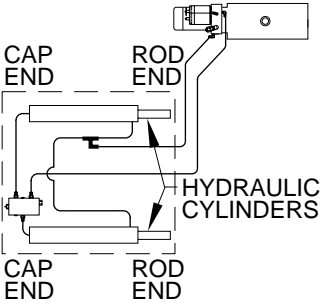
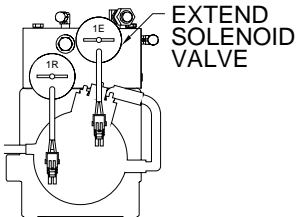
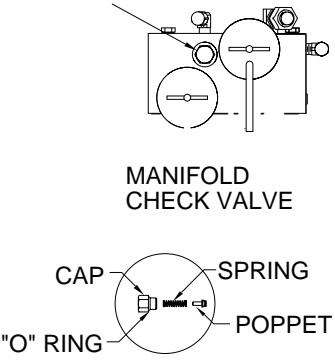
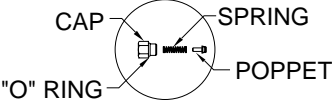
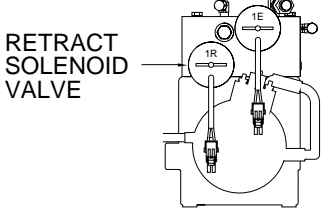

PROBLEM	SOLUTION	FIGURES
<p><b>Part 7</b> The room creeps out after being retracted.</p>	<p>The following deals with either single or dual cylinder room extensions. There are three possibilities:</p> <ul style="list-style-type: none"> <li>A. An extend solenoid valve is leaking.</li> <li>B. A room extension cylinder has an internal leak.</li> <li>C. The manifold check valve is leaking.</li> </ul> <p><b>NOTE :</b> If the room creeps out 1" or less, the problem is most likely the check valve.</p> <p>Retract the room completely. Remove the hydraulic line for the cap end of the cylinder at the manifold. Hold the line with the hose end in an upright position. Press the rocker switch for that room to the RETRACT position.</p>	 <p>CAP END ROD END HYDRAULIC CYLINDERS CAP END ROD END ROOM EXTENSION <b>REFER TO MP65.9425</b></p>
	<p>If fluid flows from the manifold fitting, the extend solenoid valve needs to be changed.</p>	 <p>EXTEND SOLENOID VALVE <b>REFER TO MP85.9437</b></p>
	<p>If no fluid flows from either the hose end or the manifold fittings, inspect the manifold check valve. There is a spring below the cap. DO NOT lose the spring. Check for cuts on the poppet o-ring. Check the poppet and cap for burrs. The poppet should easily slide in the cap.</p>	<p>MANIFOLD CHECK VALVE</p>  <p>MANIFOLD CHECK VALVE</p>  <p>CAP SPRING "O" RING POPPET <b>REFER TO MP85.9437</b></p>
	<p>If the check valve is OK, or if fluid flows from the hose end, the room extension cylinder should be replaced. See MP45.9415</p>	<p><b>REFER TO MP45.9415</b></p>
<p><b>Part 8</b> The room creeps back in after being extended.</p>	<p>Replace the retract solenoid valve for that room extension. This is the only possibility that would cause this problem.</p>	 <p>RETRACT SOLENOID VALVE <b>REFER TO MP85.9437</b></p>

**PROBLEM****SOLUTION****FIGURES****Part 9**

**The room does not seal tightly when fully retracted or extended.**

The room stops need to be adjusted. See the adjustment section of MP45.9415

**REFER TO MP45.9415**

**MANUAL ROOM RETRACT PROCEDURE**  
**USE ONLY WHEN ROOM CANNOT BE RETRACTED WITH THE ROOM CONTROL SWITCH OR THE MANUAL RETRACT WINCH.**  
**THIS SHOULD BE DONE BY A CERTIFIED TECHNICIAN ONLY.**  
**CONTACT HWH CORPORATION FOR ASSISTANCE AT (1-800-321-3494).**

When extending or retracting the room, if one side of the room does not move, release the room control switch immediately. The rack sensing valve plunger (1, FIGURE 1) may be stuck, bent or not touching the strike plate (2, FIGURE 1).

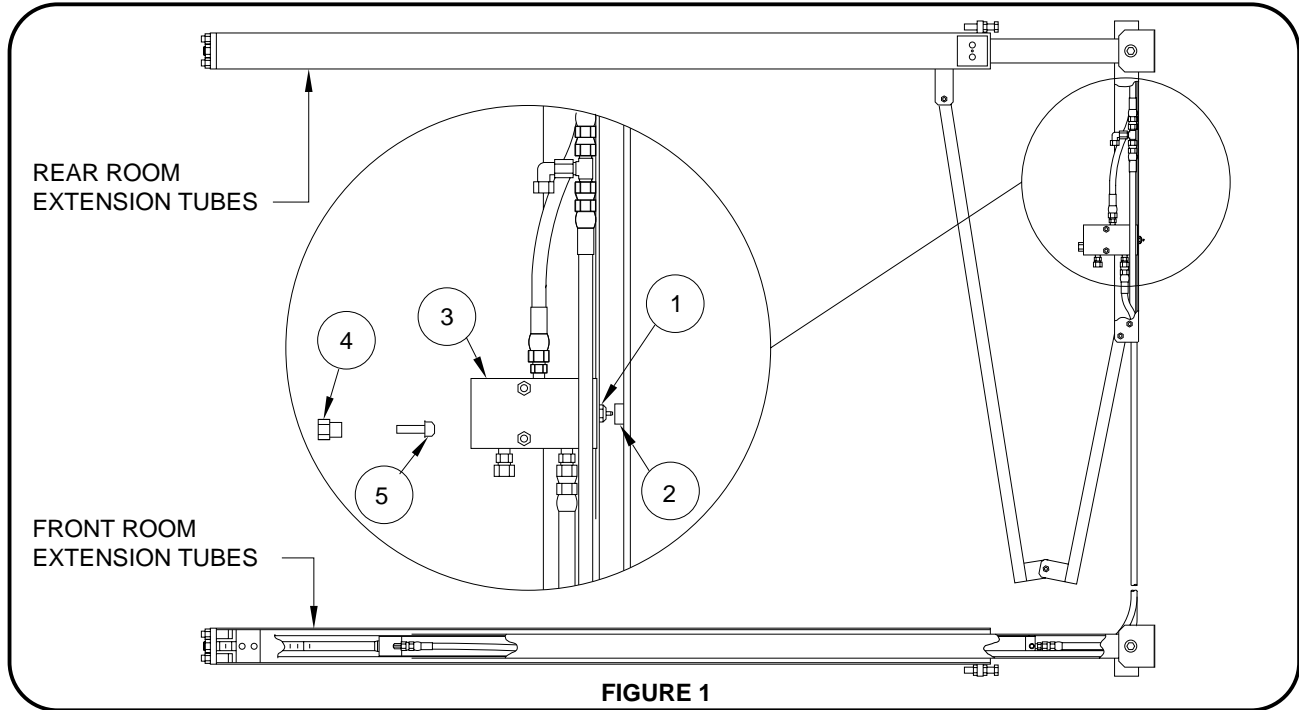
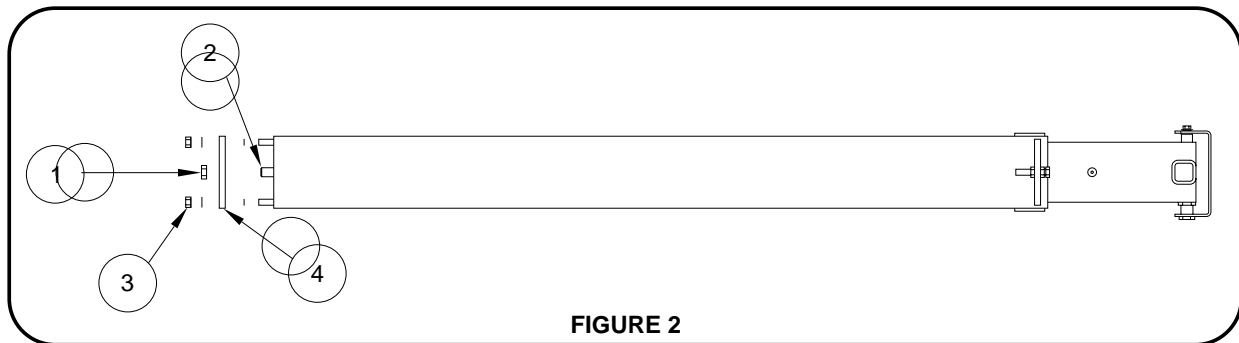

**FIGURE 1**

**ROOM IN EXTENDED POSITION**

Refer to page MP35.9490 in the Operator's Manual or the repair manual, and try to manually retract the room, if it is extended. If the manual winch provided will not retract the room, **DO NOT USE ALTERNATE DEVICES SUCH AS A POWER WINCH.** If possible repair the rack sensing valve (3, FIGURE 1) before retracting the room. If repair is not possible, release the pressure on the manual retract winch. Remove the check valve cap (4, FIGURE 1) from the back of the rack sensing valve. Remove the check valve poppet (5, FIGURE 1). Replace the check valve cap. Retract the room using the manual retract winch according to MP35.9490. **DO NOT** use the room extension until the rack sensing valve has been replaced. Leave the manual winch in place and have the room extension repaired.

**CAUTION :** ROOM EXTENSION SOLENOID VALVE "T" HANDLES MUST BE IN THE OPEN POSITION WHEN THE MANUAL RETRACT WINCH IS CONNECTED. **DO NOT** USE THE ROOM EXTENSION OR LEVELING SYSTEM WHEN THE ROOM EXTENSION HYDRAULIC HOSES ARE DISCONNECTED.



**FIGURE 2**

**ROOM IN RETRACTED POSITION**

If one side of the room will not move while extending, repair the rack sensing valve before continuing. Remove the cylinder adjusting locknut (1, FIGURE 2). Turn the cylinder adjusting rod (2, FIGURE 2) clockwise as far as possible. If this is not enough room to work on the valve, remove the cylinder mounting plate nuts (3, FIGURE 2) and the cylinder mounting plate (4, FIGURE 2). The room can then be pulled out far enough to work on the rack sensing valve. Contact HWH Corporation, 1-800-321-3494, for the correct rack sensing valve and cylinder replacement and adjustment instruction sheets.

# MANUAL ROOM RETRACT PROCEDURE (WITH SOLENOID VALVES WITH VALVE RELEASE "T" HANDLES)

(USE ONLY WHEN THE ROOM WILL NOT RETRACT WITH THE ROOM CONTROL SWITCH)

## OVERVIEW

The room can be retracted manually if a hydraulic or electrical failure prevents the room from being retracted using the ROOM CONTROL SWITCH. For normal retract sequence see the ROOM RETRACT PROCEDURE.

**CAUTION:** THE MANUAL RETRACT WINCH IS EQUIPPED FOR MANUALLY RETRACTING THE ROOM ONLY. IT IS NOT TO BE USED FOR LIFTING OR ANY OTHER APPLICATION. HIGH FORCES ARE CREATED WHEN USING A WINCH, CREATING POTENTIAL SAFETY HAZARDS. FAILURE TO FOLLOW ALL CAUTIONS AND INSTRUCTIONS MAY CAUSE FAILURE OF THE MANUAL RETRACT WINCH OR CONNECTIONS RESULTING IN DAMAGE OR PERSONAL INJURY. MAINTAIN FIRM GRIP ON THE WINCH HANDLE AT ALL TIMES. NEVER RELEASE THE HANDLE WHEN RATCHET LEVER IS IN THE OFF POSITION AND THE WINCH IS LOADED. THE WINCH HANDLE COULD SPIN VIOLENTLY AND CAUSE PERSONAL INJURY. CHECK THE WINCH AND STRAPS FOR DAMAGE OR WEAR, AND CHECK FOR PROPER RATCHET OPERATION ON EACH USE OF THE WINCH. DO NOT USE IF DAMAGED OR WORN.

1. Retract jacks following the LEVELING SYSTEM RETRACT PROCEDURE.

**NOTE :** When manually retracting the room, make sure the jacks are retracted before retracting the room.

2. Locate the HYDRAULIC PUMP/MANIFOLD unit.

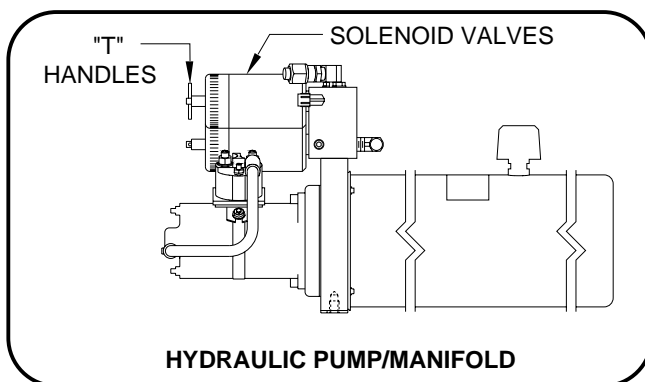

3. Open the SOLENOID VALVES by turning the "T" HANDLES counterclockwise.

**NOTE :** The "T" HANDLE may turn easily at first but will become more difficult to turn as an internal spring is compressed. Be sure to open both valves completely (about six turns of "T" HANDLE).

**NOTE :** The room may move slightly as the SOLENOID VALVES are opened and internal pressure is released.

4. Locate the MANUAL RETRACT WINCH and connect it to the room according to the vehicle manufacturer's instructions. To extend the WINCH STRAP firmly grasp WINCH HANDLE, place RATCHET LEVER in its OFF position, and slowly rotate the WINCH HANDLE counterclockwise, keeping a firm grip on the handle. When enough WINCH STRAP is extended, place the RATCHET LEVER in its ON position and slowly rotate the WINCH HANDLE clockwise until the RATCHET LEVER locks.

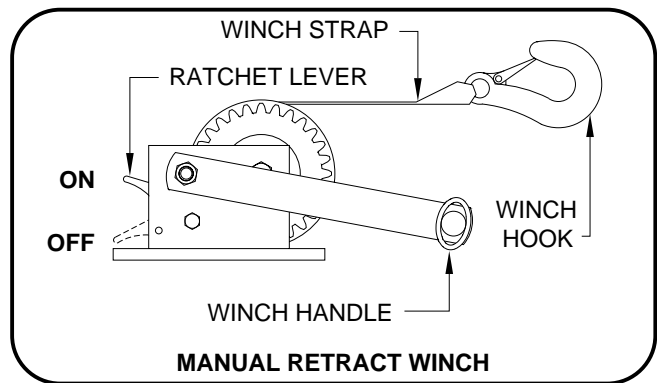

5. Slowly winch the room in by turning the WINCH HANDLE clockwise. The RATCHET LEVER should produce a loud, sharp, clicking noise.

**NOTE :** Winching the room in quickly will raise pressure in the hydraulic fluid and make winching more difficult.

**CAUTION:** OPERATE THE MANUAL RETRACT WINCH BY HAND POWER ONLY. IF THE WINCH CANNOT BE CRANKED EASILY WITH ONE HAND IT IS PROBABLY OVERLOADED. IF WINCHING BECOMES TOO DIFFICULT STOP AND CHECK FOR OBSTRUCTIONS OR RESTRICTIONS ON THE ROOM AND ROOM EXTENSION MECHANISM.

6. When the room is fully retracted, engage the room locking devices. Leave the retract winch in place.

**CAUTION:** THE ROOM EXTENSION SOLENOID VALVE "T" HANDLES MUST BE IN THE OPEN POSITION WHEN THE MANUAL RETRACT WINCH IS ENGAGED.

7. The system should be repaired before using again.

# CYLINDER REPLACEMENT ROOM EXTENSION ASSEMBLY DUAL CYLINDER ROOM EXTENSION

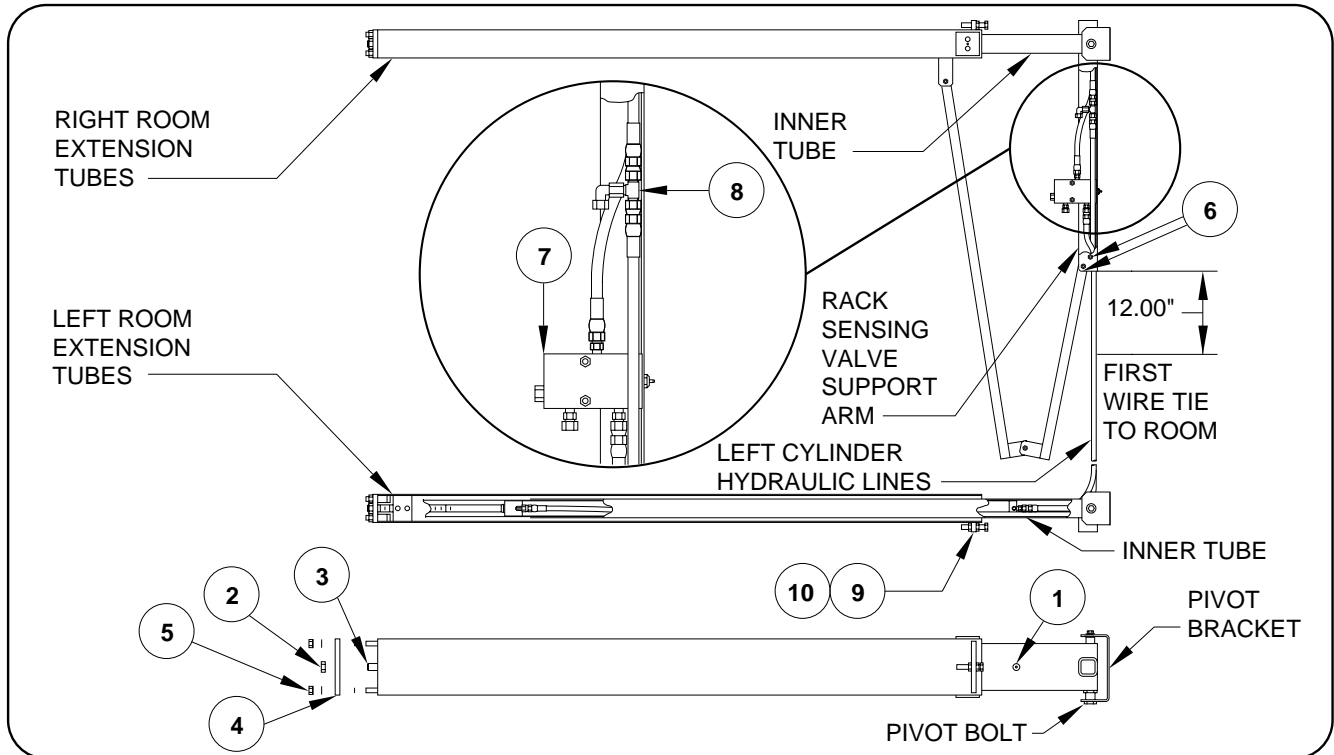

## CYLINDER REPLACEMENT

Extend the room until the cylinder mounting bolts (1) are visible. Make sure there is adequate room to work with the hose connections at the rack sensing valve. Open the extend and retract room extension solenoid valve "T" handles. Remove the cylinder adjusting lock nut (2). Measure the distance between the end of the cylinder adjusting rod (3) and the cylinder mounting plate (4). Add 1/4 inch to that measurement, this will allow for easy adjustment of the room after installing the new cylinder. Remove the two hose guide mounting bolts (6). (this is not necessary when removing the right cylinder). Remove the cylinder hoses from the sensing valve (7) and the tee fitting (8). Plug the hose ends and tie a wire to the two hoses, this will help when feeding the hoses back through the room extension tubes. Remove the cylinder mounting plate mounting nuts (5). Remove the cylinder assembly. **Before installing the new cylinder, clean all excess oil from the extension tubes. Swab the tube thoroughly with mild solvent and rags. Excess oil left in the tubes may leak giving the appearance of a leaky room cylinder or hose connection.**

Pull the rod out of the new cylinder approximately 1 1/2 feet. Some fluid will come out of the fittings. Move the hoses from the old cylinder to the new cylinder. **DO NOT** over tighten the fittings. Move the cylinder mounting plate to the new rod. Use the measurement from the old rod. Feed the hoses and new cylinder into the extension tube. Line up the cylinder mounting holes and replace the cylinder bolts (1). Reattach the hoses and hose guide. Push the rod in and attach the cylinder mounting plate. Close the room extension solenoid valves. Purge the air from the system by using the following steps. Retract the room completely. Extend the room 1 foot then retract the room completely. Extend the room 2 feet then retract the room completely. Extend the room fully then retract the room completely. Extend the room fully and hold the button toward extend for 5 seconds. Check for leaks. After replacement is complete check oil level in the tank.

**Tightening of hose ends:** If tightening a new hose end, make the hose end snug (finger tight) on the fitting, then tighten the hose end 1/3 turn (2 FLATS). If tightening an existing hose end, tighten the hose end to snug plus 1/4 turn (1 FLAT).

## CYLINDER ADJUSTMENT

Extend the room completely. Turn the cylinder adjustment rod (3) in or out until the room seals are properly compressed. Replace and tighten the cylinder adjusting lock nut (2). The in stop is adjusted by loosening the lock nut (9) and turning the adjusting nut (10) in or out until the seals are properly compressed. This adjustment should not have to be changed after replacing the cylinder.

**IMPORTANT:** Watch carefully that the room does not rack excessively or extend too far when operating the first time after replacing the cylinders.



**READ  
INSTRUCTIONS  
THOROUGHLY  
BEFORE  
PROCEEDING**

## ROOM EXTENSION RACK SENSING VALVE REPLACEMENT / ADJUSTMENT

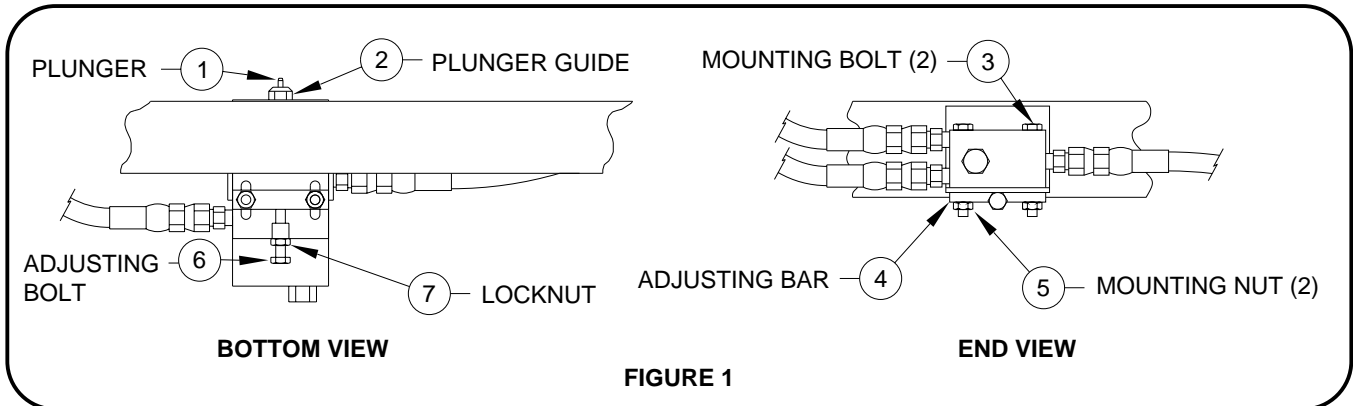

### REPLACEMENT

When replacing a rack sensing valve, the valve release "T" handles for both valves on the room extension manifold must be opened (counter clockwise) five to six turns to relieve pressure on the system. Only two solenoid valves for that room extension need to be opened.

Loosen the rack sensing mounting bolts. (3 & 4, FIGURE 1)  
Remove the adjusting bolt and lock nut. (6 & 7, FIGURE 1)  
Remove the three hydraulic lines from the valve. Remove the mounting bolts and valve adjusting bar. (5, FIGURE 1)  
Replace the valve but do not tighten the mounting bolts.  
Replace the hydraulic lines and the adjusting bolt and lock nut.

Adjust the valve so that approximately one half the plunger (1, FIGURE 1) is showing. Close the valve release "T" handles. Make the final adjustment of the rack sensing valve. (See the ADJUSTMENT procedure below). Tighten the mounting bolts and check for leaks and the fluid level in the power unit.

**Tightening of hose ends: If tightening a new hose end, make the hose end snug (finger tight) on the fitting, then tighten the hose end 1/3 turn (2 FLATS). If tightening an existing hose end, tighten the hose end to snug plus 1/4 turn (1 FLAT).**

### ADJUSTMENT

Extend the room 6 inches then retract. Do this several times to remove air from the system. Extend the room approximately 6 inches. Both sides of the room should move at an equal distance from the vehicle. **If the difference is approximately 1/2 inch or less do not adjust the valve.** The movement of the room can be adjusted by moving the

rack sensing valve in or out using the valve adjusting bolt. (6, FIGURE 1) Loosen the rack sensing valve mounting bolts (3&5, FIGURE 1) and the adjusting lock nut. (7, FIGURE 1) Do not tighten these until the adjustment is complete. Refer to FIGURE 2 or 3 depending on which side of the room is leading, for the proper adjustment of the valve.

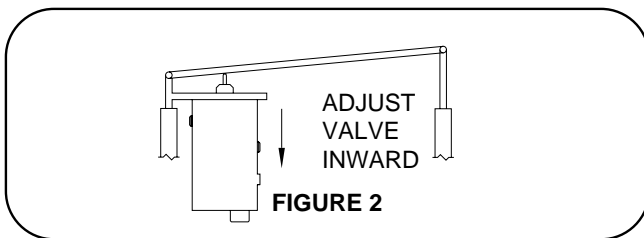

If the valve side of the room is moving at a closer distance to the vehicle (FIGURE 2) turn the adjusting bolt (6, FIGURE 1) counter clockwise 1 turn. **NOTE** : If the difference is minor, less than 1 turn may be appropriate. Extend the room an additional 12 inches. Retract the room that 12 inches and check the measurement. Repeat this procedure as necessary. The difference in the measurement should be 1/2 an inch or less. Tighten the mounting bolts and adjusting lock nut when the adjustment is complete.

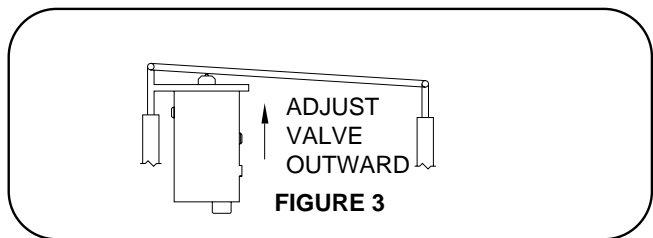

If the valve side of the room is moving at a greater distance from the vehicle (FIGURE 3) turn the adjusting bolt clockwise 1 turn. **NOTE** : If the difference is minor, less than 1 turn may be appropriate. Extend the room an additional 12 inches. Retract the room that 12 inches and check the measurement. Repeat this procedure as necessary. The difference in the measurement should be 1/2 an inch or less. Tighten the mounting bolts and adjusting lock nut when the adjustment is complete.

**REMEMBER** : If the room is racking from side to side while moving, adjusting the rack sensing valve will not fix the problem.

# HYDRAULIC CONNECTION DIAGRAM BI-AXIS VALVE LEVELING SYSTEM WITH DUAL CYLINDER ROOM EXTENSION SYSTEM W/RACK SENSING VALVE

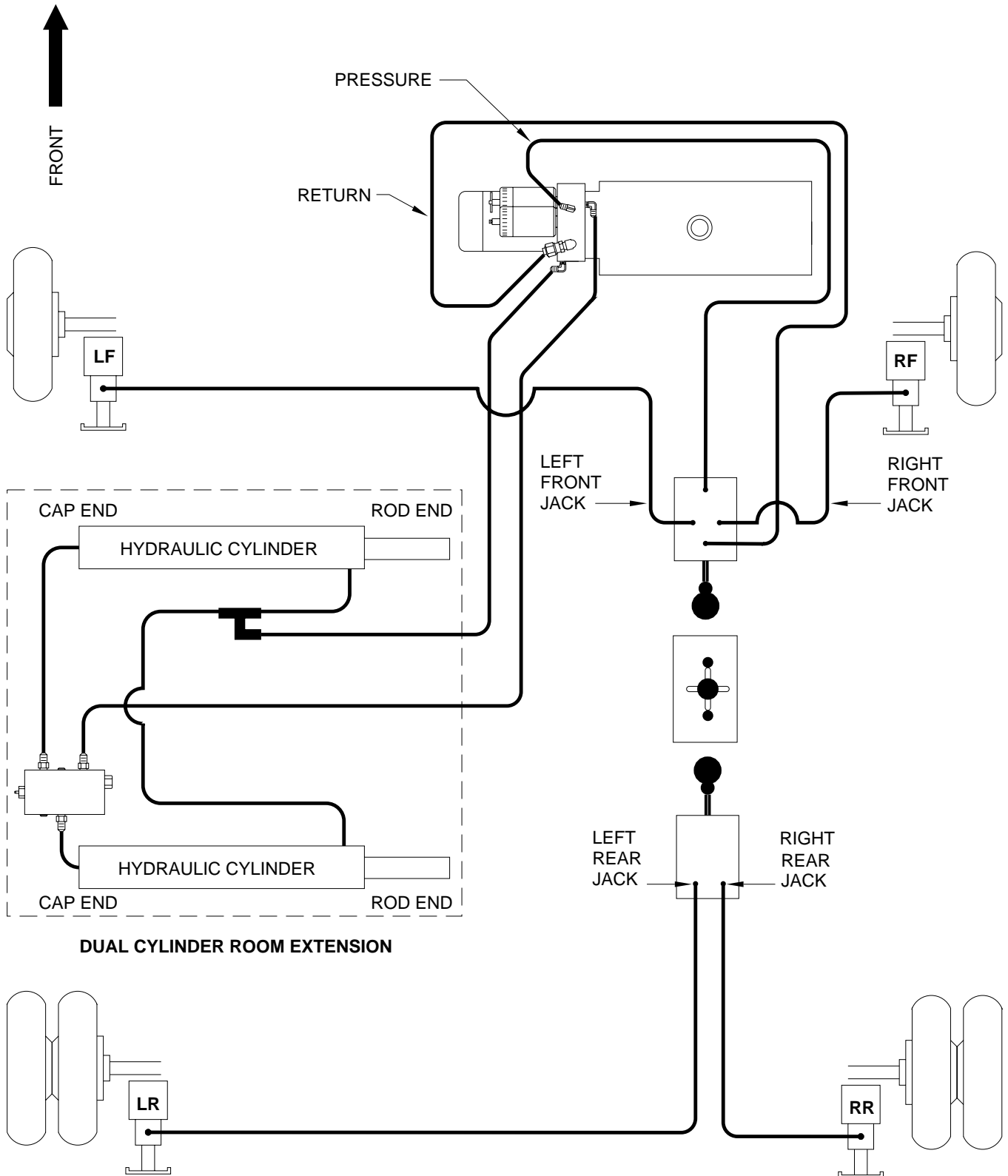

**HYDRAULIC FLOW DIAGRAM**  
**DUAL CYLINDER ROOM EXTENSION SYSTEM W/RACK SENSING VALVE**  
**STATIONARY POSITION**

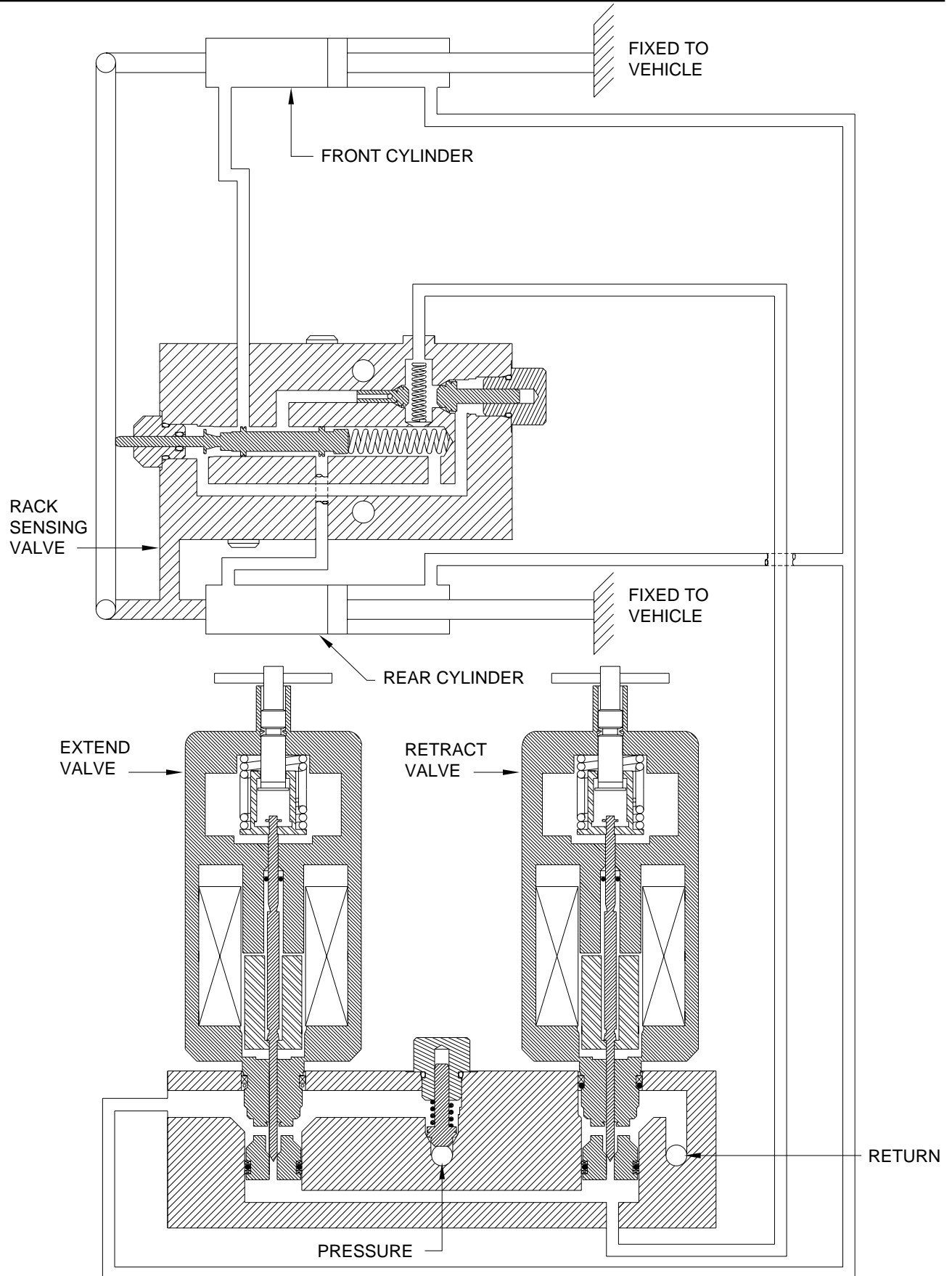



# ELECTRICAL CONNECTION DIAGRAM BI-AXIS VALVE LEVELING SYSTEM WITH ROOM EXTENSION

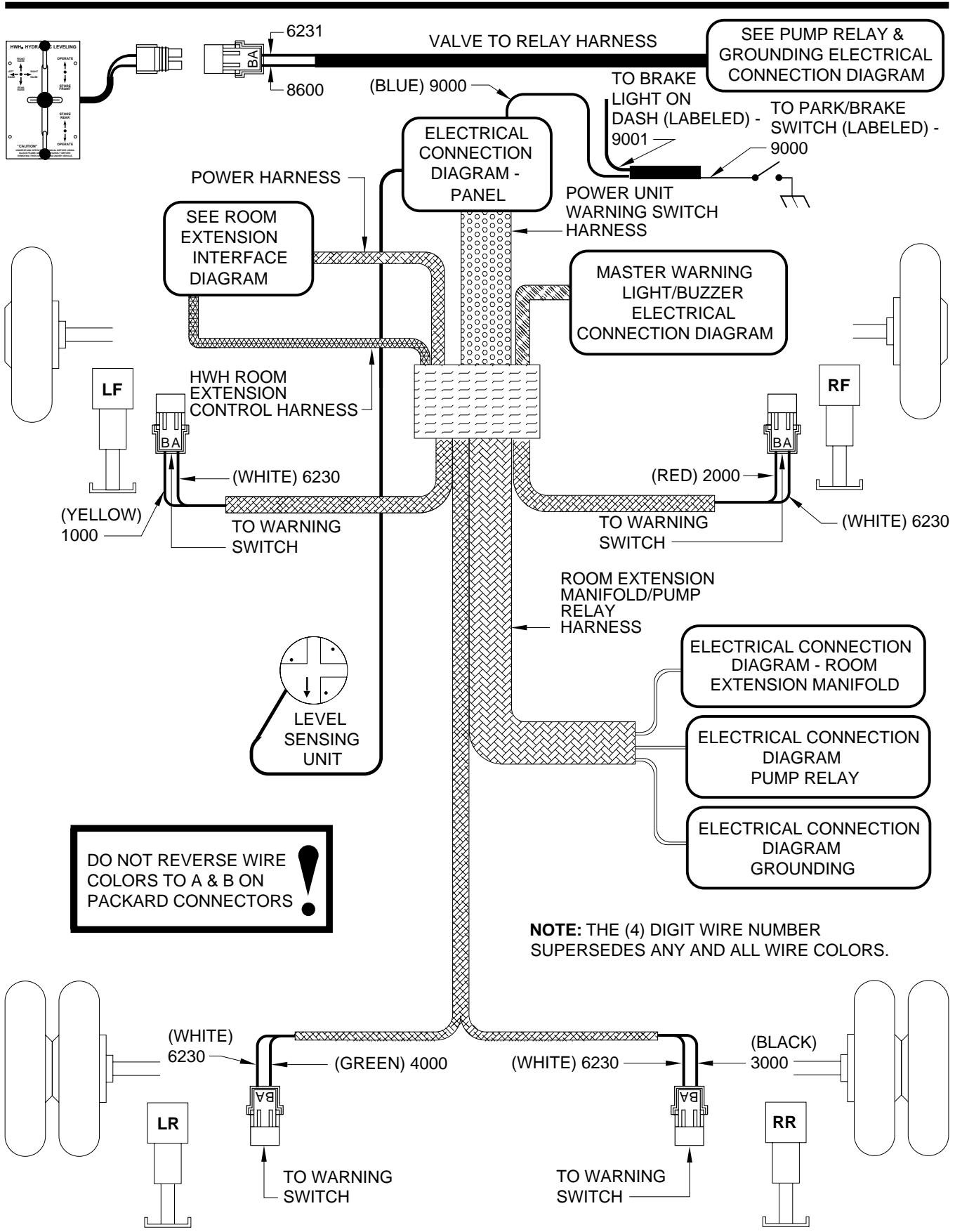

**DO NOT REVERSE WIRE COLORS TO A & B ON PACKARD CONNECTORS**

**NOTE: THE (4) DIGIT WIRE NUMBER SUPERSEDES ANY AND ALL WIRE COLORS.**

# ELECTRICAL CONNECTION DIAGRAM LEVELING SYSTEM WITH ROOM EXTENSION

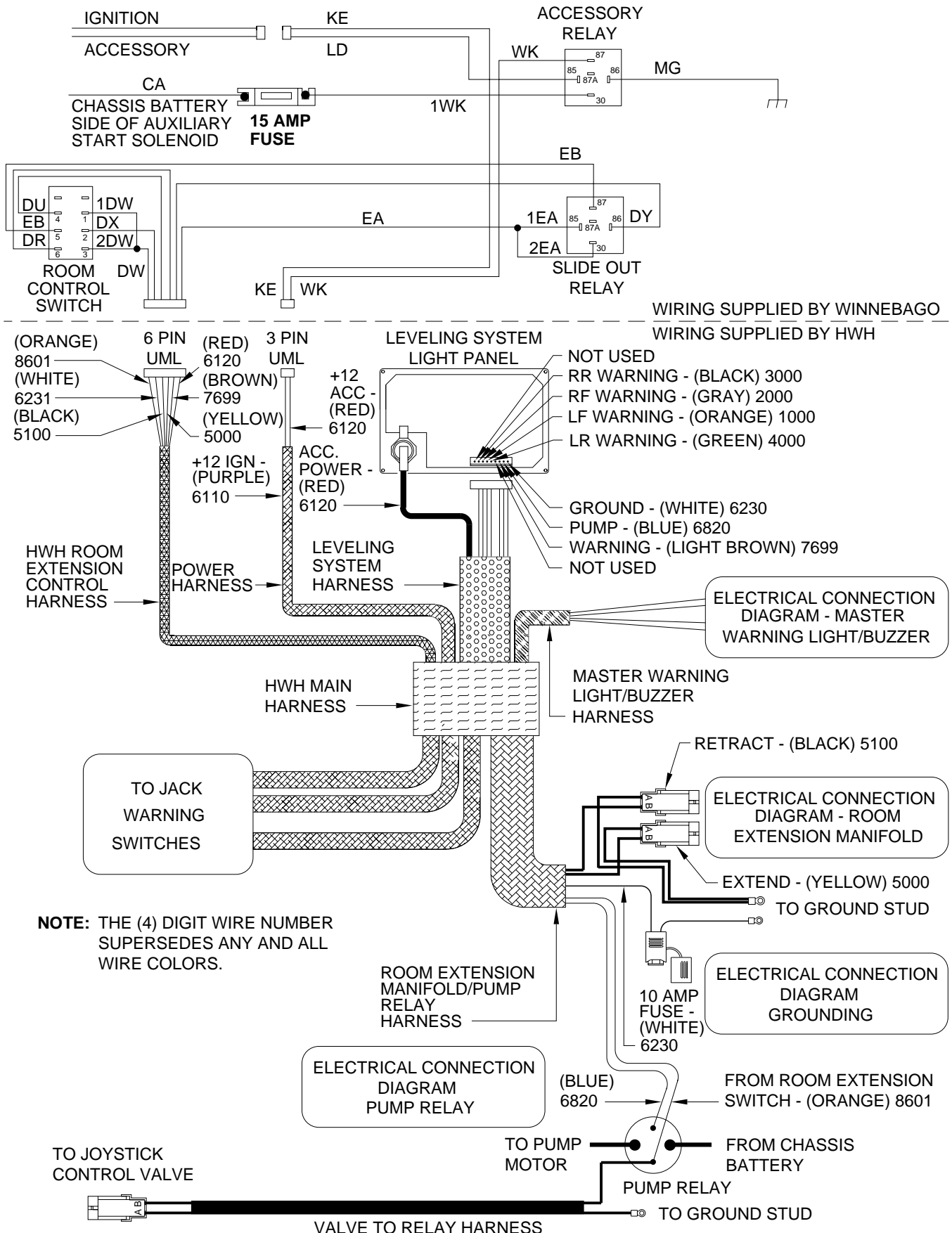

# ELECTRICAL CONNECTION DIAGRAM BI-AXIS VALVE LEVELING SYSTEM WITH ROOM EXTENSION

## PUMP RELAY

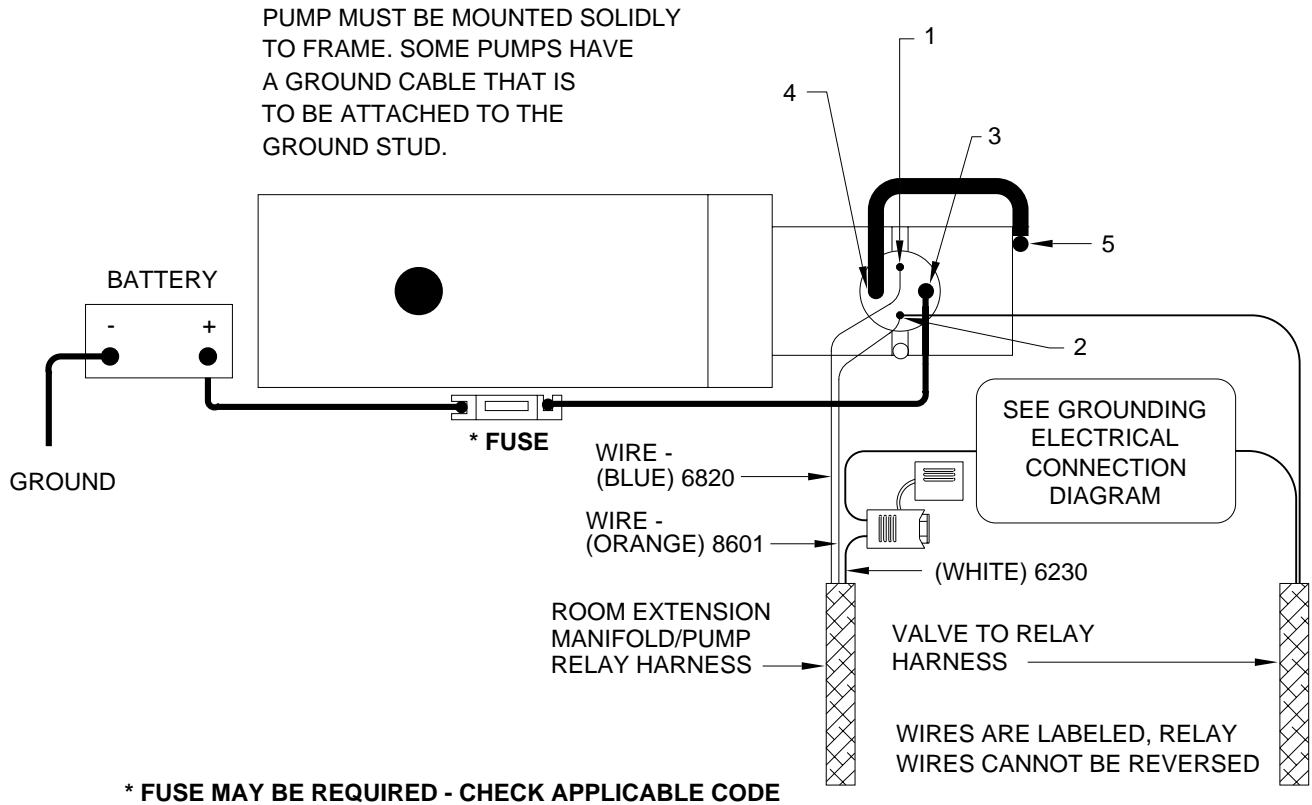

**NOTE:** THE (4) DIGIT WIRE NUMBER SUPERSEDES ANY AND ALL WIRE COLORS.

## PANEL

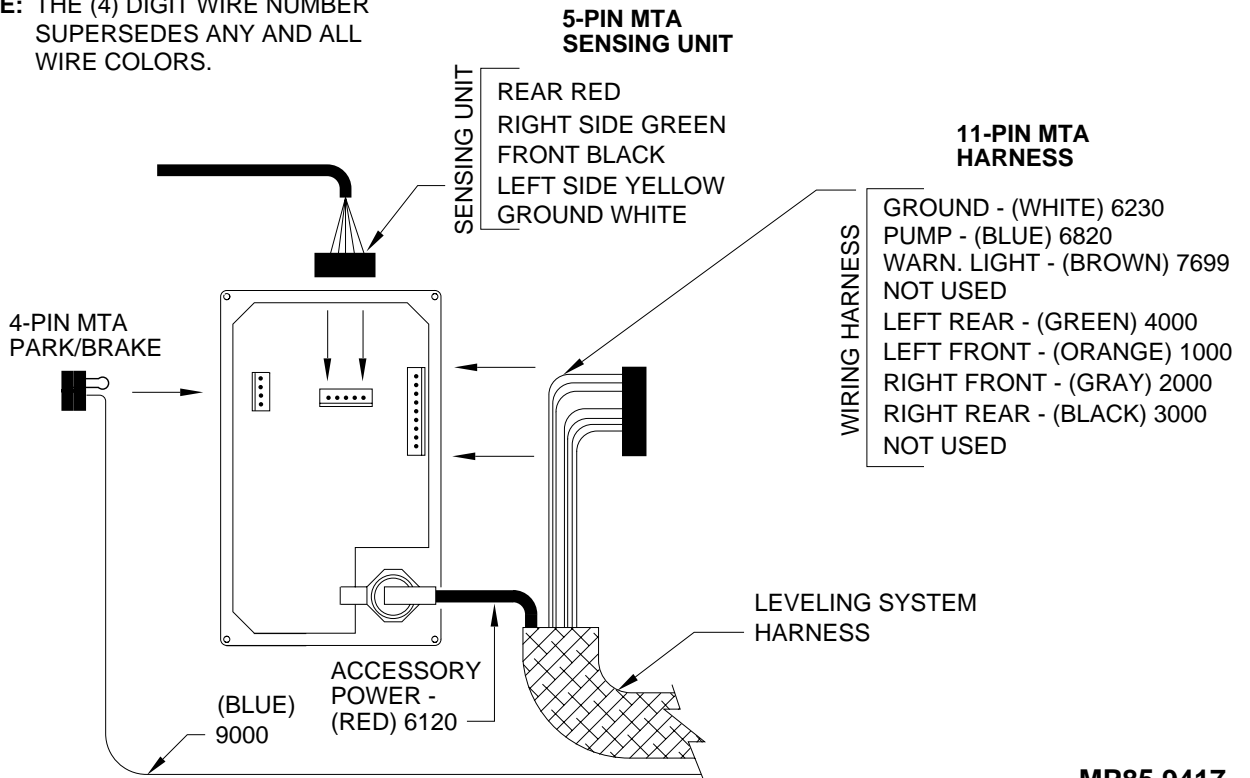

# ELECTRICAL CONNECTION DIAGRAM ROOM EXTENSION INTERFACE

## 6 PIN UML

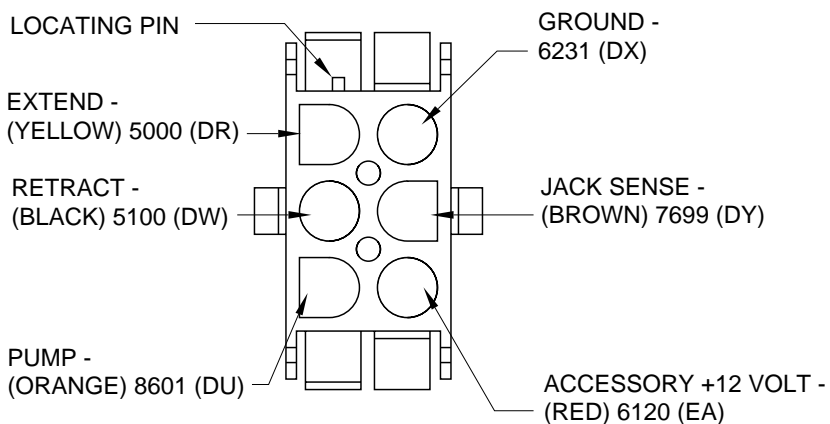
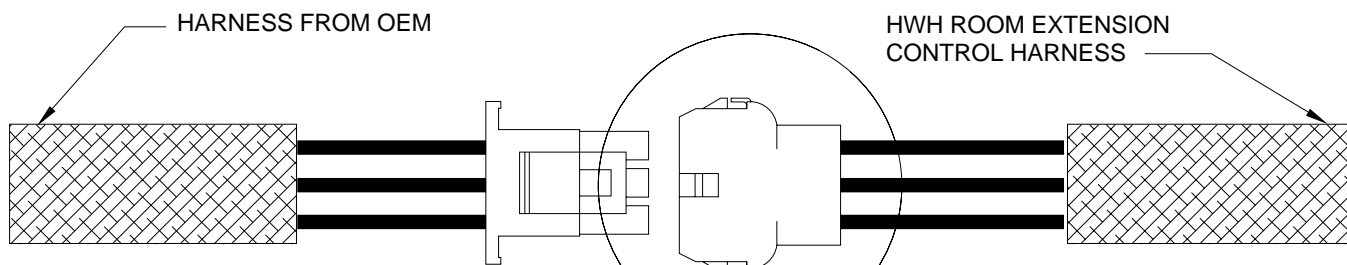

**NOTE:** THE (4) DIGIT WIRE NUMBER SUPERSEDES ANY AND ALL WIRE COLORS.

**DETAIL A**

## 3 PIN UML

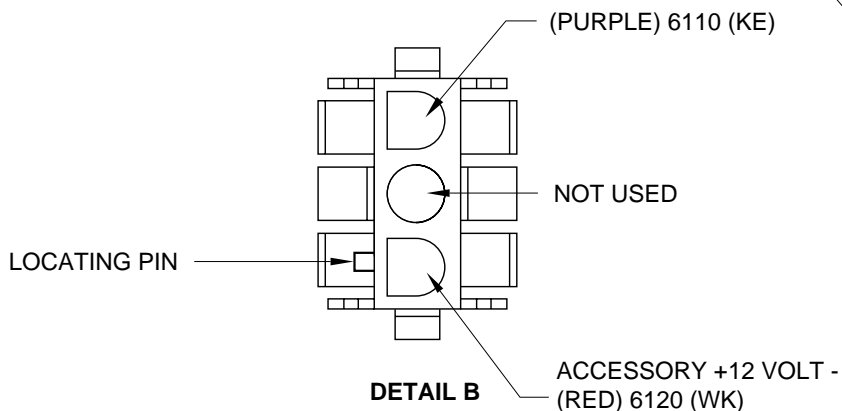
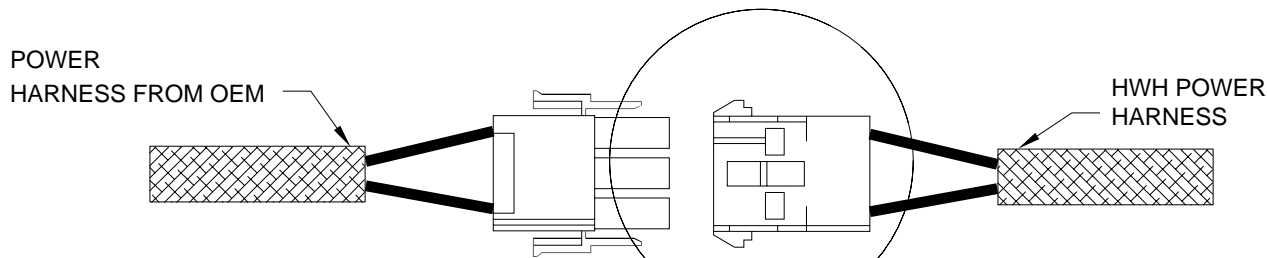

# ELECTRICAL CONNECTION DIAGRAM BI-AXIS VALVE LEVELING SYSTEM WITH ROOM EXTENSION GROUNDING AND ROOM EXTENSION MANIFOLD CONNECTION

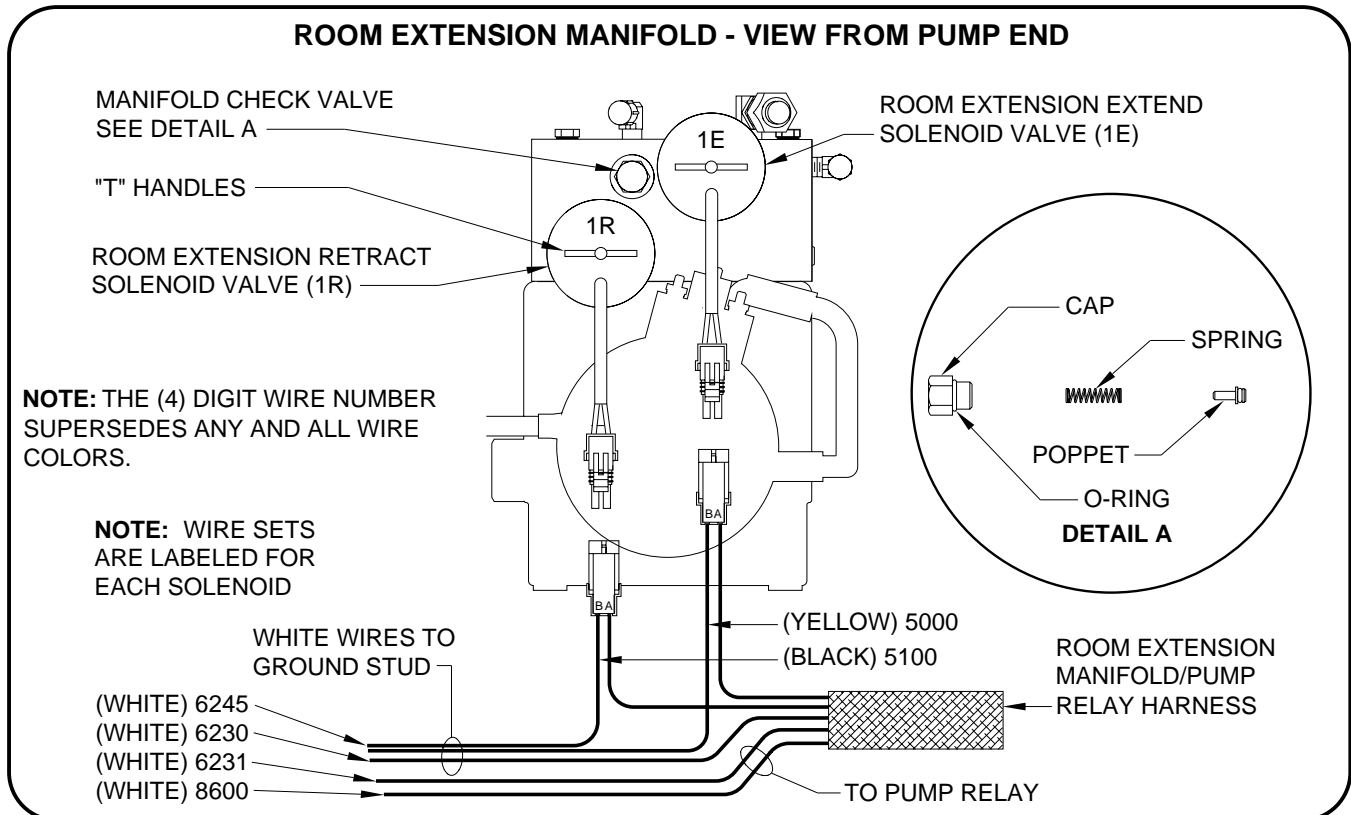
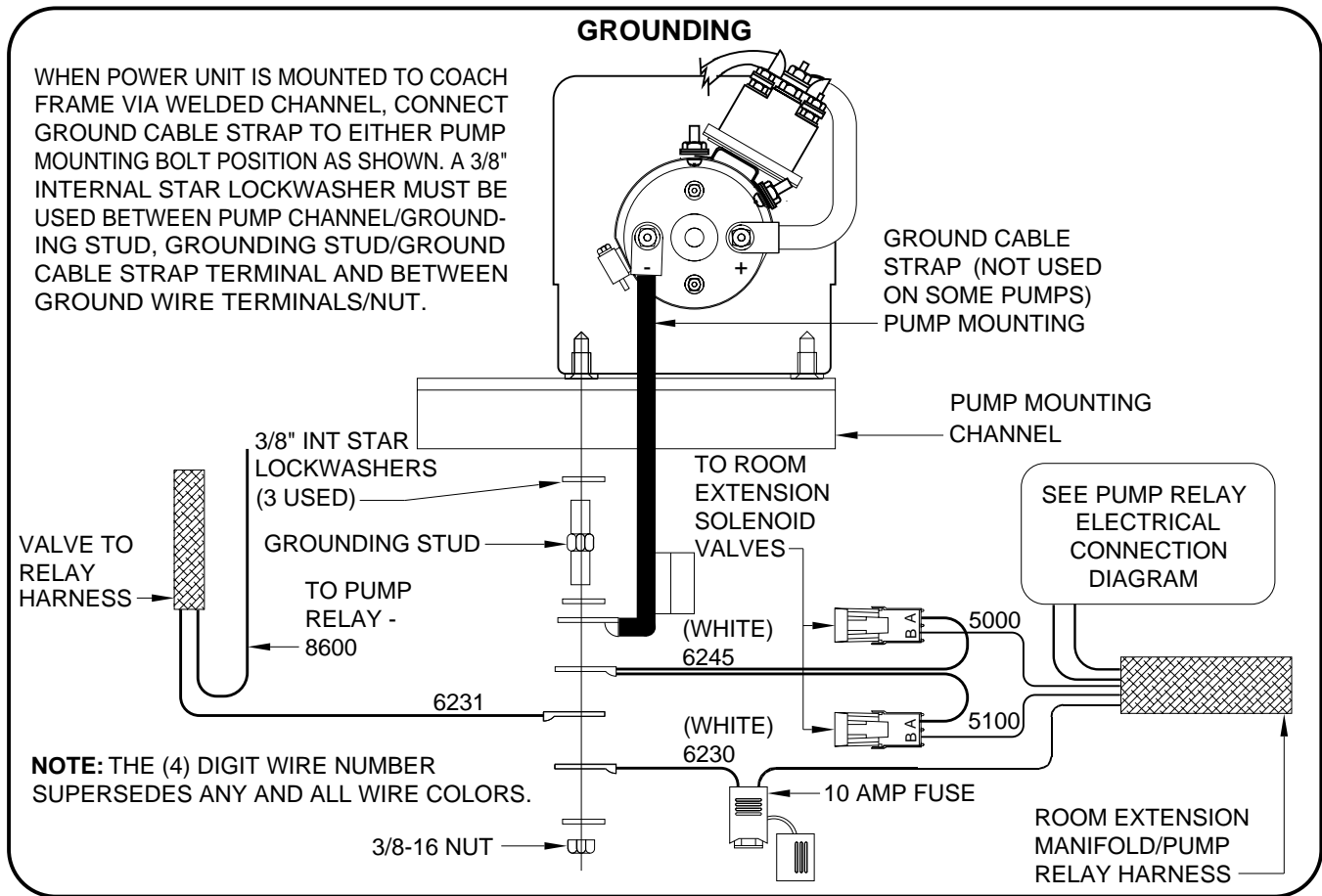

# ELECTRICAL SCHEMATIC

## 200 SERIES BI-AXIS LEVELING SYSTEM WITH HYDRAULIC ROOM EXTENSION SYSTEM

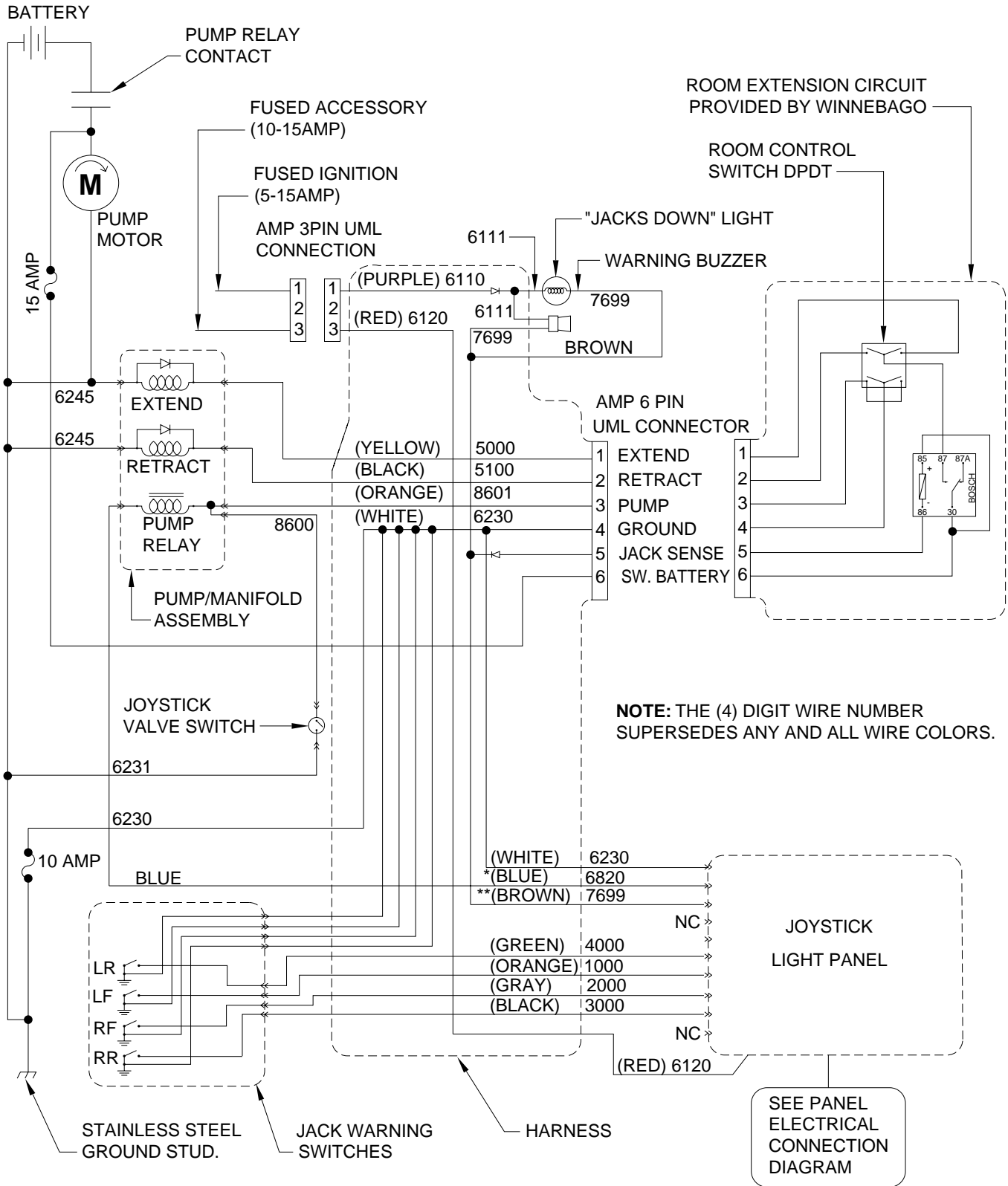

\*NOTE: BLUE IS A POSITIVE SIGNAL WHEN JOYSTICK PANEL IS ON.

\*\*NOTE: BROWN IS A NEGATIVE SIGNAL WHEN A JACK IS DOWN.