



# REPAIR MANUAL

## HWH TOUCH PANEL-CONTROLLED LEVELING SYSTEM 310 SERIES

FEATURING:

**TOUCH PANEL BI-AXIS<sup>®</sup> CONTROL**  
**CENTRAL GROUNDING**  
**KICK-DOWN OR STRAIGHT-ACTING JACKS**  
**WITH OR WITHOUT AIR DUMP**

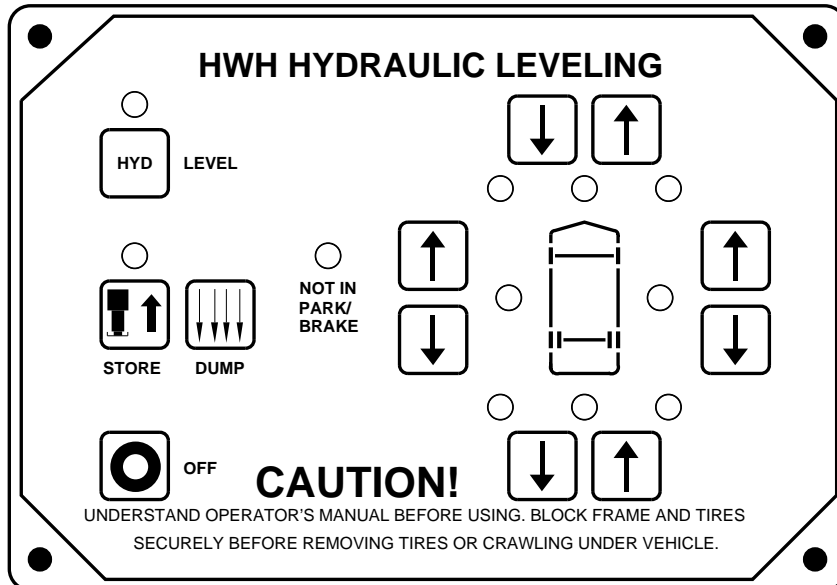

**HWH CORPORATION**  
**(ON I-80, EXIT 267 SOUTH)**  
**2096 MOSCOW ROAD**  
**MOSCOW, IOWA 52760**  
**(800) 321-3494 / (563) 724-3396**  
**INTERNET: <http://www.hwhcorp.com>**

ML13514/MI91.0014  
07MAR01

# SECTION 1

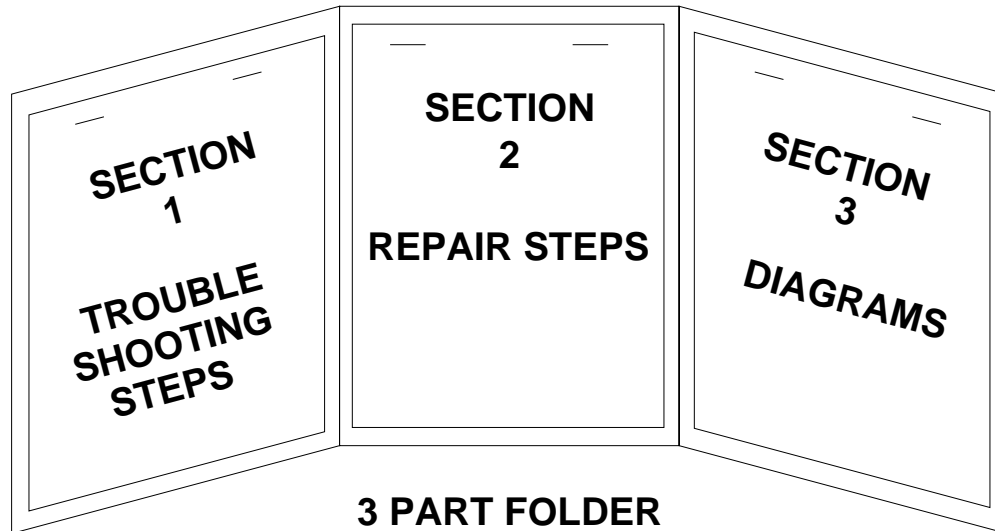

## HOW TO USE MANUAL

This manual is written in three sections. Section 1 is the Trouble Shooting Steps. Section 2 is the Repair Steps. Section 3 is the Diagrams. Begin diagnosis of the system with Section 1, the Trouble Shooting Steps. This will give the correct operation and function of the system. When a malfunction is encountered, the Trouble Shooting Steps will direct you to the proper Repair Steps in Section 2, the Repair Steps. The Repair Steps are broken into 3 columns, Problem, Solution, and Diagram. In the proper part under Problems, find the symptom you have encountered. The testing and repair for that problem is in the Solution (center) column. Diagrams for a particular Problem and Solution are in the Diagram (right hand) column. This column will direct you to the proper diagram in Section 3, Diagrams, for a more detailed view.

Before beginning your repair, it is **IMPORTANT** to read the **CAUTIONS** and **NOTES AND CHECKS** in the first section, **TROUBLE SHOOTING STEPS**. In many cases this will save time and mistakes when trouble shooting a system.

This Repair Manual is offered as a guide only. It is impossible to anticipate every problem or combination of problems. This manual is written in sequential order of the proper operation of the system. The Trouble Shooting Steps must be followed in order to give correct diagnosis of the problem(s). For any problems encountered that are not addressed in this manual, contact HWH Corporation for assistance.

**NOTE: Diagrams in this manual are of typical systems. There may be plumbing or harness differences. In most cases this should not effect trouble shooting procedures.**

**PROCEED WITH TROUBLE SHOOTING GUIDE**



# TROUBLE SHOOTING

## CAUTIONS!

**BLOCK FRAME AND TIRES SECURELY BEFORE CRAWLING UNDER VEHICLE. DO NOT USE THE LEVELING JACKS OR AIR SUSPENSION TO SUPPORT VEHICLE WHILE UNDER VEHICLE OR CHANGING TIRES. VEHICLE MAY DROP AND OR MOVE FORWARD OR BACKWARD WITHOUT WARNING CAUSING INJURY OR DEATH.**

**WHEN ROUTING OR REROUTING HYDRAULIC HOSES AND WIRES, BE SURE THEY ARE NOT EXPOSED TO ENGINE EXHAUST OR ANY HIGH TEMPERATURE COMPONENTS OF THE VEHICLE.**

**THE JACKS MAY ABRUPTLY SWING UP WHEN THE FOOT CLEARS THE GROUND OR WHEN THE JACK REACHES FULL EXTENSION.**

**NEVER PLACE HAND OR OTHER PARTS OF THE BODY NEAR HYDRAULIC LEAKS. OIL MAY CUT AND PENETRATE THE SKIN CAUSING INJURY OR DEATH.**

**SAFETY CLASSES ARE TO BE WORN TO PROTECT EYES FROM DIRT, METAL CHIPS, OIL LEAKS, ECT. FOLLOW ALL OTHER SHOP SAFETY PRACTICES.**

**DO NOT OVER EXTEND THE REAR JACKS. IF THE WEIGHT OF THE VEHICLE IS REMOVED FROM ONE OR BOTH REAR WHEELS, THE VEHICLE MAY ROLL FORWARD OR BACKWARD OFF THE JACKS.**

## NOTES AND CHECKS

**Read and check before proceeding with Trouble Shooting Steps.**

**NOTE: HWH CORPORATION ASSUMES NO LIABILITY FOR DAMAGES OR INJURIES RESULTING FROM THE INSTALLATION OR REPAIR OF THIS PRODUCT.**

1. If the jacks cannot be retracted, see TROUBLE SHOOTING Step 8 for temporary measures. Make sure the manual retract valves are closed before trouble shooting.
2. The Trouble Shooting Guide must be followed in order. Problems checked for in one step are assumed correct and not checked again in following steps.
3. Check that the oil reservoir is full with the jacks in the fully retracted position.
4. Most coaches have more than one battery; one for the engine and the other(s) for the coach. The engine battery supplies power for the control box and hydraulic pump. DO NOT use the coach batteries to supply power to the pump. Batteries under no load should read 12.7 volts. Batteries must maintain good voltage under load. Batteries must be in good condition with no weak cells. The system will draw up to 200 amps. An alternator, convertor or battery charger will not supply enough power for the system to operate properly.
5. Proper grounding of all components is critical. See the electrical circuit for specific grounds required. Faulty grounds, especially for the control box, solenoid manifold or the pump assembly, may cause control box component damage and /or improper or erratic operation.

6. Do not replace the control box unless the Repair Steps say to replace it. Otherwise the malfunctions may damage the new control box.

**This manual is intended for use by experienced mechanics with knowledge of hydraulic and automotive electrical systems. People with little or no experience with HWH leveling systems should contact HWH technical service (800-321-3494) before beginning. Special attention should be given to all cautions, wiring, and hydraulic diagrams.**

**Special note: When installing a new control box, make sure the box is properly grounded before applying power to the system.**

**Tightening of hose ends: If tightening a new hose end, make the hose end snug (finger tight) on the fitting, then tighten the hose end 1/3 turn (2 FLATS). If tightening an existing hose end, tighten the hose end to snug plus 1/4 turn (1 FLAT).**

Suggested tools for trouble shooting the HWH leveling systems:  
JUMPER WIRES(UP TO 10 GAUGE)  
PRESSURE GAGE(3500 PSI MIN.)  
MULTI-METER  
12 VOLT TEST LIGHT

**PROCEED WITH THE TROUBLE SHOOTING STEPS ON THE FOLLOWING PAGE**



# TROUBLE SHOOTING STEPS

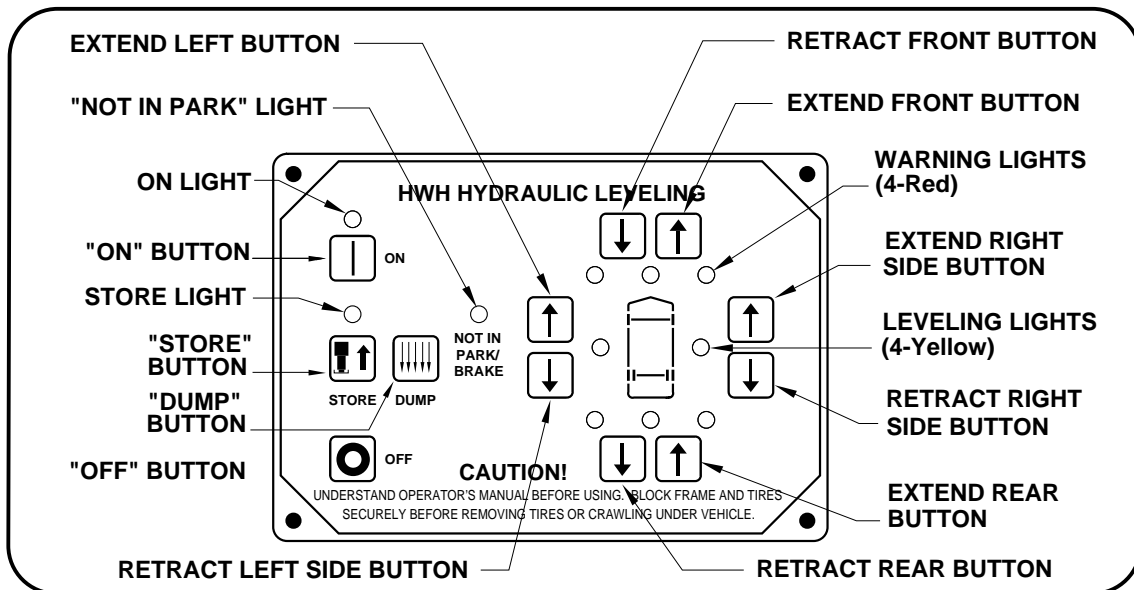

1. Make sure the transmission is in the recommended position for parking and the park brake is set. With the ignition switch off, there should be no power to the leveling system. If any touch panel lights are on or the pump is running, see Part 1 of the Repair Steps.

2. Turn the ignition switch to "ON". The touch panel should remain off. If this is not so, see Part 2 of the Repair Steps.

3. Turn the ignition to the "ACC" position. Push the "ON" (I) button. The red POWER ON light should glow steady. One yellow LEVELING light may be on. No other lights should be on. The pump should not run. If this is not so, see Part 3 of the Repair Steps.

The jacks operate in pairs, front, sides or rear. The up arrows are EXTEND buttons, and down arrows are RETRACT buttons.

If the vehicle has kick-down jacks, use the front and rear up arrows (EXTEND buttons) to kick the jacks vertical.

If the vehicle has straight-acting jacks, use any up arrows for the following tests.

**NOTE:** As jack pairs kick vertical, one jack may extend to the ground before the other jack moves to the vertical position. This is ok as long as the first jack does not lift the vehicle after touching the ground.

4. Push the front, then the rear EXTEND buttons to kick the jacks vertical or extend straight-acting jacks. The pump will come on, the jacks will kick vertical or extend, the individual red WARNING light for each jack will come on and the pump will shut off as the button is released. Kick-down jacks should remain in the vertical position. If any of this does not happen, see Part 4 of the Repair Steps.

5. **Air dump check.** The "DUMP" button is a momentary button. The "DUMP" button will only work with the panel on. Push and hold the "DUMP" button. The air should exhaust from the vehicle's suspension. Release the "DUMP" button. The vehicle should return to the proper ride height. If any of this does not happen, see Part 5 of the Repair Steps.

6. **Level sensing unit check.** Extend the jacks to the ground and put the coach in a level position. All yellow lights should be out. If a yellow light is on, adjust the sensing unit. Check that the sensing unit is positioned properly and mounted to a solid surface. If the sensing unit cannot be adjusted, yellow lights never come on or more than one yellow light comes on at a time, see Part 6 of the Repair Steps.

It is assumed at this point the system will level the coach properly and the level sensing unit is set. It is also assumed the red warning lights and yellow level lights are working correctly.

7. Turn the touch panel on. Push the "STORE" button. The red STORE light should come on. All four jacks will start to retract. Kick-down jacks will fold up when the foot of the jack clears the ground. When a kick-down jack is horizontal, the red warning light for that jack will go out. When a straight-acting jack is extended less than 2 inches, its red warning light will go out.

The foot of the jack should continue to retract completely into the cylinder. Two minutes after all the red lights go out, the system will shut off. If any of this does not happen, see Part 7 of the Repair Steps.

8. **Emergency jack retraction.** Each solenoid valve is equipped with a "T" handle release valve. Turn the handle counter clockwise approximately 3 turns or until the jacks start to retract. The oil will return to the reservoir and the jack should retract. After all the jacks are full retracted, turn the "T" handles clockwise until snug. See Part 8 of the Repair Steps.

# REPAIR STEPS

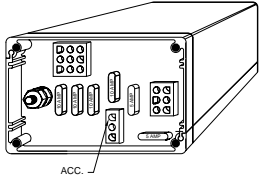
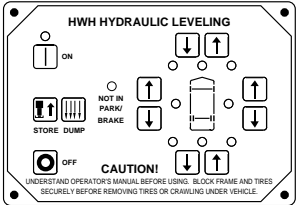
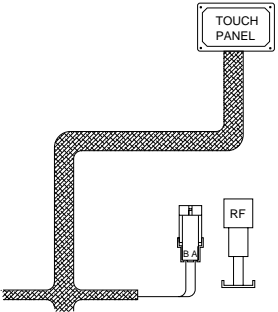
PROBLEM	SOLUTION	DIAGRAMS
<p><b>Part 1</b> With the ignition off and the park brake set.</p> <p>a. Touch panel has indicator lights on with the ignition switch off.</p>	<p>There should be no +12 power to the control box. Trace the (BROWN) 6120 wire in the 3 pin UML connector to its source. The wire should be connected to the accessory side of the ignition switch.</p>	 <p><b>REFER TO MP85.3024</b></p>
<p>b. The pump is running continuously.</p>	<p>Release the park brake. If the pump stops, replace the control box. If the pump continues to run, replace the pump relay.</p>	
<p><b>Part 2</b> With the ignition switch in the "ON" position:</p> <p>a. The touch panel has indicator lights on.</p>	<p>Push the "OFF" button on the touch panel. The ON light should go out. If the lights come back on when the "OFF" button is released, replace the touch panel.</p>	 <p><b>REFER TO MP85.3017</b></p>
<p>b. The master "JACKS DOWN" warning light and/or buzzer is on. (The jacks should all be in the store position.)</p>	<p>Push the "ON" (I) button one time. A red WARNING light on the touch panel should come on indicating a jack is down.</p> <p><b>(Continued on next page.)</b></p>	 <p><b>REFER TO MP85.3016</b></p>

# REPAIR STEPS

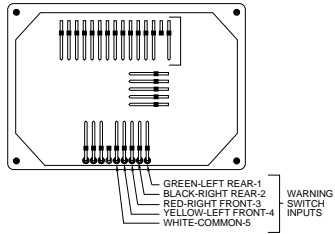
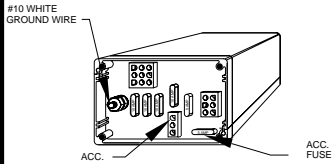
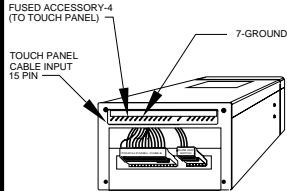
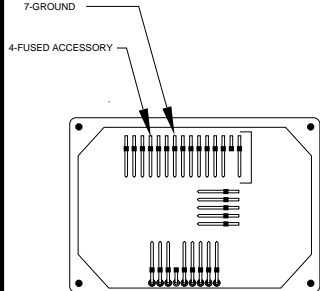
PROBLEM	SOLUTION	DIAGRAMS
<p><b>Part 2b</b> continued</p>	<p><b>If a red light comes on</b>, unplug the jack warning switch for that light. If the light goes out, replace the warning switch. If not, unplug the 5 pin MTA connector for warning switches at the touch panel. If the light goes out, the wiring harness is the problem. If not, replace the touch panel.</p> <p><b>If a red light does not come on</b>, check the wires to the master warning light. If they are ok, replace the touch panel.</p>	 <p style="text-align: center;"><b>REFER TO MP85.3017</b></p>
<p><b>Part 3</b> After pushing the "ON" (I) button:</p> <p>a. The red POWER ON light does not come on.</p>	<p><b>Check for +12 volts on the (BROWN) 6120 wire in the 3 pin UML connector.</b> If there is no power, trace the (BROWN) 6120 wire to its source and repair. If power is present on the (BROWN) 6120 wire, check the (WHITE) 6230 #10 wire connected to the ground stud on the control box. Make sure the connection is good and tight. Check that there is good ground on that wire.</p> <p><b>Check the ACC fuse.</b> If the fuse is blown, unplug the touch panel cable from the control box. Replace the fuse. If it blows, replace the control box. If it doesn't blow, unplug the touch panel cable from the touch panel and reconnect the cable to the control box. If the fuse blows, replace the touch panel cable. If it does not blow, replace the touch panel.</p> <p><b>NOTE:</b> Have the control box and touch panel plugged into the cable for this part.</p> <p><b>If there is power and ground to the control box and the ACC fuse is ok</b>, check pin 4 of the touch panel cable input at the control box for +12 volts. If +12 is not present, replace the control box. If +12 is present, check pin 4 of the touch panel cable connections at the touch panel. If +12 is not present, replace the harness. If +12 is present, check pin 7 at the panel and control box for ground. Then replace the touch panel.</p>	 <p style="text-align: center;"><b>REFER TO MP85.3024</b></p>  <p style="text-align: center;"><b>REFER TO MP85.3024</b></p>  <p style="text-align: center;"><b>REFER TO MP85.3017</b></p>

# REPAIR STEPS

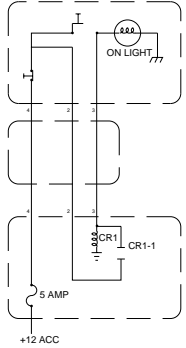
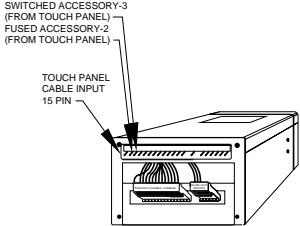
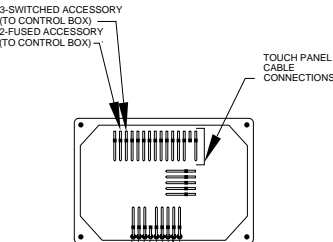

PROBLEM	SOLUTION	DIAGRAMS
<p><b>Part 3 continued</b></p> <p>b. The red POWER ON light comes on but goes out when the "ON" button is released.</p>	<p>While pushing the "ON" (I) button, check pins 2 and 3 of the TOUCH PANEL CABLE CONNECTIONS at the touch panel. If +12 is not present on both pins, replace the touch panel. If +12 is present on both pins, check pins 2 and 3 of the TOUCH PANEL CABLE INPUT at the control box while pushing the "ON" button. If either pins 2 or 3 do not have +12, replace the touch panel cable. If both pins 2 and 3 at the control box have +12, replace the control box.</p>	
		<p><b>REFER TO MP85.3031</b></p> 
		<p><b>REFER TO MP85.3024</b></p> 
		<p><b>REFER TO MP85.3017</b></p>

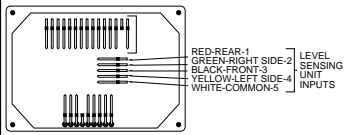
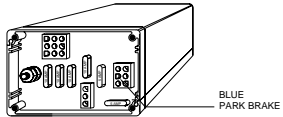
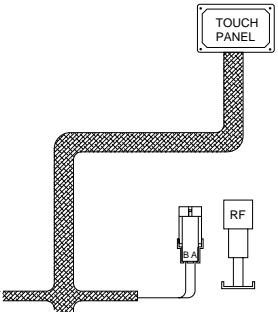
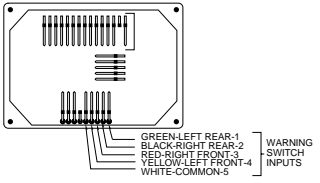
# REPAIR STEPS

PROBLEM	SOLUTION	DIAGRAMS
<p><b>Part 3 continued</b></p> <p>c. More than one yellow light is on or opposing yellow lights are on.</p>	<p>Unplug the level sensing unit inputs from the touch panel. If yellow lights remain on, replace the touch panel. If the yellow lights go out, ground pins 1 thru 4 of the LEVEL SENSING UNIT INPUTS. If the wrong light or more than one yellow light comes on, replace the touch panel. If the lights are OK, replace the sensing unit.</p>	 <p style="font-size: small;">RED-REAR-1 GREEN-RIGHT SIDE-2 BLACK-FRONT-3 YELLOW-LEFT SIDE-4 WHITE-COMMON-5</p> <p style="font-size: small;">LEVEL SENSING UNIT INPUTS</p> <p style="text-align: center; font-weight: bold;">REFER TO MP85.3017</p>
<p>d. The "NOT IN PARK/BRAKE" light is on.</p>	<p>The control box will accept a ground signal from the park brake switch. With the park brake set, make sure that the (BLUE) 9300 park brake wire at the control box has the correct signal. If a signal is not present, repair the (BLUE) 9300 wire or the park brake switch. If the signal is present, replace the control box.</p> <p><b>NOTE:</b> Most vehicles will have a ground from the park brake switch. If the park brake switch supplies a +12 signal, a special control box is needed. Check that the correct control box is being used.</p>	 <p style="font-size: small;">BLUE PARK BRAKE</p> <p style="text-align: center; font-weight: bold;">REFER TO MP85.3024</p>
<p>e. A red "WARNING" light is on. (The jacks are completely retracted.)</p>	<p>Unplug the jack warning switch that corresponds to the red warning light that is on. If the light goes out, replace the warning switch.</p> <p>If the light does not go out, unplug the warning switch inputs from the touch panel. If the light goes out, the problem is in the warning switch harness. If the light remains on, replace the touch panel.</p>	 <p style="font-size: small;">TOUCH PANEL</p> <p style="font-size: small;">H B.A RF</p> <p style="text-align: center; font-weight: bold;">REFER TO MP85.3016</p>  <p style="font-size: small;">GREEN-LEFT REAR-1 BLACK-RIGHT REAR-2 RED-RIGHT FRONT-3 YELLOW-LEFT FRONT-4 WHITE-COMMON-5</p> <p style="font-size: small;">WARNING SWITCH INPUTS</p> <p style="text-align: center; font-weight: bold;">REFER TO MP85.3017</p>
<p>f. The pump runs when the touch panel is turned on.</p>	<p>Push the "OFF" button. If the pump does not stop, see Part 1b of this section. If the pump stops, replace the touch panel.</p>	

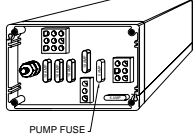
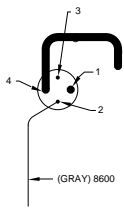
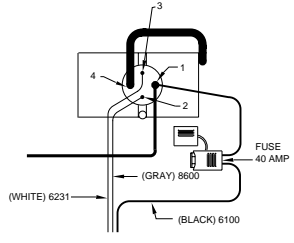
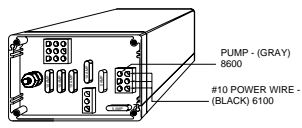
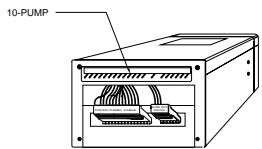
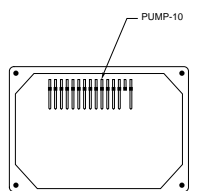

# REPAIR STEPS

PROBLEM	SOLUTION	DIAGRAMS
<p><b>Part 4</b>  <b>While pushing an EXTEND button: (up arrow)</b></p> <p>a. The pump does not come on.</p>	<p>Check the pump fuse.</p> <p><b>If the pump fuse is blown</b>, the (GRAY) 8600 wire in the pump/manifold harness is shorted to ground or the pump relay is bad. Remove the (GRAY) 8600 wire from Terminal 2 at the pump relay. Replace the pump fuse and retry. If the fuse blows, the problem is the (GRAY) 8600 wire. If the fuse does not blow, replace the pump relay.</p> <p><b>If the pump fuse is not blown</b>, check Terminal 1 of the pump relay for +12 volts. If voltage is not present, the problem is the connection, the battery cable or the battery is the problem.</p> <p>The (WHITE) 6231 wire on Terminal 3 supplies the ground for the pump relay. Check that Terminal 3 has a good ground. If Terminal 1 has +12, check Terminal 2 (GRAY) 8600 wire and Terminal 4 (pump motor cable) while pushing an EXTEND button. If +12 is present on Terminal 2 but not on Terminal 4, replace the pump relay. If +12 is present on Terminals 2 and 4, check the cable connections and the pump motor ground. If these are OK, replace the pump.</p>	 <p><b>REFER TO MP85.3024</b></p> 
	<p><b>NOTE: All harnesses and cables can be left plugged in for these test.</b></p>	<p><b>REFER TO MP85.3033</b></p> 
	<p><b>If Terminal 2 (GRAY) 8600 wire does not have +12 volts while pushing an EXTEND button</b>, check the pump output at the control box (6 pin UML connector). If +12 is present, the problem is the (GRAY) 8600 wire in the pump/manifold harness. If +12 is not present at the output, check for +12 volts at the 40 amp fuse in the (BLACK) 6100 wire at the pump relay. The (BLACK) 6100 wire has to be connected to the battery side of the pump relay. <b>If the 40 amp fuse is blown</b>, unplug the 6 pin UML connector from the control box. Replace the 40 amp fuse. If the fuse blows, the problem is the #10 (BLACK) wire shorted to ground. If the fuse does not blow, plug the connector back into the box and retry. If the fuse blows, replace the control box. If not, continue the test. <b>If the 40 amp fuse is not blown</b>, check pin 10 (PUMP) of the TOUCH PANEL CABLE INPUT of the control box. If +12 is present while pushing an EXTEND button, replace the control box.</p>	<p><b>REFER TO MP85.3033</b></p> 
	<p><b>If pin 10 (PUMP) at the control box does not have +12</b>, check pin 10 (PUMP) at the touch panel. If +12 is present at pin 10 of the touch panel, while pushing an EXTEND button, replace the TOUCH PANEL CABLE ASSEMBLY.</p>	<p><b>REFER TO MP85.3024</b></p> 
	<p>If pin 10 (PUMP) at the touch panel does not have +12 power while pushing an EXTEND button, replace the touch panel.</p>	<p><b>REFER TO MP85.3024</b></p> 
		<p><b>REFER TO MP85.3017</b></p>
		
		<p><b>REFER TO MP85.3016</b></p>

# REPAIR STEPS

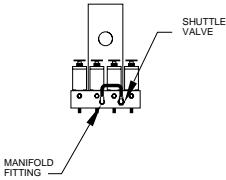
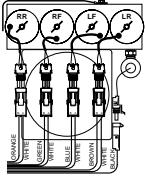
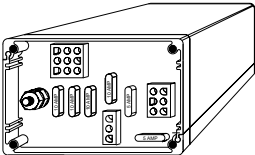
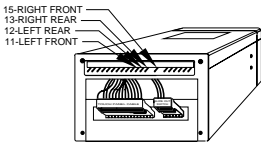
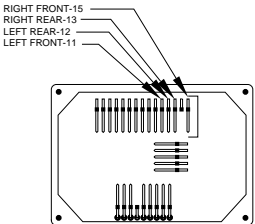
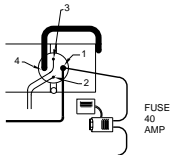
PROBLEM	SOLUTION	DIAGRAMS
<p><b>Part 4 continued</b></p> <p>b. The pump runs under no load and no jacks are moving.</p>	<p>If the vehicle is equipped with a HWH room extension, check that that the room retract solenoid valve is not open.</p> <p>Remove the tube between the shuttle valve and the manifold fitting. Connect a pressure gauge to the manifold fitting.</p> <p><b>NOTE: The pressure gauge needs to have at least a 4000 psi capacity.</b></p> <p>Check the pressure while the pump is running. There should be approximately 3500 psi. If the pressure is ok, replace the shuttle valve. If the pressure is not ok, replace the pump.</p>	 <p style="text-align: center;"><b>REFER TO MP65.0</b></p>
<p>c. The pump runs and 1 or 2 jacks will not go vertical. (extend)</p> <p><b>NOTE: The EXTEND button corresponding to the malfunctioning jack must be pushed while performing these tests.</b></p>	<p>Unplug the solenoid valve for the jack that will not extend. Check between pin A and B of the manifold harness plug. If +12 is present, check for fluid flow and pressure to the jack. If there is pressure to the jack, the problem is the jack or for a kick-down jack, the problem is the actuator. Check the roller bearing or actuator cable and horizontal stops before changing the actuator. If there is no pressure from the manifold, replace the solenoid valve. If +12 is not present, check between pin B and ground. If +12 is present, the white wire in the plug is not supplying a ground and needs to be repaired.</p> <p><b>If +12 is not present at the manifold harness plug</b>, check the proper solenoid valve output at 9 pin UML connector at the control box. If +12 is present, the problem is the PUMP/MANIFOLD HARNESS. If +12 is not present at the UML connector, check the fuse for that valve. If the fuse is blown, the harness or the solenoid valve is shorted. If the fuse is OK, check the appropriate pin in the touch panel cable at the other end of the box. If +12 is present, replace the control box.</p> <p><b>If +12 is not present at control box</b>, check the appropriate pin on the touch panel. If +12 is present, the TOUCH PANEL CABLE ASSEMBLY is bad. If +12 is not present, replace the touch panel.</p> <p><b>IMPORTANT: The TOUCH PANEL CABLE ASSEMBLY must remain plugged into the control box and the touch panel when testing the system.</b></p>	 <p style="text-align: center;"><b>REFER TO MP85.3033</b></p>  <p style="text-align: center;"><b>REFER TO MP85.3024</b></p>  <p style="text-align: center;"><b>REFER TO MP85.3024</b></p>  <p style="text-align: center;"><b>REFER TO MP85.3017</b></p>
<p>d. The pump runs under load, no jacks will extend.</p> <p style="text-align: center;">OR</p> <p>The system "chatters" as the jacks extend.</p>	<p>Check voltage on Terminal 1 of the pump relay while the pump is running. If the voltage is below 9 volts, there is a connection, cable, ground or battery problem.</p> <p style="text-align: center;"><b>(Continued on next page.)</b></p>	 <p style="text-align: center;"><b>REFER TO MP85.3033</b></p>

# REPAIR STEPS

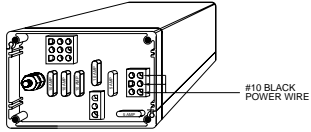
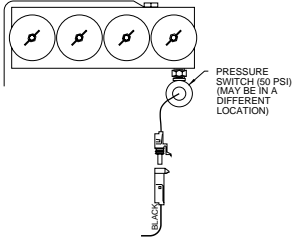
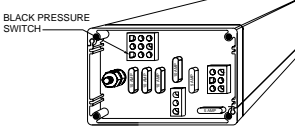
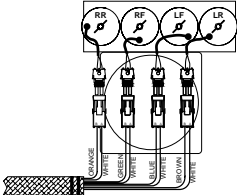
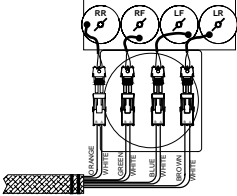
PROBLEM	SOLUTION	DIAGRAMS
<p><b>Part 4d continued</b></p>	<p><b>The voltage to the pump and the 40 amp fuse are OK.</b> Unplug the manifold pressure switch. Ground the (BLACK) 8100 pressure switch wire from the harness and retry. If the jacks will now extend, remove the pressure switch. Briefly push an EXTEND button. If fluid squirts from the pressure switch fitting, replace the pressure switch. If not, replace the shuttle valve.</p> <p><b>The jacks will not extend while grounding the pressure switch wires.</b> Leave the pressure switch wire at the manifold grounded. Check the (BLACK) 8100 pressure switch wire in the 9 pin UML at the control box. If ground is present, replace the control box. If ground is not present, the problem is the pressure switch wire in the harness.</p> <p><b>The system chatters as the jacks extend.</b></p> <p>Check the manifold ground wire.</p> <p>The manifold pressure switch may need to be adjusted. Try turning the adjustment counter clockwise 1/2 turn at a time up to one full turn. If this doesn't fix it, try turning the adjustment clockwise two turns, 1/2 a turn at a time. If this does not fix the problem, replace the switch. See MP85.5105 for adjustment procedure.</p>	 <p style="text-align: right; margin-right: 10px;">#10 BLACK POWER WIRE</p> <p style="text-align: center;"><b>REFER TO MP85.3024</b></p>  <p style="text-align: right; margin-right: 10px;">PRESSURE SWITCH (50 PSI) (MAY BE IN A DIFFERENT LOCATION)</p> <p style="text-align: center;"><b>REFER TO MP85.3033</b></p>  <p style="text-align: left; margin-left: 10px;">BLACK PRESSURE SWITCH</p> <p style="text-align: center;"><b>REFER TO MP85.3024</b></p>
<p><b>PROBLEMS 4e and 4f are for kick-down jacks only.</b></p> <p>4e. A jack extends in the horizontal position.</p>	<p>Check that the jack will pivot freely. Check that rollers, stops and/or cables are in place and working properly. If this is ok, replace the actuator.</p>	<p style="text-align: center;"><b>REFER TO MP65.3030</b></p> <p style="text-align: center;"><b>REFER TO MP65.3035</b></p> <p style="text-align: center;"><b>REFER TO MP65.3040</b></p>
<p>f. A jack retracts to the horizontal position after the EXTEND button is released. (The pump should be off)</p>	<p>Push and hold an EXTEND button that controls the malfunctioning jack. Hold the button until the jack reaches the ground and lifts the coach approximately 1 inch. Release the button. If the jack remains extended, replace the actuator. If the jack retracts, check the harness plug for the corresponding solenoid valve for +12 volts. The EXTEND button should NOT be pushed at this time. If +12 is present, replace the control box or touch panel. If +12 is not present, replace the solenoid valve.</p> <p>Make sure the system is not in the STORE mode.</p>	 <p style="text-align: center;"><b>REFER TO MP85.3033</b></p>
<p><b>For straight-acting jacks.</b></p> <p>g. A jack retracts after the EXTEND button is released. (The pump should be off.)</p>	<p>Check the harness plug for the corresponding solenoid valve for +12 volts. The EXTEND button should NOT be pushed at this time. If +12 is present, replace the control box or touch panel. If +12 is not present, replace the solenoid valve.</p> <p>Make sure the system is not in the STORE mode.</p>	 <p style="text-align: center;"><b>REFER TO MP85.3033</b></p>

# REPAIR STEPS

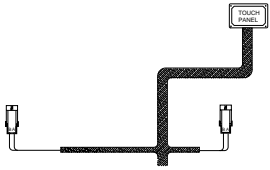
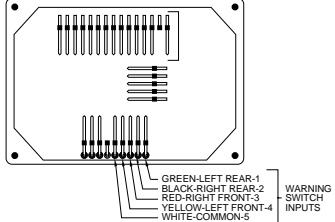
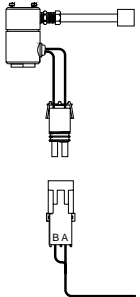
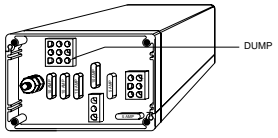
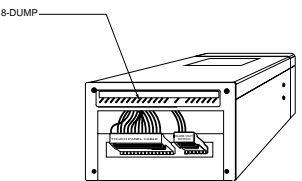
PROBLEM	SOLUTION	DIAGRAMS
<p><b>Part 4 continued</b></p> <p>h. A red WARNING light will not come on when the jack is vertical or extended.</p>	<p>Unplug the jack warning switch. Ground the (colored) black wire (B-pin) of the warning switch harness plug. If the red light comes on, replace the warning switch.</p> <p>If the light does not come on, use a test light to ground the pin for that warning switch on the touch panel. If the light comes on, the problem is the wire. If the light does not come on, replace the touch panel.</p>	 <p style="text-align: center;"><b>REFER TO MP85.3016</b></p>  <p style="text-align: center;"><b>REFER TO MP85.3017</b></p>
<p>i. The pump continues to run after releasing an EXTEND button.</p>	<p>Push the "OFF" button. If the pump turns off, replace the touch panel. If the pump continues to run, release the park brake. If the pump turns off, replace the control box. If the pump continues to run, replace the pump relay.</p> <p><b>Important: DO NOT allow the pump to run more than 3 minutes. This will damage the pump motor.</b></p>	
<p><b>Part 5</b></p> <p><b>While pushing the "DUMP" button:</b></p> <p>a. Air will not exhaust from an air dump valve.</p>	<p><b>NOTE: There should be one air dump valve for each height control valve.</b></p> <p>Check for +12 between the A and B pin of the air dump harness plug at the air dump valve. If +12 is present, replace the air dump valve. If +12 is not present, the problem is in the harness.</p>	 <p style="text-align: center;"><b>REFER TO MP75.2</b></p> <p style="text-align: center;"><b>REFER TO MP85.3016</b></p>
<p>b. Air will not exhaust from any air dump valve.</p>	<p>While pushing the "DUMP" button, check for +12 on the DUMP pin in the 9 pin UML at the control box. If +12 is present, refer to Part 5a and check each air dump valve. If +12 is not present, check for +12 on pin 8 (DUMP) on the other end of the control box. If +12 is present, replace the control box.</p>	 <p style="text-align: center;"><b>REFER TO MP85.3024</b></p>  <p style="text-align: center;"><b>REFER TO MP85.3024</b></p>

# REPAIR STEPS

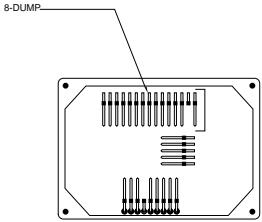
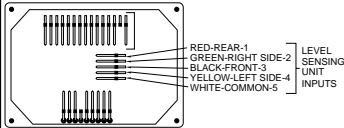
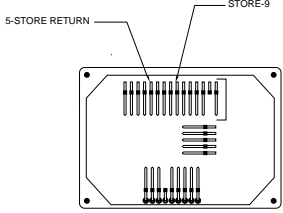
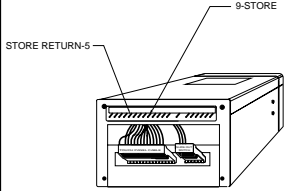
PROBLEM	SOLUTION	DIAGRAMS
<p><b>Part 5b continued</b></p>	<p><b>+12 is not present at the control box.</b> Check for +12 on pin 8 (DUMP) at the touch panel. If +12 is present, the problem is on the touch panel cable assembly. If +12 is not present at the touch panel, replace the touch panel.</p> <p><b>NOTE: The touch panel cable must remain plugged in for these tests.</b></p>	 <p style="text-align: center;"><b>REFER TO MP85.3017</b></p>
<p><b>Part 6</b></p> <p><b>a. More than one yellow light comes on. (Not opposing lights)</b></p>	<p>Replace the touch panel.</p>	
<p><b>b. Opposing lights or no yellow lights come on.</b></p>	<p>Unplug the sensing unit from the touch panel. Use a test light to ground pins 1 thru 4 of the level sensing unit inputs. If more than one light or no lights come on, replace the touch panel. If the lights work properly, check pin 5 for ground. Pin 5 supplies the ground for the sensing unit. If ground is present, replace the sensing unit. If ground is not present, replace the touch panel.</p> <p><b>NOTE: The touch panel cable must remain plugged in.</b></p>	 <p style="text-align: center;"><b>REFER TO MP85.3017</b></p>
<p><b>Part 7</b></p> <p><b>After pushing the "STORE" button:</b></p> <p>a. The red STORE light will not come on.</p>	<p>Replace the touch panel.</p>	
<p>b. The red STORE light will come on but will not remain on.</p>	<p>While pushing the "STORE" button, check pins 5 and 9 at the touch panel. If +12 is not present, replace the touch panel. If +12 is present, check pins 5 and 9 at the control box. If +12 is not present, replace the touch panel cable. If +12 is present, replace the control box.</p> <p><b>NOTE: The touch panel cable must remain plugged into the touch panel and control box during this test.</b></p>	 <p style="text-align: center;"><b>REFER TO MP85.3017</b></p>  <p style="text-align: center;"><b>REFER TO MP85.3024</b></p>

# REPAIR STEPS

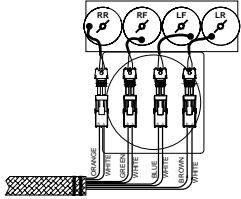
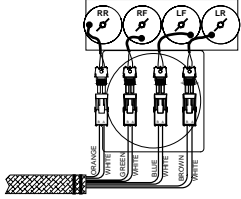
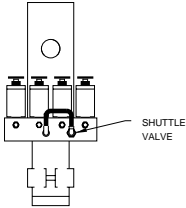
PROBLEM	SOLUTION	DIAGRAMS
<p><b>Part 7 continued</b></p> <p>c. The red STORE light is on but a jack will not retract.</p>	<p>While the STORE light is on, unplug the solenoid valve for the jack that will not retract. Check for +12 between the A and B pin in the harness plug.</p> <p><b>If +12 is present</b>, loosen the hose for that solenoid valve. If the jack does not start to retract, retighten the hose. Loosen the hose at the jack. If the jack starts to retract, the hose is probably kinked somewhere. If the jack does not retract, replace the cylinder if it is a straight-acting jack. If it is a kick-down jack, loosen the actuator or the actuator tube. If the jack starts to retract, replace the actuator. If not, replace the jack.</p> <p><b>If +12 is not present at the harness plug, plug the solenoid valve back in.</b> Push the "OFF" button on the touch panel. Turn the system back on and try the EXTEND button for that jack. If the jack will extend, replace the touch panel. If the jack will not extend, go thru Part 4 of Section 1, TROUBLE SHOOTING STEPS.</p>	 <p><b>REFER TO MP85.3033</b></p> <p><b>REFER TO MP65.3030</b></p> <p><b>REFER TO MP65.3035</b></p> <p><b>REFER TO MP65.3040</b></p>
<p><b>FOR KICK-DOWN JACKS ONLY.</b></p> <p>d. The foot of the jack retracts, but the jack will not return to the horizontal position.</p>	<p>Check that actuator cables or rollers are ok. If they are ok, replace the actuator.</p>	<p><b>REFER TO MP65.3030</b></p> <p><b>REFER TO MP65.3035</b></p> <p><b>REFER TO MP65.3040</b></p>
<p>e. All jacks remain extended and will not retract. The STORE light is on.</p>	<p>Check for +12 at any plug for any solenoid valve. If +12 is not present, push an EXTEND button. If the jacks extend replace the Touch Panel. If the jacks do not extend, go back to Part 4 of Section 1, TROUBLE SHOOTING STEPS.</p> <p>If +12 is present at the solenoid valve plugs, replace the shuttle valve.</p>	  <p><b>REFER TO MP85.3033</b></p> <p><b>REFER TO MP65.0</b></p>

# REPAIR STEPS

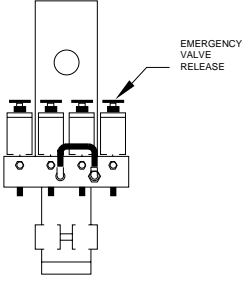
PROBLEM	SOLUTION	DIAGRAMS
<p><b>Part 7 continued</b></p> <p>f. A red WARNING light stays on when the jacks are completely retracted.</p>	<p>Refer to PROBLEM Part 3e of the REPAIR STEPS.</p>	
<p>g. The system will not turn off automatically (approximately 2 minutes) after all the red WARNING lights are out.</p>	<p>Check the +12 supply for the MASTER WARNING light and BUZZER. If the +12 supply is from the Ignition switch, make sure the proper harness with diode is used. If the harness does not have a diode, the box may not turn off. If the diode is present or the +12 comes from the control box, replace the control box.</p>	<p><b>REFER TO MP85.3053</b></p>
<p><b>Part 8</b></p> <p><b>Jacks will NOT retract using the "T" handle release on the solenoid valves.</b></p>	<p>If none of the jacks will retract using the "T" handles, the shuttle valve is bad.</p> <p>If only one jack will not retract using the "T" handles, loosen the hydraulic line for that jack. If the jack retracts, replace the solenoid valve. If the jack does not retract, the hose could be kinked or the actuator or jack is bad.</p> <p>If no jacks will retract, make sure all of the T-Handles are closed and the Leveling Touch Panel is off. Remove then reassemble any one check valve cap.</p> <p>The jacks should now store using the "STORE" button. If the jacks still will not store, contact HWH Corporation Customer Service for assistance.</p>	<div style="text-align: center;">  <p style="font-size: small; margin-top: 5px;">EMERGENCY VALVE RELEASE</p> </div> <p style="text-align: center; margin-top: 10px;"><b>REFER TO MP65.0</b></p>

# HYDRAULIC LINE CONNECTION DIAGRAM LEVELING SYSTEM



FRONT

**NOTE:** BEFORE OPERATING VALVE RELEASE "T" HANDLES, READ AND UNDERSTAND PROCEDURE FOR MANUAL JACK RETRACTION IN OPERATOR'S INSTRUCTIONS.

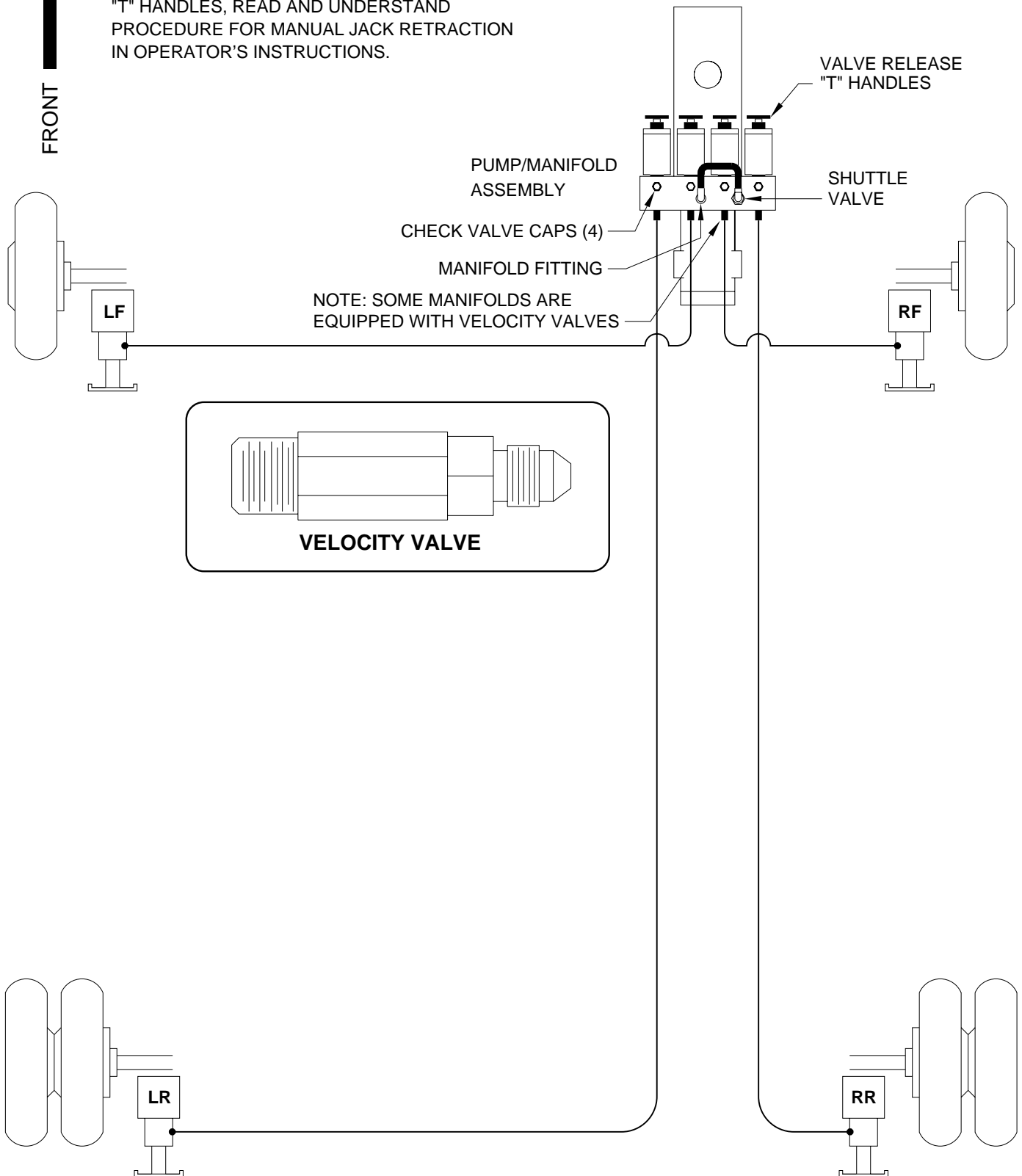



# HYDRAULIC SCHEMATIC 310 SERIES LEVELING SYSTEM WITH STRAIGHT-ACTING JACKS

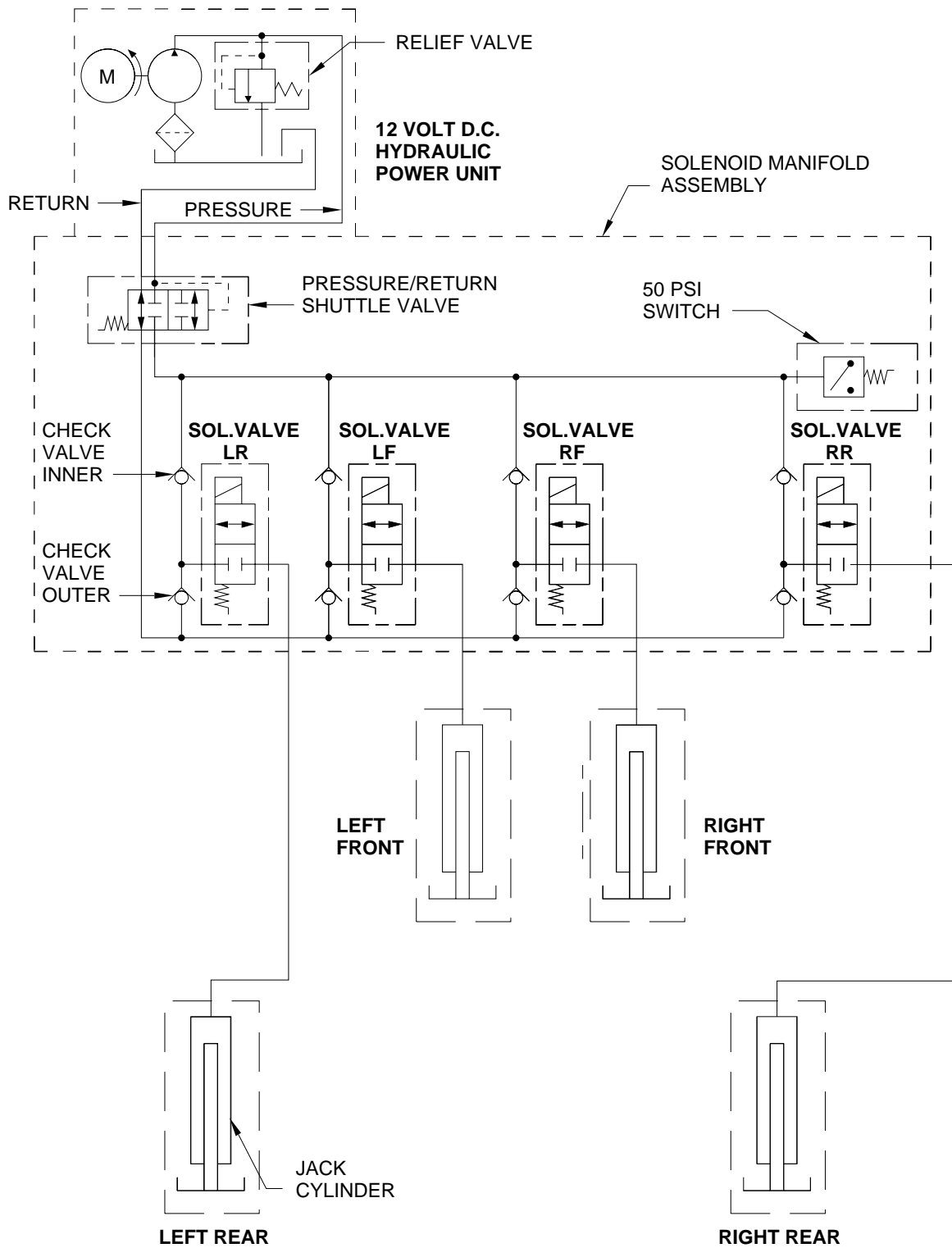

# HYDRAULIC SCHEMATIC

## 310 SERIES TOUCH PANEL-CONTROLLED LEVELING SYSTEM WITH KICK-DOWN JACKS

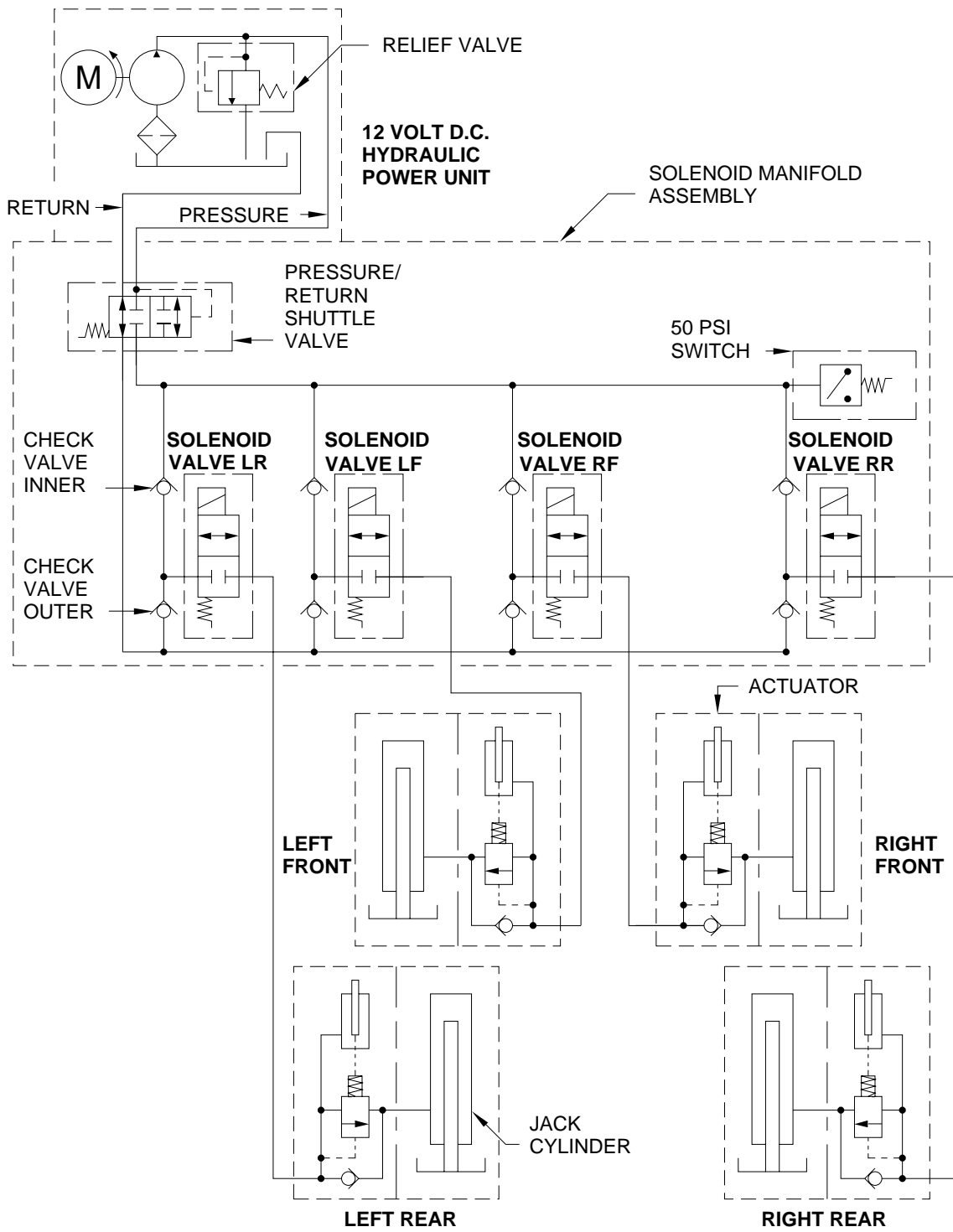

---

**6000# KICK-DOWN JACK FOR ALL MANUAL LEVELING SYSTEMS  
WITH 2-WIRE WARNING SWITCH**

---

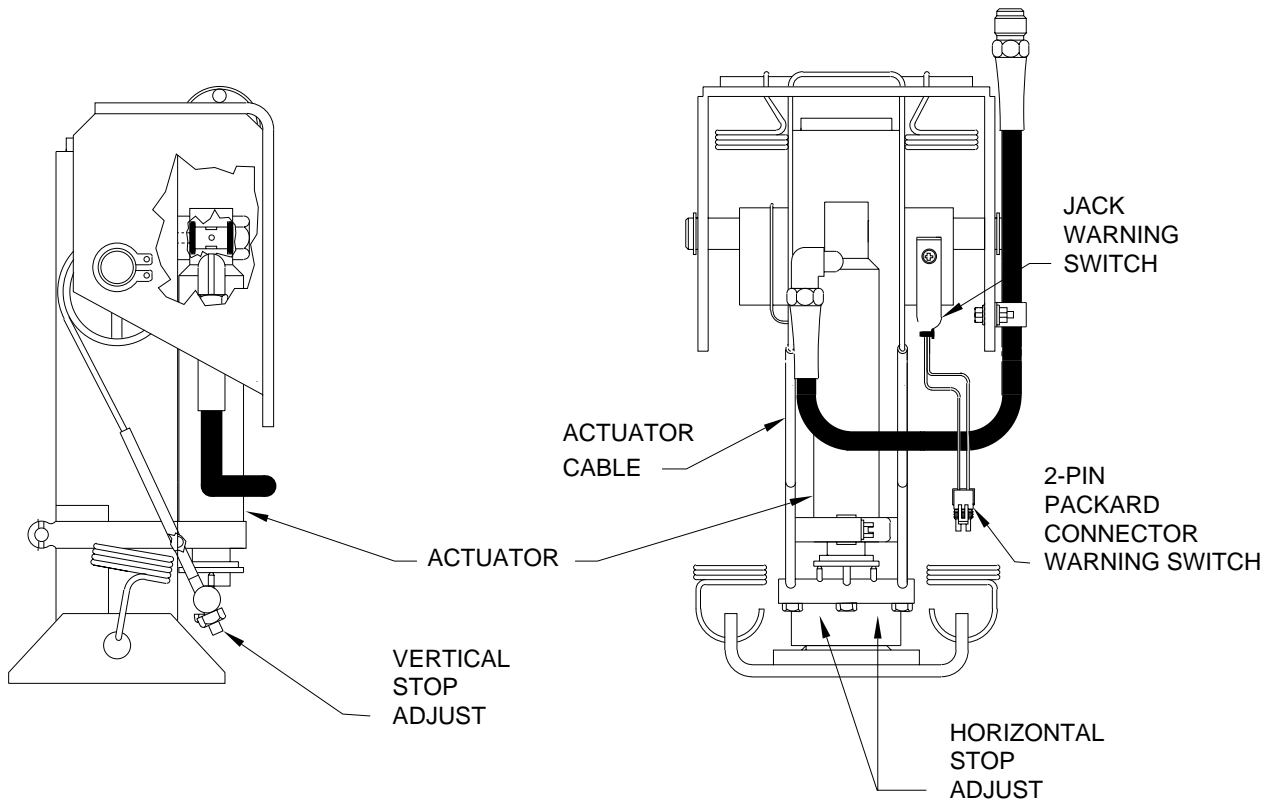

---

# 9000# KICK-DOWN JACK FOR ALL MANUAL LEVELING SYSTEMS WITH 2-WIRE WARNING SWITCH

---

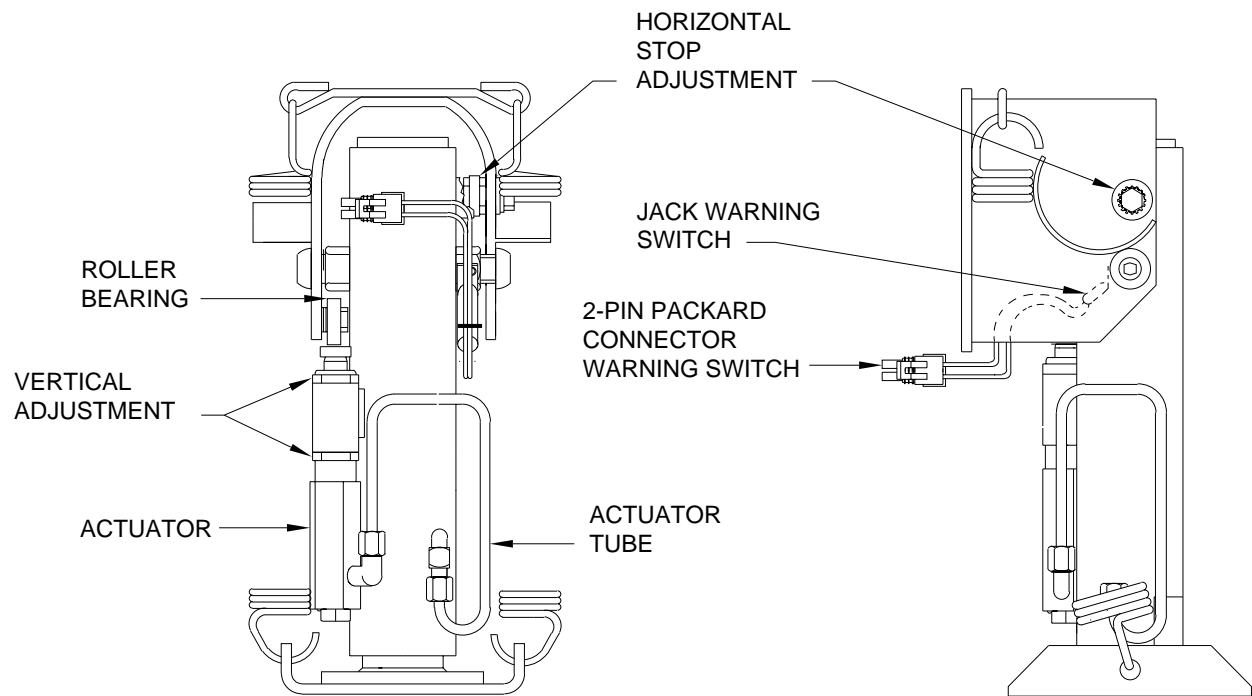

**16000# KICK-DOWN JACK FOR ALL MANUAL LEVELING SYSTEMS  
WITH 2-WIRE WARNING SWITCH**

2-PIN PACKARD  
CONNECTOR  
WARNING SWITCH

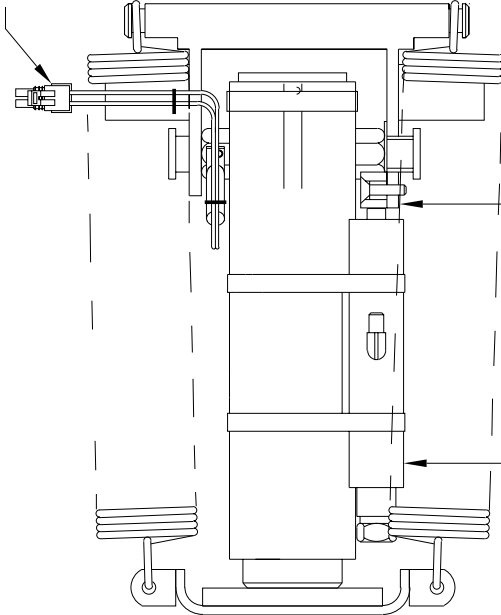

ROLLER  
KIT

ACTUATOR

JACK  
WARNING  
SWITCH

HORIZONTAL  
STOP  
ADJUST

VERTICAL  
STOP  
ADJUST

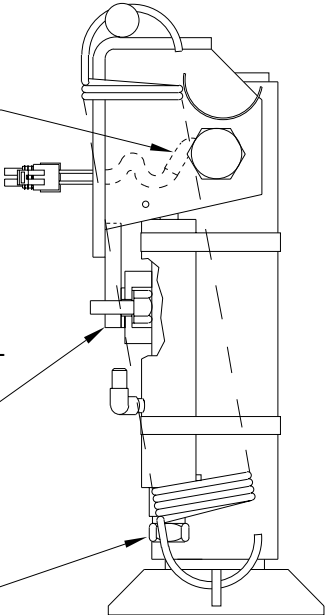

---

**STRAIGHT-ACTING JACK FOR ALL MANUAL LEVELING SYSTEMS  
WITH 2-WIRE WARNING SWITCH  
RETURN SPRINGS SIDE / SIDE**

---

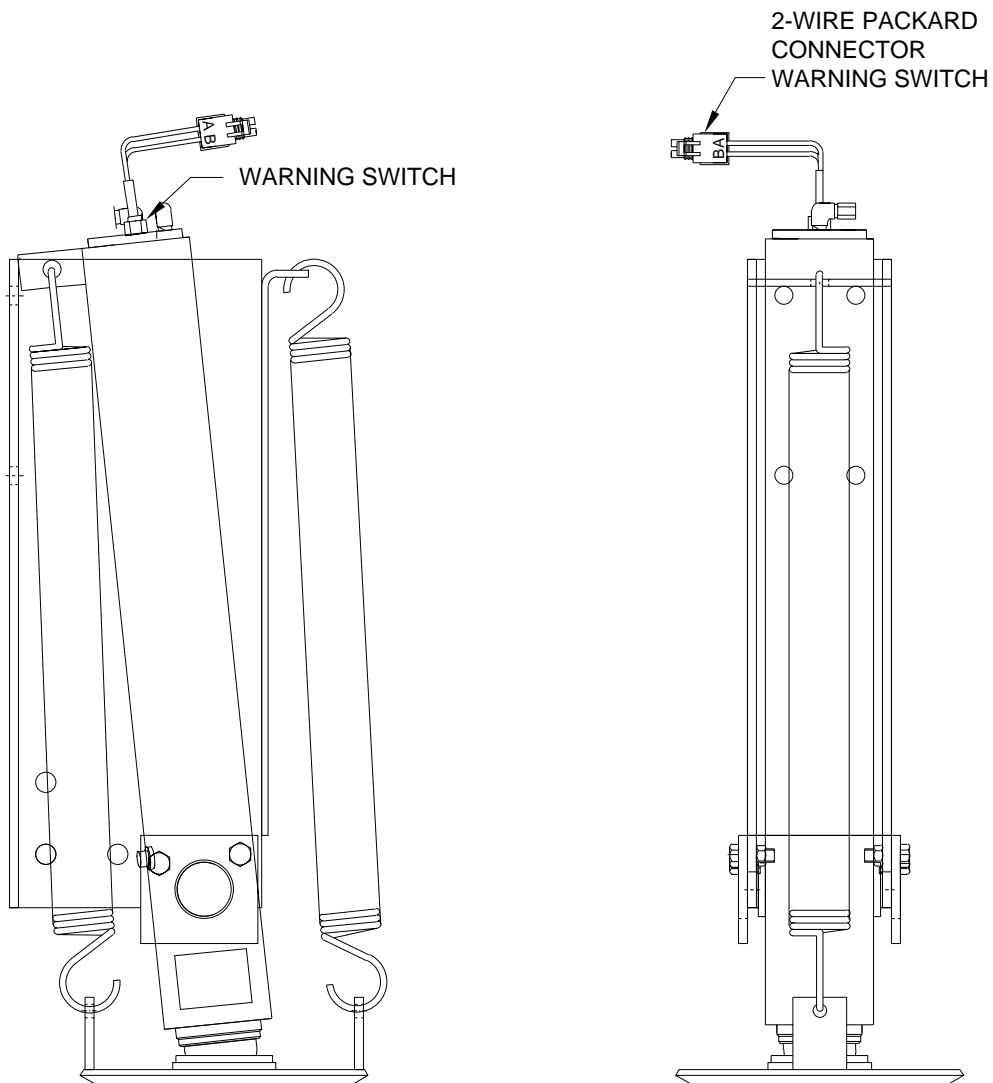
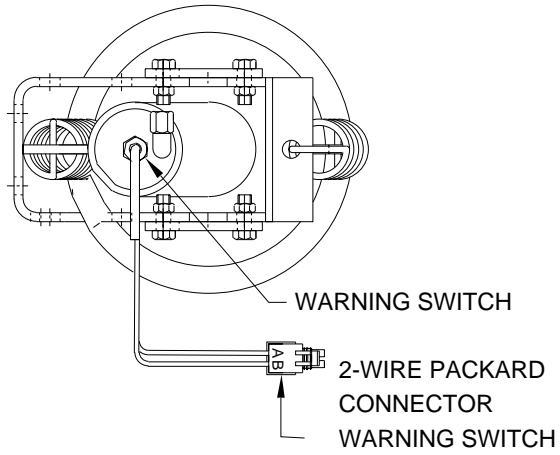

# AIR LINE CONNECTION DIAGRAM

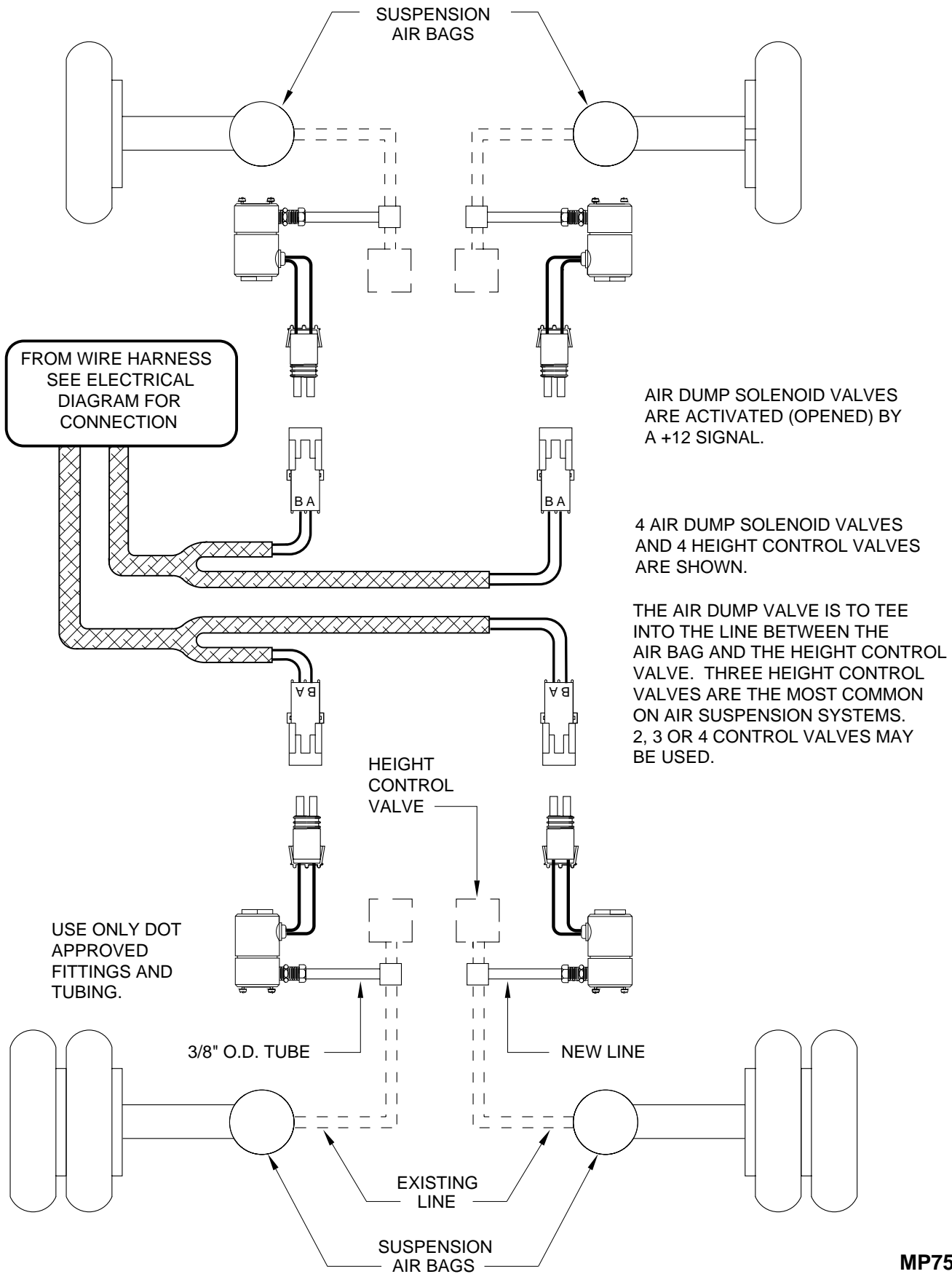

# 310 LEVELING SYSTEM ELECTRICAL CONNECTION DIAGRAM WITH SUSPENSION AIR DUMP

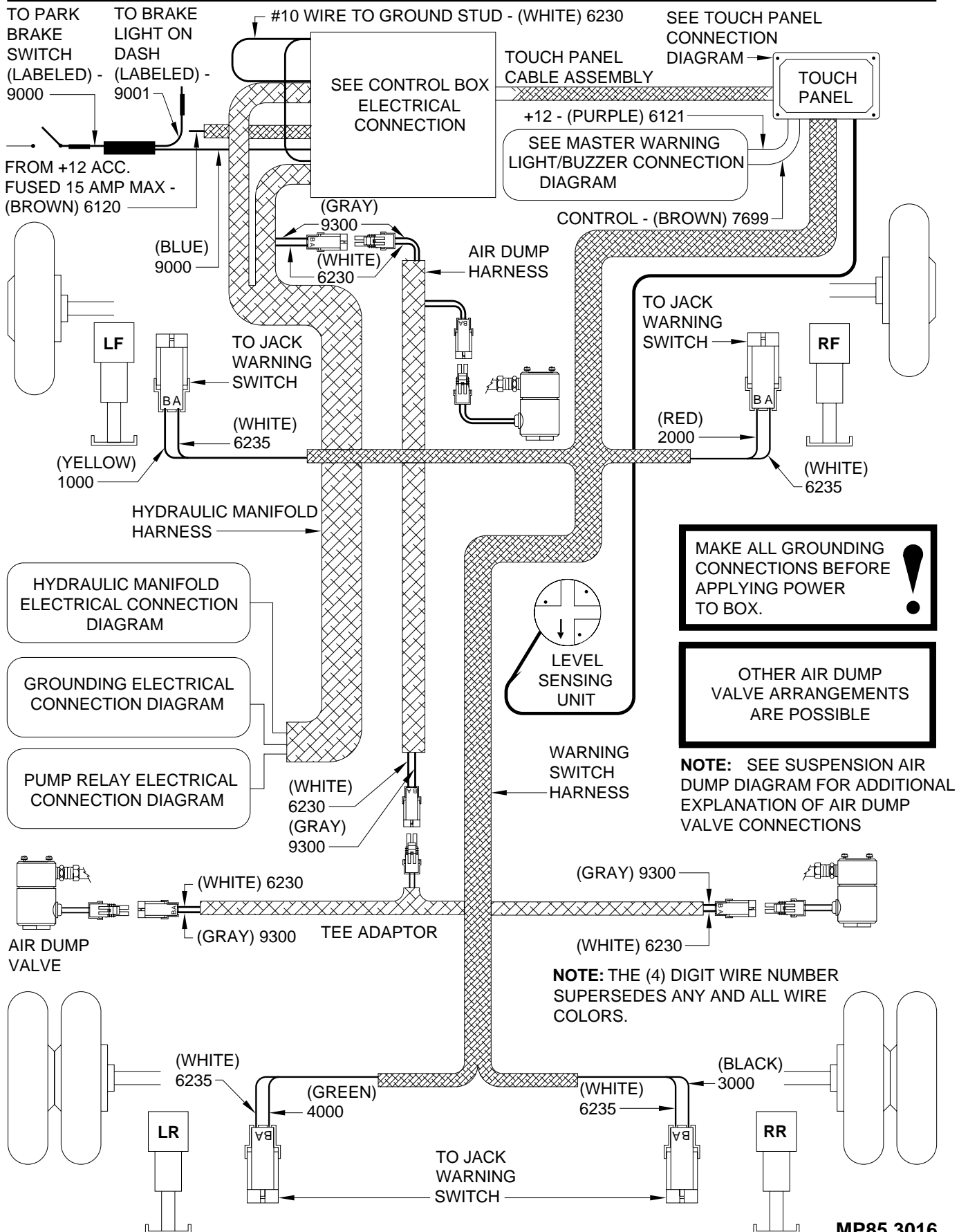



# CONNECTION DIAGRAM

## 310 SERIES LEVELING SYSTEM TOUCH PANEL

### WITH SUSPENSION AIR DUMP

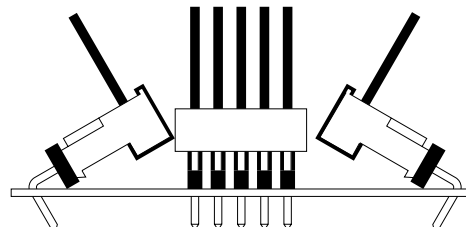
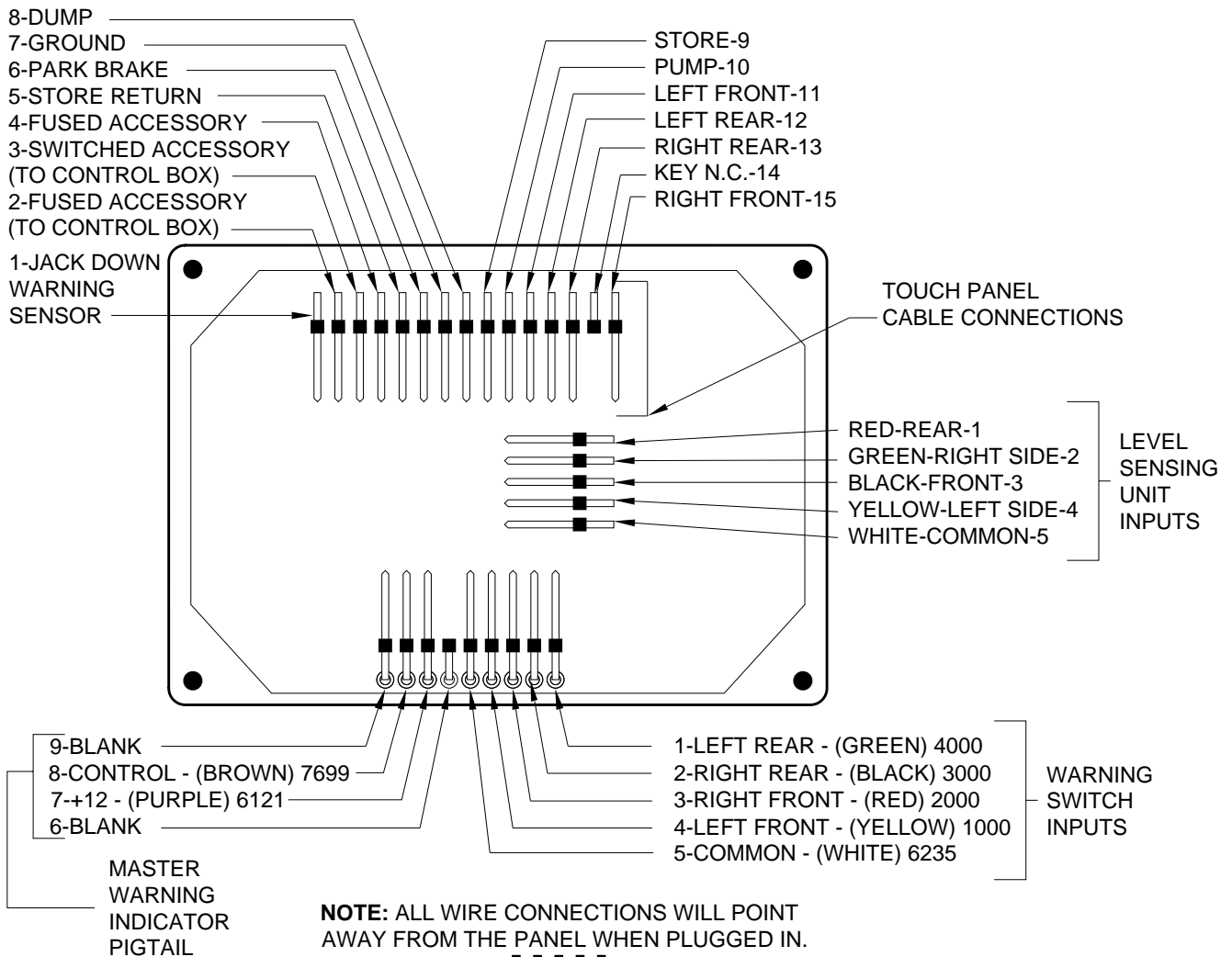
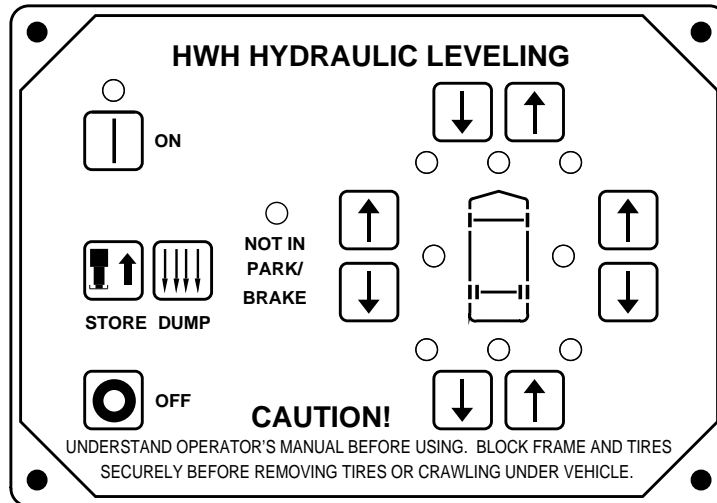

**NOTE:** THE (4) DIGIT WIRE NUMBER SUPERSEDES ANY AND ALL WIRE COLORS.

# ELECTRICAL CONNECTION DIAGRAM CONTROL BOX 310 SERIES LEVELING SYSTEM WITH SUSPENSION AIR DUMP

**NOTE:** THE (4) DIGIT WIRE NUMBER SUPERSEDES ANY AND ALL WIRE COLORS.

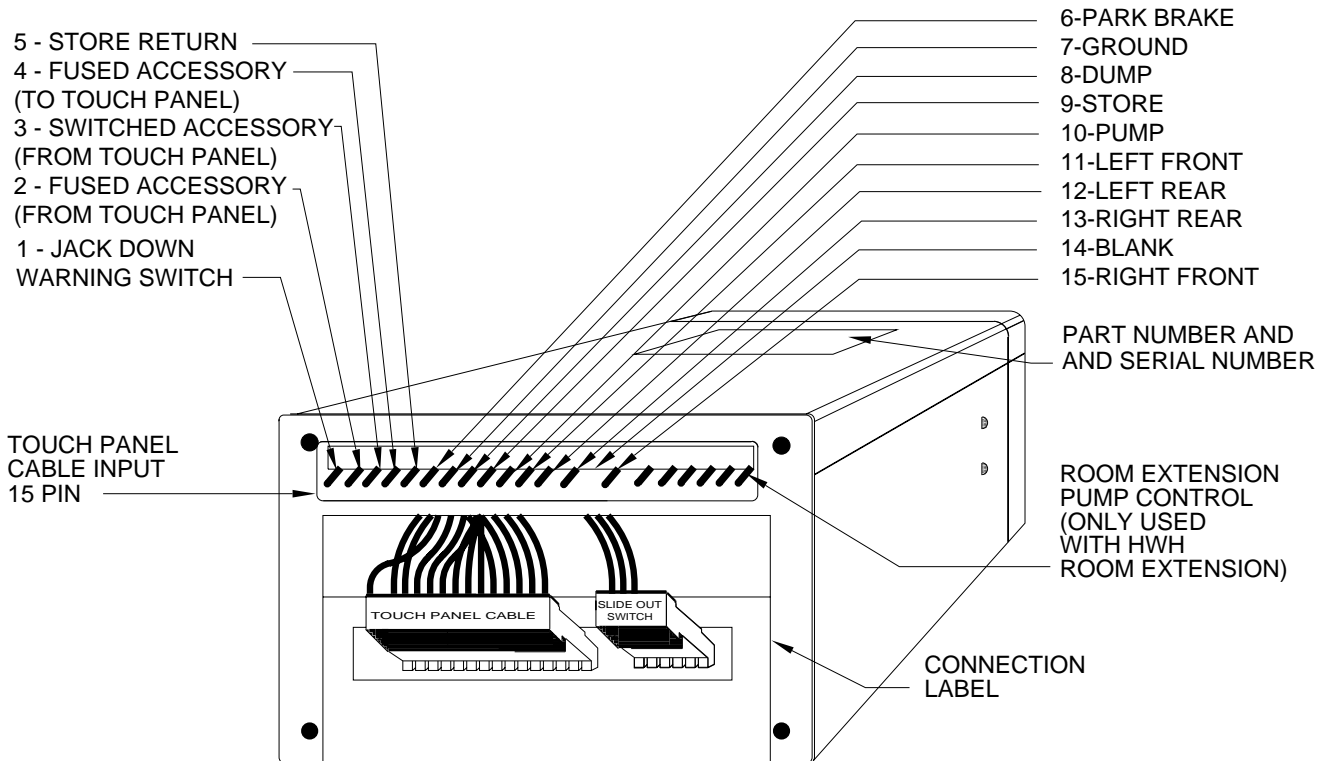
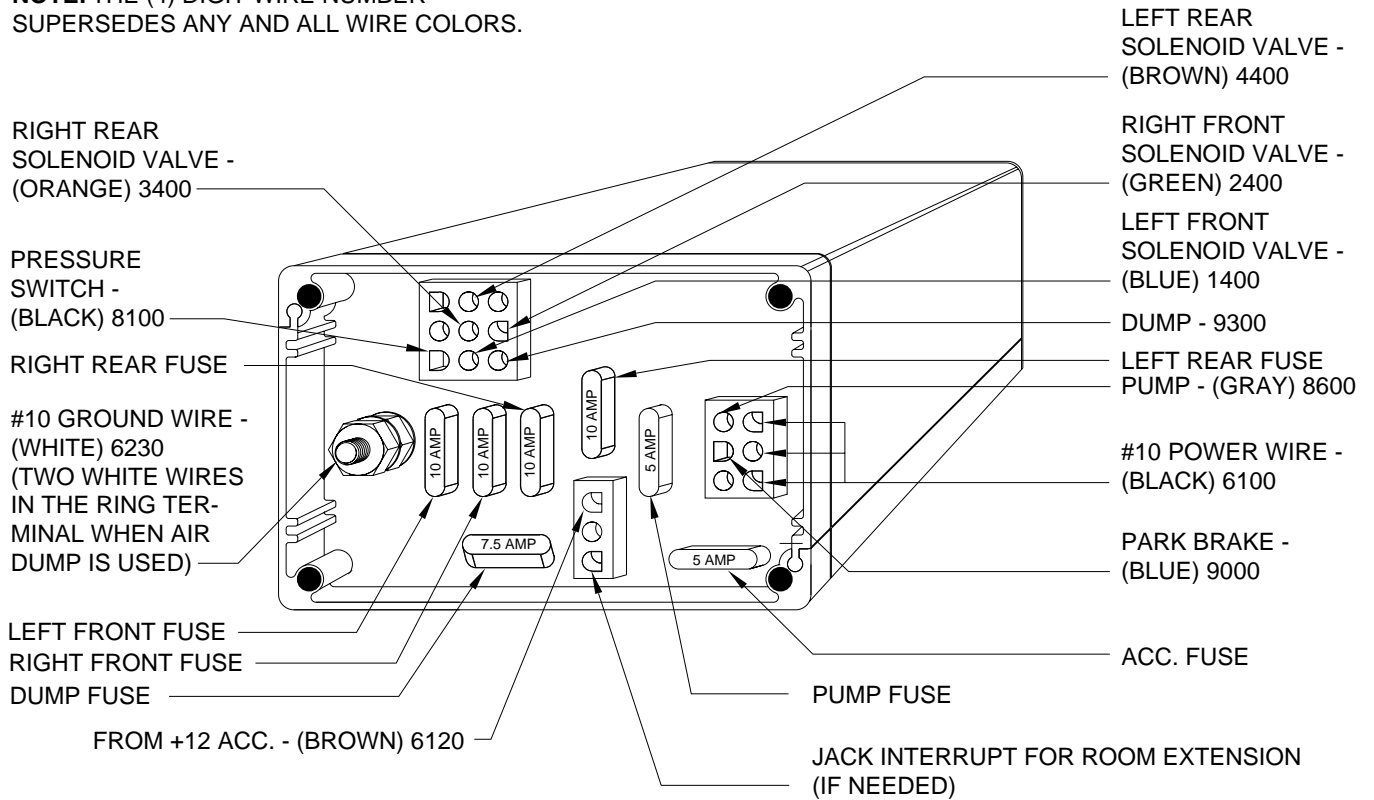

**310 LEVELING SYSTEM  
ELECTRICAL SCHEMATIC  
ON / OFF CIRCUIT**

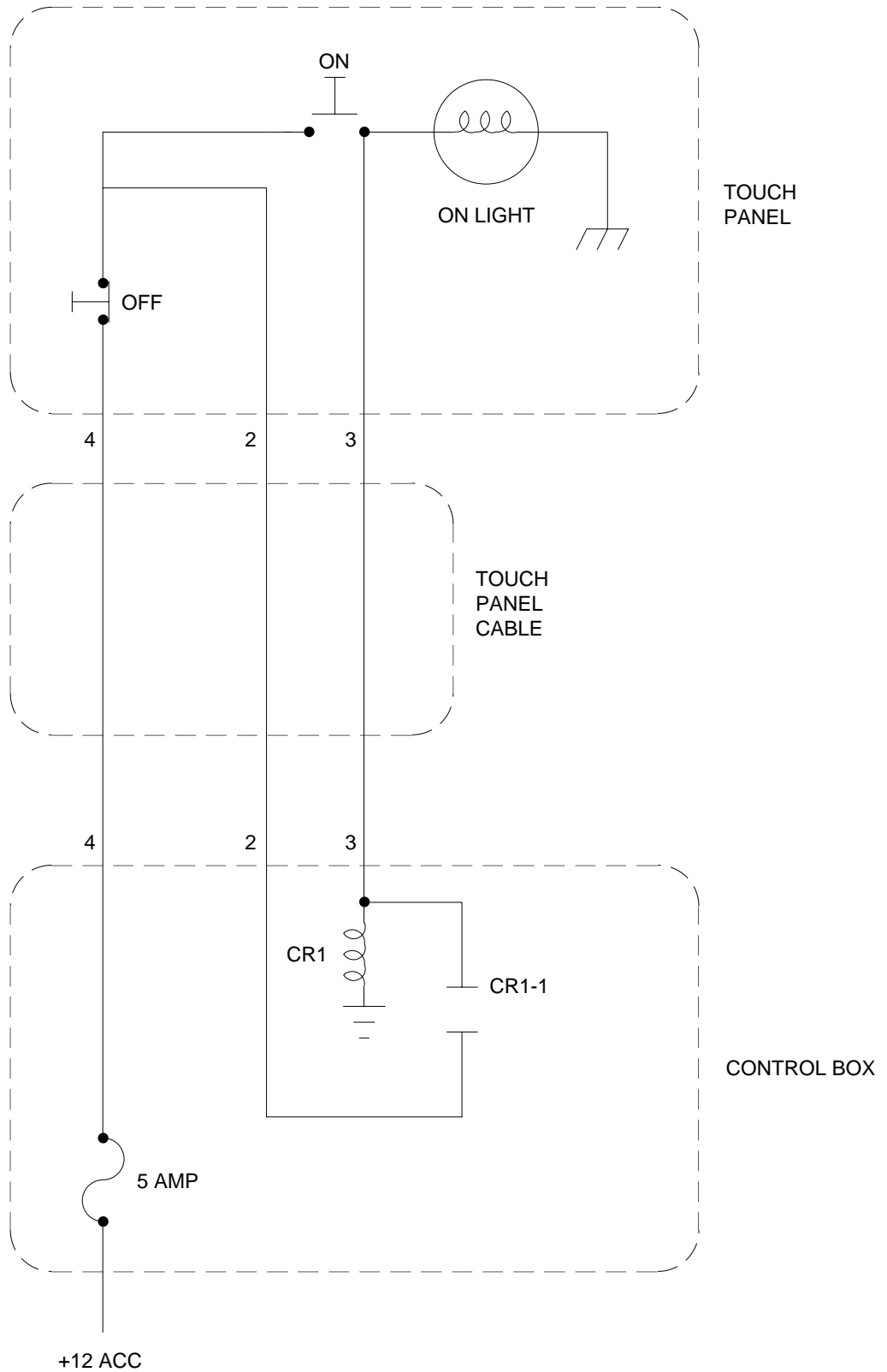

# 310 LEVELING SYSTEM HYDRAULIC MANIFOLD-PUMP RELAY ELECTRICAL CONNECTION DIAGRAM

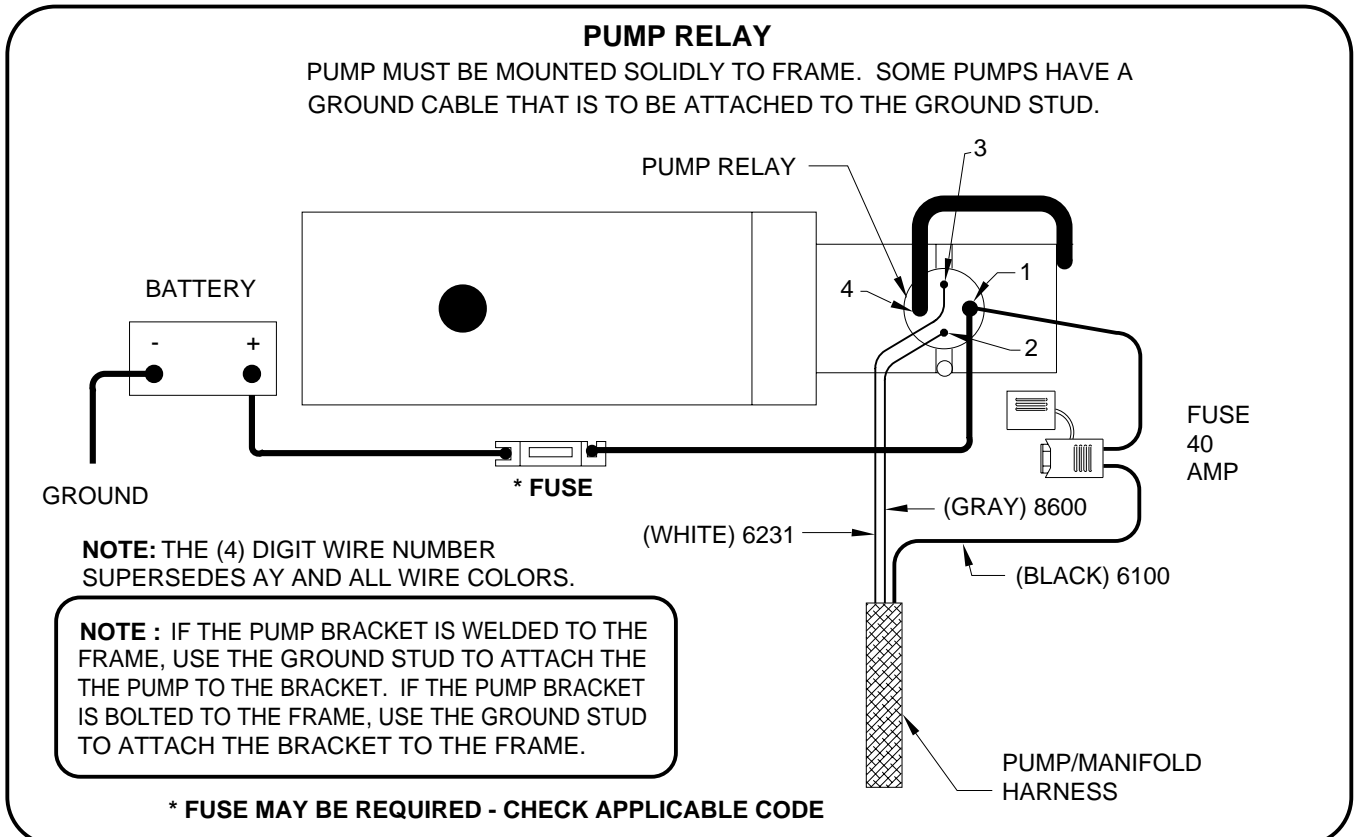
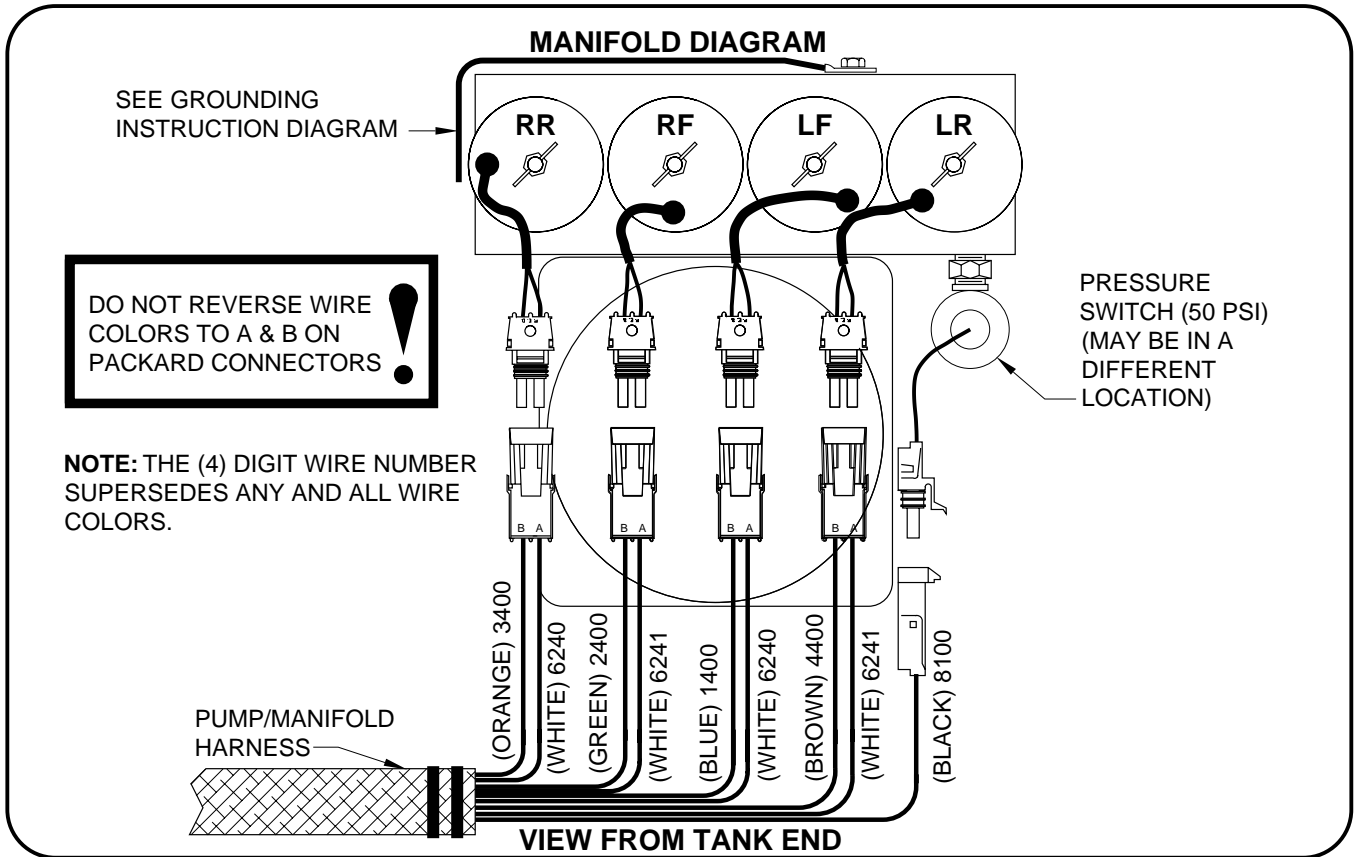

# 310 LEVELING SYSTEM POWER UNIT/HARNESS GROUNDING INSTRUCTIONS

## WELDED PUMP MOUNT

USE GROUNDING STUD AND 3/8" INTERNAL STAR LOCKWASHERS AS SHOWN.

**IMPORTANT:** STAR LOCKWASHER MUST BE USED BETWEEN GROUNDING SURFACE AND WIRE TERMINALS

MANIFOLD GROUND  
SEE HYDRAULIC MANIFOLD/  
PUMP RELAY ELECTRICAL  
CONNECTION DIAGRAM

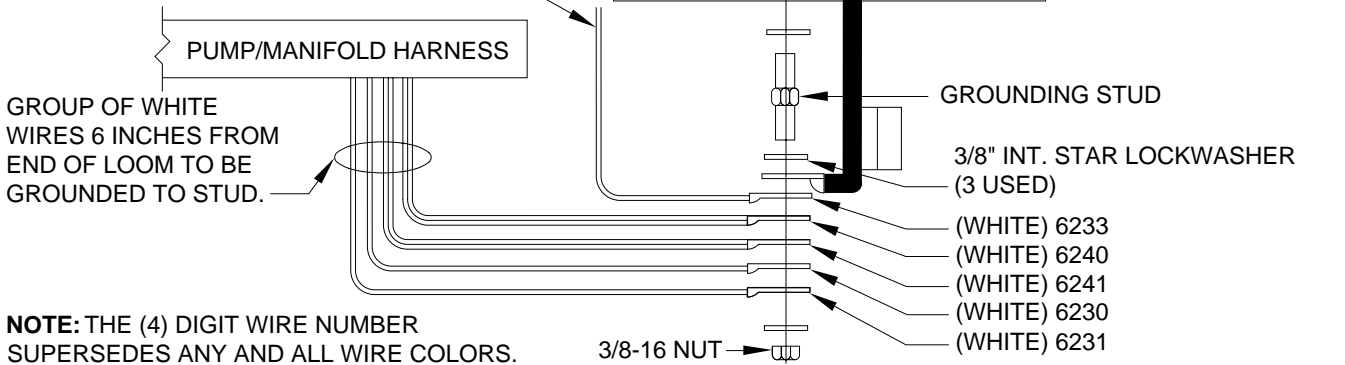

**NOTE:** THE (4) DIGIT WIRE NUMBER SUPERSEDES ANY AND ALL WIRE COLORS.

## PUMP MOUNTED REMOTE FROM FRAME

USE GROUNDING STUD AND 3/8" INTERNAL STAR LOCKWASHERS AS SHOWN.

**IMPORTANT:** STAR LOCKWASHER MUST BE USED BETWEEN GROUNDING SURFACE AND WIRE TERMINALS.

**NOTE:** THE (4) DIGIT WIRE NUMBER SUPERSEDES ANY AND ALL WIRE COLORS.

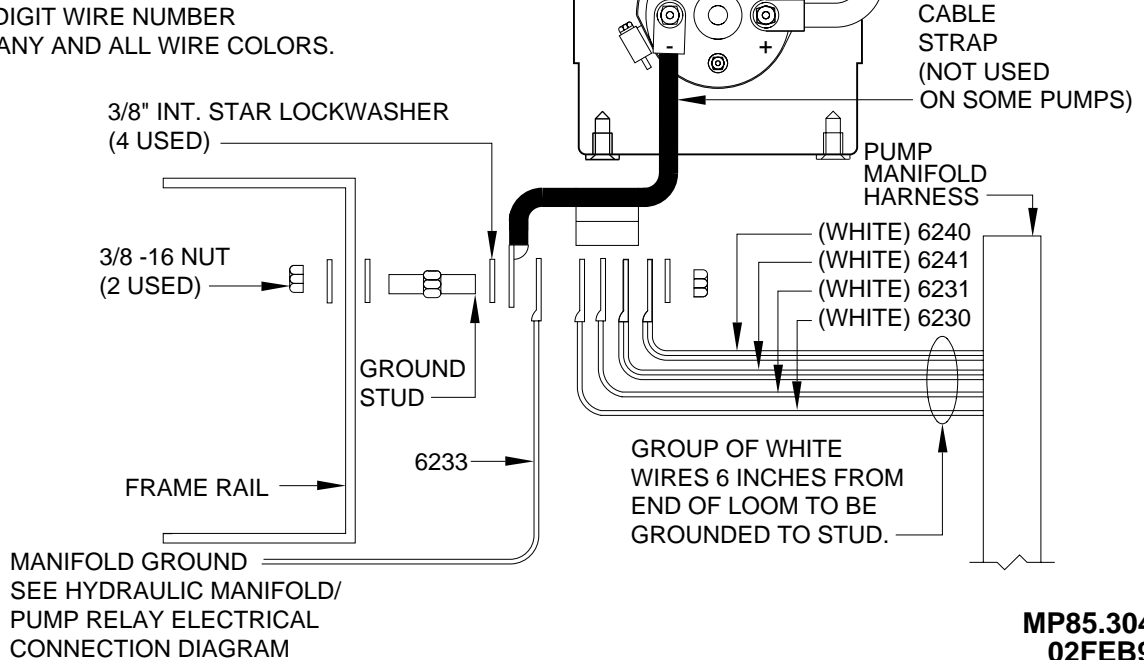

# MASTER LIGHT/BUZZER CONNECTION DIAGRAM MANUAL LEVELING SYSTEMS 310 SERIES

A MASTER WARNING INDICATOR SHOULD ALWAYS BE USED. WHEN THE LEVELING SYSTEM HAS STRAIGHT-ACTING JACKS A WARNING BUZZER MUST BE USED.

WHEN ONLY A RED MASTER WARNING LIGHT IS USED THE +12 POWER FOR THE LIGHT COMES THROUGH THE TOUCH PANEL. (SEE FIGURE 1 BELOW.) WHEN BOTH A RED LIGHT AND WARNING BUZZER ARE USED THE +12 POWER FOR BOTH INDICATORS IS SUPPLIED BY THE IGNITION SWITCH. THE POWER MUST COME FROM THE "ON" SIDE OF THE IGNITION SWITCH, NOT THE "ACC" SIDE. (SEE FIGURE 2 BELOW.)

**NOTE:** BY SUPPLYING IGNITION POWER TO THE WARNING BUZZER AND LIGHT, AND "ACC" POWER TO THE CONTROL BOX, THE SYSTEM MAY BE OPERATED IN ACCESSORY WITHOUT THE BUZZER SOUNDING. THE NEGATIVE SIGNAL FOR THE WARNING INDICATORS MUST ALWAYS COME FROM THE TOUCH PANEL.

**CAUTION:** THE PURPLE WIRE IN THE MASTER WARNING LIGHT PIGTAIL IS HOT WHENEVER THE IGNITION IS "ON" OR IN "ACC". THE PURPLE WIRE MUST BE REMOVED FROM THE PIGTAIL WHEN USING DIRECT IGNITION VOLTAGE FOR THE MASTER WARNING INDICATORS.

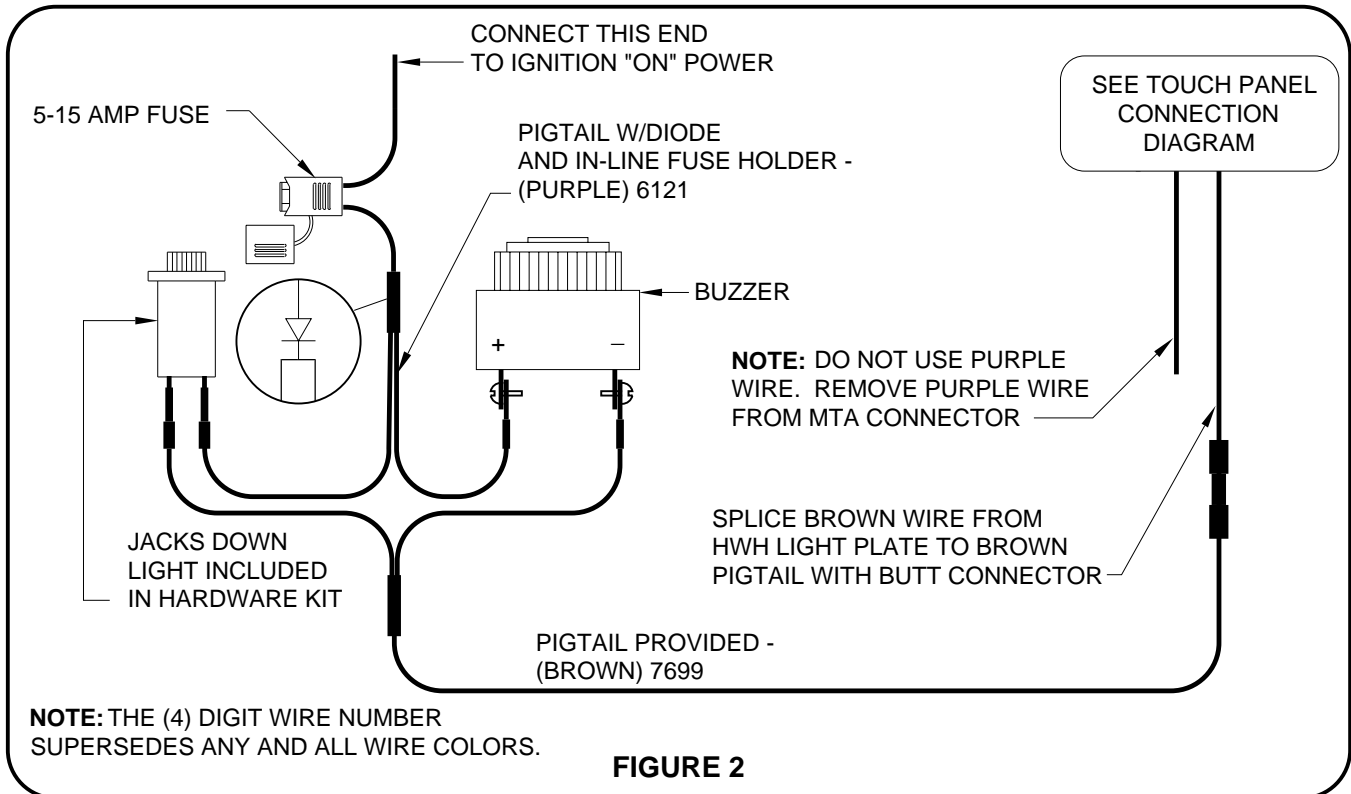
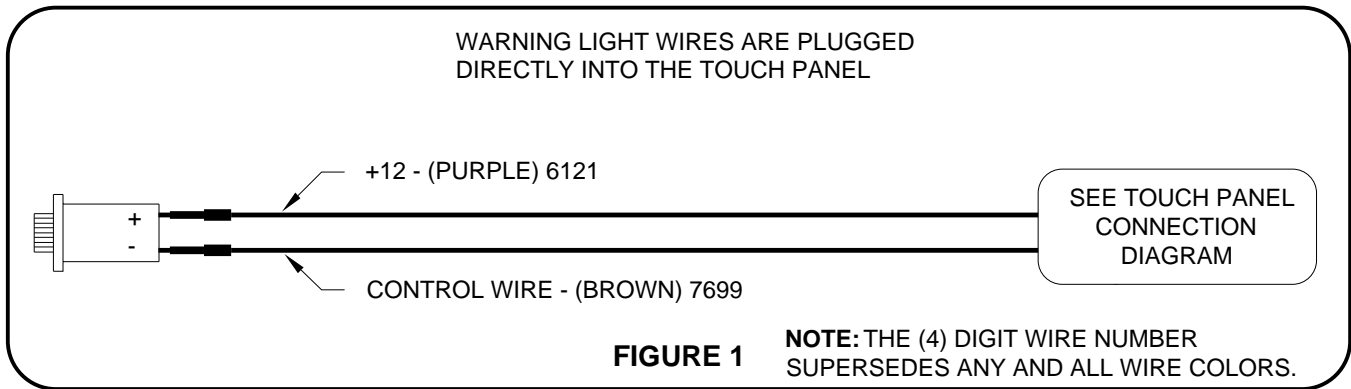

---

# PRESSURE SWITCH

## ADJUSTMENT COMPONENT IDENTIFICATION

---

