

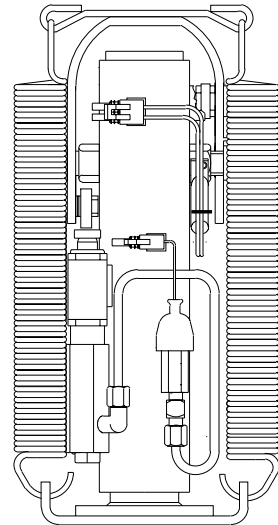

REPAIR MANUAL

HWH COMPUTER-CONTROLLED LEVELING SYSTEM 610 SERIES

FEATURING:
TOUCH PANEL CONTROL
SINGLE HOSE
CENTRAL GROUNDING
KICK-DOWN JACKS
HYDRAULIC LEVELING
STANDARD TWO WIRE WARNING SWITCHES
(OPTIONAL AIR DUMP)

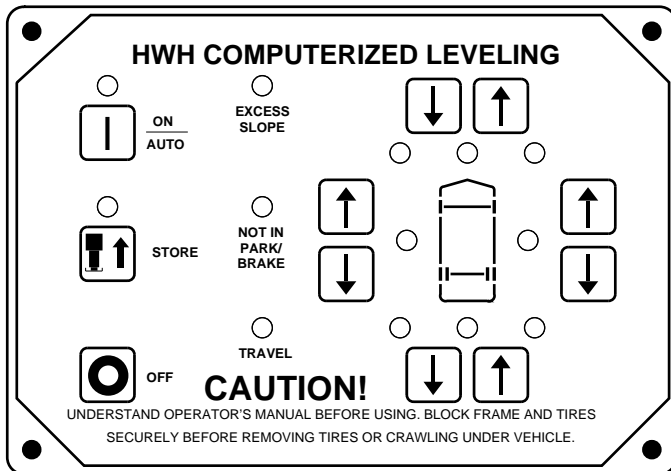

HWH CORPORATION
(ON I-80, EXIT 267 SOUTH)
2096 MOSCOW ROAD
MOSCOW, IOWA 52760
(800) 321-3494 / (563) 724-3396
INTERNET: <http://www.hwhcorp.com>

SECTION 1

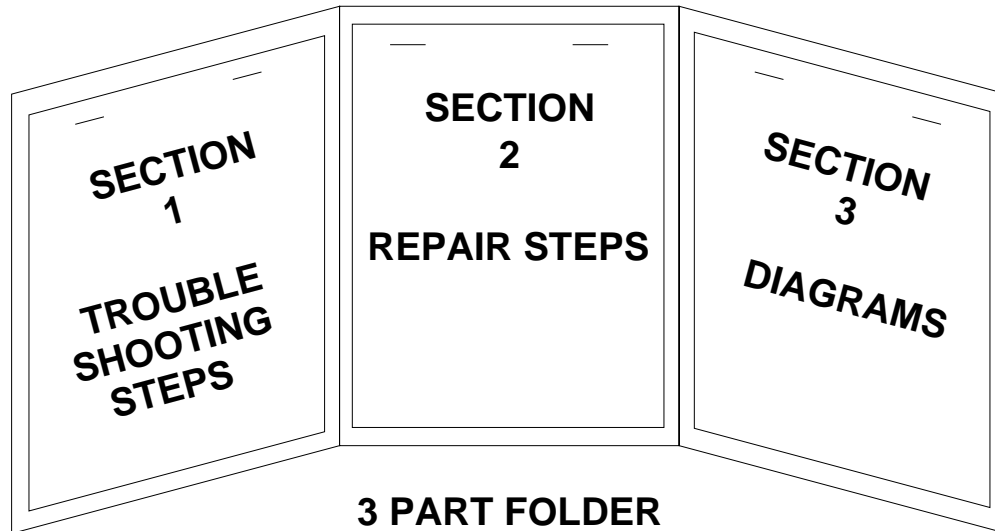

HOW TO USE MANUAL

This manual is written in three sections. Section 1 is the Trouble Shooting Steps. Section 2 is the Repair Steps. Section 3 is the Diagrams. Begin diagnosis of the system with Section 1, the Trouble Shooting Steps. This will give the correct operation and function of the system. When a malfunction is encountered, the trouble shooting steps will direct you to the proper part number in Section 2, the Repair Steps. The Repair Steps are broken into 3 columns, Problem, Solution and Diagrams. In the proper part under Problems, find the symptom you have encountered. The testing and repair for that problem is in the Solution (center) column. Diagrams for a particular problem and solution are in the Diagrams (right hand) column. This column will direct you to the proper Diagram in Section 3, Diagrams, for a more detailed view.

Before beginning your repair, it is **IMPORTANT** to read the **CAUTIONS** and **NOTES AND CHECKS** in the first section, Trouble Shooting Steps. In many cases this will save time and mistakes when trouble shooting a system.

This Repair Manual is offered as a guide only. It is impossible to anticipate every problem or combination of problems. This manual is written in sequential order of the proper operation of the system. The Trouble Shooting Steps must be followed in order to give correct diagnosis of the problem(s). For any problems encountered that are not addressed in this manual, contact HWH CORPORATION for assistance.

PROCEED WITH TROUBLE SHOOTING GUIDE



TROUBLE SHOOTING

CAUTIONS!

BLOCK FRAME AND TIRES SECURELY BEFORE CRAWLING UNDER VEHICLE. DO NOT USE THE LEVELING JACKS OR AIR SUSPENSION TO SUPPORT VEHICLE WHILE UNDER VEHICLE OR CHANGING TIRES. VEHICLE MAY DROP AND OR MOVE FORWARD OR BACKWARD WITHOUT WARNING CAUSING INJURY OR DEATH.

WHEN ROUTING OR REROUTING HYDRAULIC HOSES AND WIRES, BE SURE THEY ARE NOT EXPOSE TO ENGINE EXHAUST OR ANY HIGH TEMPERATURE COMPONENTS OF THE VEHICLE.

THE JACKS MAY ABRUPTLY SWING UP WHEN THE FOOT CLEARS THE GROUND OR WHEN THE JACK REACHES FULL EXTENSION.

NEVER PLACE HAND OR OTHER PARTS OF THE BODY NEAR HYDRAULIC LEAKS. OIL MAY CUT AND PENETRATE THE SKIN CAUSING INJURY OR DEATH.

SAFETY GLASSES ARE TO BE WORN TO PROTECT EYES FROM DIRT, METAL CHIPS, OIL LEAKS, ECT. FOLLOW ALL OTHER SHOP SAFETY PRACTICES.

DO NOT OVER EXTEND THE REAR JACKS. IF THE WEIGHT OF THE VEHICLE IS REMOVED FROM ONE OR BOTH REAR WHEELS, THE VEHICLE MAY ROLL FORWARD OR BACKWARD OFF THE JACKS.

NOTES AND CHECKS

Read and check before preceding with Trouble Shooting Steps.

NOTE: HWH CORPORATION ASSUMES NO LIABILITY FOR DAMAGES OR INJURIES RESULTING FROM THE INSTALLATION OR REPAIR OF THIS PRODUCT.

1. If the jacks cannot be retracted, see Trouble Shooting Step 12 for temporary measures. Make sure the manual retract valves are closed before trouble shooting.

2. The Trouble Shooting Guide must be followed in order. Problems checked for in one step are assumed correct and not checked again in following steps.

3. Check that the oil reservoir is full with the jacks in the fully retracted position.

4. Most vehicles have more than one battery; one for the engine and the other(s) for the vehicle. The engine battery supplies power for the control box and hydraulic pump. DO NOT use the vehicle batteries to supply power to the pump. Batteries should read 12.6 volts. Batteries must be in good condition with no weak cells. The system can draw up to 200 amps. An alternator, convertor, or battery charger will not supply enough power for the system to operate properly.

IMPORTANT: Battery voltage and electrical connections should be checked under load with the pump running.

5. The control box monitors the engine battery during the "AUTOMATIC LEVELING and RETRACT" modes of operation. The battery symbol on the touch panel will light when either of the batteries voltages drop below 8.5 - 9.0 volts, but the system will continue to function. Have the batteries properly charged to their full capacity.

6. Proper ground of all components is critical. See the electrical circuit for specific grounds required. Faulty grounds, especially for the control box, solenoid manifold or the pump assembly, may cause control box component damage and/or

improper or erratic operation.

7. Do not replace the control box unless the Repair Steps say to replace it. Otherwise the malfunctions may damage the new control box.

This manual is intended for use by experienced mechanics with knowledge of hydraulic and automotive electrical systems. People with little or no experience with HWH leveling systems should contact HWH technical service at 1-800-321-3494 before beginning. Special attention should be given to all cautions, wiring, and hydraulic diagrams.

Special note: When installing a new control box, make sure the box is properly grounded before applying power to the system.

Tightening of hose ends: If tightening a new hose end, make the hose end snug (finger tight) on the fitting, then tighten the hose end 1/3 turn (2 FLATS). If tightening an existing hose end, tighten the hose end to snug plus 1/4 turn (1 FLAT).

Suggested tools for trouble shooting the HWH leveling systems:
JUMPER WIRES(UP TO 10 GAUGE)
PRESSURE GAUGE(3500 PSI MIN.)
MULTI-METER and 12 VOLT TEST LIGHT

PROCEED WITH THE TROUBLE SHOOTING STEPS ON THE FOLLOWING PAGE



MI91.1102
19JUN01

TROUBLE SHOOTING STEPS

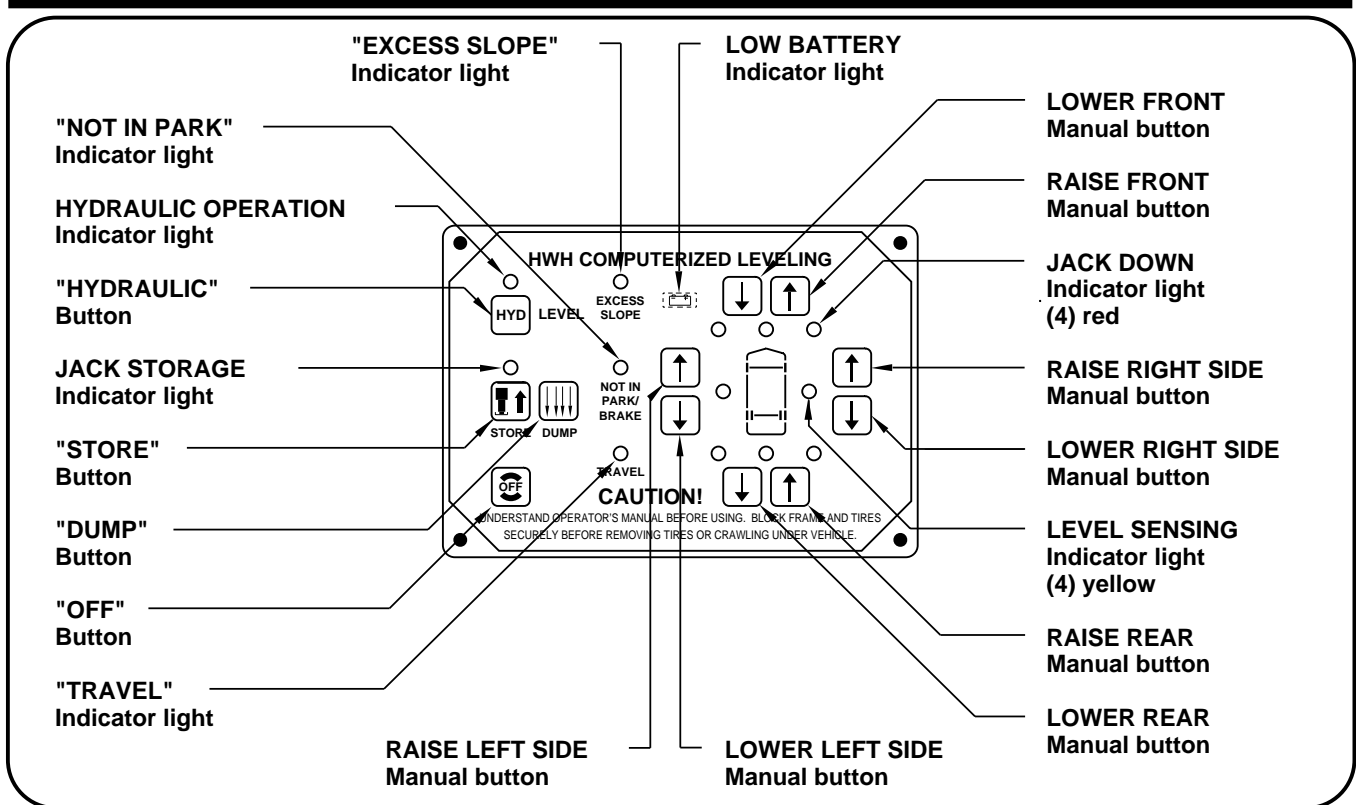

1. Make sure the transmission is in the recommended position for parking and the park brake is set. With the ignition switch off, there would be no power to the leveling system. If any touch panel lights are on, see Part 1 of the Repair Steps.

2. Turn the ignition switch to "ON" or "ACC". Only the green travel light should be lit at this time. If this is not so, see Part 2 of the Repair Steps.

3. Push the "I" (HYD) button one time. The red indicator light above the "I" (HYD) button should glow steady. One or two yellow level indicator lights may be on. The green travel light will still be on. The "NOT IN PARK/BRAKE" light should NOT be lit. The pump should not run. If this is not so, see Part 3 of the Repair Steps.

4. Push the "I" (HYD) button a second time. The red light above the "I" (HYD) button will start to flash. The pump should come on and the four jacks should go vertical. The left front first, the right front second, the right rear third, and finally the left rear. The four red warning lights should be lit. The master warning light on the dash should be lit. The red light above the "I" (HYD) button will glow steady. If any of this sequence does not happen, see Part 4 of the Repair Steps.

NOTE: The vertical operation is a progressive function. As each jack is swinging vertical the microprocessor is looking for a warning switch. A jack can extend and start to lift the vehicle if that warning switch is not working properly. Jack warning switches must work properly for the system to function in the

automatic mode. If a warning switch does not come on, a four second background timer will let the computer go to the next jack.

NOTE: If the **LOW BATTERY** light comes on it will not interfere with the operation of the system, but battery voltage and connections should be checked.

5. With the jacks in the vertical position, the operator can manually operate the jacks with the eight buttons on the right half of the touch panel. The up arrows will lift the vehicle by extending the jacks; whereas the down arrows will lower the vehicle by retracting the jacks. The jacks operate in pairs; left side, right side, front, and rear. Press the up arrow button for each jack pair, checking that the proper pair of jacks operate. Press the down arrows to make sure the jacks will retract properly. If any part of this function does not work properly, see Part 5 of the Repair Steps.

6. Air dump test for vehicles with air dump option. The air dump button will work either with the leveling system off, the ignition on, or with the leveling system on and the jacks in the vertical position. There should be one air dump valve for each height control valve. The air dump valves may be equipped with emergency shutoff valves, make sure they are open. With the system off and the ignition on and the engine running, push the dump button. The air should dump from the suspension while the dump button is pushed. When the dump button is released, the air should stop dumping and the vehicle should return to proper ride height. If this does not function properly, see Part 6 of the Repair Steps Section.

TROUBLE SHOOTING STEPS (CONT'D)

7. Sensing unit check. Put the jacks in the vertical position. If the vehicle is equipped with air dump, dump the air at this time. Using a bubble level inside the vehicle, level the vehicle using the buttons on the right side of the panel as described in Part 5 above. All yellow indicator lights should be off at this time, if not, the sensing unit may need to be adjusted.

When a yellow light is on it indicates that side or end of the vehicle is low according to the sensing unit. Check also that all lights can be made to come on (at different times) by retracting its pair and/or extending the opposing jack pair. If the ground

is sloping or uneven, the vehicle may need to be moved to complete the test. For sensor adjustment procedures or diagnostic procedures, see Part 7 of the Repair Steps.

At this time, manually retract all jacks to their fully stored position. From this point on, it is assumed the system is fully functional in the manual mode. Whenever a malfunction occurs, revert to the manual operation and check for correct functioning. If a problem is found in the manual operation, trouble shoot the problem using the preceding steps. Remember, low volts can cause erratic operation and damage components.

AUTOMATIC LEVELING

8. Turn the ignition switch to the "ON" or "ACC" position. For vehicles with automatic air dump, the engine must be off during leveling. Press the "I" (HYD) button. The red indicator light above the "I" (HYD) button will be lit. Set the park brake if the "NOT IN PARK/BRAKE" light is on. Press the "I" (HYD) button a second time. This will put the jacks in the vertical position. The following should occur:

- a. The red indicator light above the "I"(HYD) button will start to flash.
- b. The pump should start.
- c. The jacks will progressively swing to the vertical position.
- d. Each red warning light on the touch panel will come on as its jack becomes vertical.
- e. The master warning light will be on.
- f. The pump will shut off as the last red warning light comes on.
- g. The red indicator above the "I" (HYD) button will glow steady.

The above portion of the automatic leveling was covered in Parts 1 through 4 of this Section. Refer to Parts 1 through 4 for any malfunction that occurs at this time.

9. Press the "I" (HYD) button the third time. The following should automatically occur.

a. The red indicator light above the "I" (HYD) button will start to flash.

b. Vehicles equipped with automatic air dump will dump the air at this time. The system will dump air for approximately 45 seconds before continuing. The dump valves will remain open until the leveling system has automatically shut itself off.

c. Two jacks at a time will extend corresponding to any yellow lights(s) which is/are lit. This will continue until all yellow level light(s) are out or until two jacks have reached their full extension. If the excess slope light comes on, the system will not stabilize and will shut off in two minutes. Older systems will shut off in ten seconds.

d. After a pause, the pump will come on and run until all remaining jacks not touching the ground, extend to the ground to stabilize the vehicle. Through a pressure switch on each jack, the control box automatically senses when each jack is firmly on the ground. The computer constantly rechecks all the jack pressure switches and will return to any jack that has lost its pressure switch signal until all four jacks have reached the minimum stabilize pressure. If either front jack pressure switch is off, both front jacks will stabilize. Jacks used to stabilize the vehicle should lift the vehicle a minimum of 1/2 inch.

e. The red indicator light above the "I" (HYD) button will stop flashing, the red indicator light will go out as the system shuts off. If any of the above does not function properly, see Part 9 of the Repair Steps.

TROUBLE SHOOTING STEPS (CONT'D)

AUTOMATIC RETRACT PROCEDURE

10. For systems with automatic air dump, start the vehicle engine to build up the air pressure and leave it running. If the dump valves are not closed, see Part 6 of the Section.

11. Push the "I" (HYD) button one time. The red indicator light above the "I" (HYD) button will glow steady. The pump should NOT be running. Push "STORE" button. The following should occur:

- a. The red indicator light above the "STORE" button should start to flash.
- b. The jacks should retract to the horizontal position.
- c. The red warning lights on the touch panel should go out as jacks return to the horizontal position.
- d. The master warning light should go out.
- e. The green "TRAVEL" light should come on.
- f. After six minutes, the red indicator light above the "STORE" button will stop flashing and the computer will automatically shut the system off. The only light that should be lit on the touch panel will be the "TRAVEL" light. If any of the above does not occur, see Part 11 of the Trouble Shooting Section.

NOTE: The system will automatically retract for 6 minutes after all red warning lights are out, unless 1 or more red warning lights stay lit. If a warning light stays lit, the system will continue to retract for 30 minutes and then shut down regardless of any lit warning lights.

CAUTION: UNLESS TROUBLE SHOOTING, THE LEVELING SYSTEM MUST BE ALLOWED TO RETRACT THE FULL 6 MINUTES BEFORE INTERRUPTING POWER TO THE COMPUTER.

12. EMERGENCY JACK RETRACTION. Each solenoid valve is equipped with a "T" handle release valve. Turn the handle counter clockwise approximately 3 turns or until the jacks start to retract. The oil will return to the reservoir and the jack should retract to the horizontal position. After all the jacks are fully retracted, turn the "T" handles clockwise until snug. If no jacks retract, close all T-Handles and make sure the Touch Panel is OFF. Remove then reassemble any one check valve cap. (SEE MP65.5025) The system should then store. If not, contact HWH Customer Service for assistance. See Part 12 of the REPAIR STEPS.

REPAIR STEPS

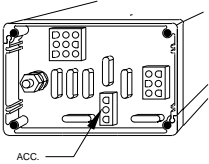
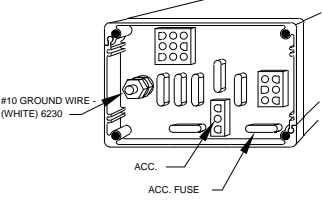
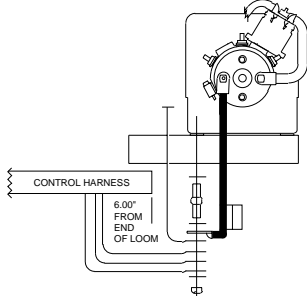
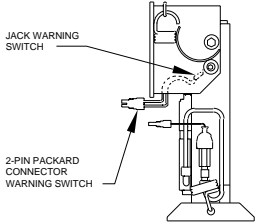
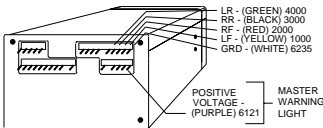
PROBLEM	SOLUTION	DIAGRAMS
<p>Part 1 Touch panel has indicator lights on with the ignition switch off.</p>	<p>There should be no +12 power to the 8" control box. Trace the (BROWN) 6120 wire in the 3 pin UML connector to its source. The wire should be connected to accessory or ignition power. (Accessory power is preferred.) DO NOT use unswitched power for the control box.</p>	 <p>ACC.</p> <p>REFER TO MP85.5001</p>
<p>Part 2 With the ignition switch on:</p> <p>a. The green "TRAVEL" light nor the master "JACKS DOWN" warning light is lit.</p>	<p>With the ignition switch on, the (BROWN) 6120 wire in the 3 pin UML connector should have +12 power. If not, trace the wire to its source. Check any in-line fuses. If +12 power is present, check the 5 amp ACC fuse on the 8" control box. Check that the 10 gauge (WHITE) 6230 wire is properly grounded to the frame. If it is okay, the problem is most likely the 8" control box, but it could be the touch panel, or the cable assembly.</p>	 <p>#10 GROUND WIRE (WHITE) 6230</p> <p>ACC.</p> <p>ACC. FUSE</p> <p>REFER TO MP85.5001</p>  <p>CONTROL HARNESS</p> <p>6.00" FROM END OF LOOM</p> <p>REFER TO MP85.5045</p>
<p>b. The master "JACKS DOWN" warning light is on. (Jacks are all in the stored position.)</p>	<p>Push the "I" (HYD) button one time. A red jacks down warning light on the touch panel should come on, indicating a jack is down. Unplug the jack warning switch. If the red warning light goes out, replace the warning switch. If not, unplug the 9 wire MTA connector for the warning switches at the 8" control box. If the red warning light goes out, the wire to the jack warning switch is shorted to ground. If the red warning light stays on, replace the 8" control box.</p> <p>If no red warning light on the touch panel comes on, check the wires to the master warning light. The control wire for the master warning light may be shorted to ground. If the wires are ok, replace the 8" control box.</p>	 <p>JACK WARNING SWITCH</p> <p>2-PIN PACKARD CONNECTOR WARNING SWITCH</p> <p>REFER TO MP85.5095 REFER TO MP85.5097 REFER TO MP85.5099</p>  <p>LR - (GREEN) 4000 RR - (BLACK) 3000 RF - (RED) 2000 LF - (YELLOW) 1000 GRD - (WHITE) 6235</p> <p>POSITIVE VOLTAGE - (PURPLE) 6121</p> <p>MASTER WARNING LIGHT</p> <p>REFER TO MP85.5001</p>
<p>c. The touch panel has indicator lights on other than the green "TRAVEL" indicator.</p>	<p>Turn the ignition switch off then back on. If the lights do not go out, the problem is most likely the 8" control box, but it could be the touch panel or the modular cable.</p>	

REPAIR STEPS

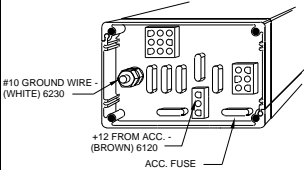
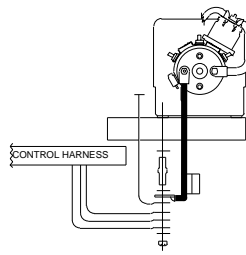
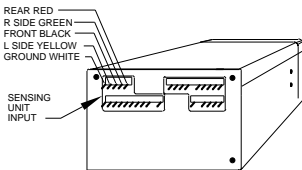
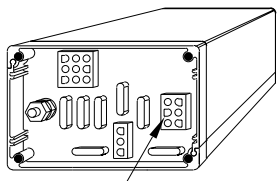
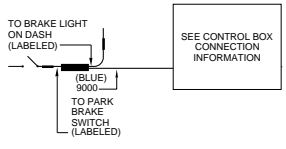
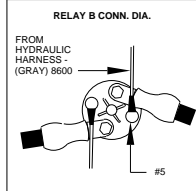
PROBLEM	SOLUTION	DIAGRAMS
<p>Part 3 After pushing the "I" (HYD) button one time:</p> <p>a. The red indicator light above the "I" (HYD) button does not come on.</p>	<p>Check the voltage on the (BROWN) 6120 wire in the 3 pin UML connector. It should be 12.5 volts or more. Check that the 10 gauge (WHITE) 6230 wire is grounded correctly to the central grounding stud. If good voltage is present, replace the control box, touch panel, or cable assembly. If voltage is not present, check the power source for the (BROWN) 6120 wire. Check that the cable between the touch panel and the control box is properly connected.</p>	 <p>REFER TO MP85.5001</p>  <p>REFER TO MP85.5045</p>
<p>b. More than two yellow lights are lit or opposite yellow lights are lit.</p>	<p>Unplug the sensing unit MTA connector from the 8" control box. If the lights DO NOT go out, replace the control box. If the lights go out, connect a 12 volt test light to ground. There are five pins for the sensing unit. One pin for ground and one pin for each yellow level indicator light. Touch each of the four pins for the level indicator lights. Only one light per pin should come on. If this is so, replace the sensing unit. If not, replace the control box.</p>	 <p>REFER TO MP85.5001</p>
<p>c. The "NOT IN PARK/BRAKE" light is lit.</p>	<p>Check that the transmission is in the proper park position and that the park brake is set. Some park brakes automatically set when the transmission is placed in park. Trace the (BLUE) 9000 wire in the 6 pin UML connector to its source. Check for the proper position of the diode arrangement. Check the brake switch for proper function.</p> <p>NOTE: Most coaches complete a ground signal through the brake switch, but some do have a +12 signal. Make sure the proper box is being used. Use a jumper wire to apply the proper signal to the (BLUE) 9000 wire. If the "NOT IN PARK/BRAKE" light does not go out, replace the control box.</p>	 <p>REFER TO MP85.5001</p>  <p>REFER TO MP85.5003</p>
<p>d. The pump comes on at this time.</p>	<p>If possible, release the park brake. If the pump continues to run replace relay B. Otherwise, check Terminal 5 with a 12 volt test light connected to ground. If +12 volts is present, the problem is with the control box. If +12 is NOT present, replace relay B.</p>	 <p>REFER TO MP85.5030</p>

REPAIR STEPS

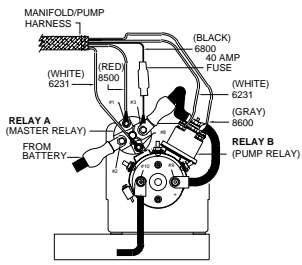
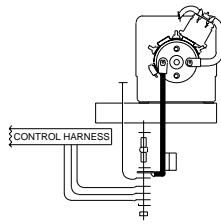
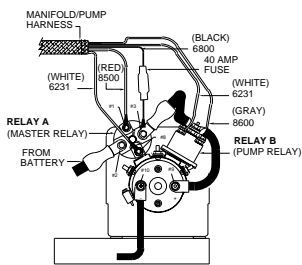
PROBLEM	SOLUTION	DIAGRAMS
<p>Part 3 (cont'd)</p> <p>e. All the indicator lights on the touch panel come on.</p>	<p>If all the indicator lights come on and stay on, replace the control box. If this does not fix the problem, replace the touch panel.</p> <p>NOTE: All indicator light will flash momentarily when turning the system on.</p>	
<p>Part 4 After pushing the "I" (HYD) button a second time:</p> <p>a. The red indicator light above the "I" (HYD) button does not flash.</p>	<p>Push the "OFF" button, then the "I" (HYD) button twice. If the light still does not flash, replace the control box.</p>	
<p>b. The low battery indicator light comes on, but the pump runs and the jacks go vertical.</p>	<p>The low battery indicator light will come on if the voltage at the control box drops below 8.5 to 9.0 volts. The system will continue to function, but the batteries and all connections should be checked. Continuously running the system under low voltage conditions can damage electrical components.</p>	<p>REFER TO MP85.5030 REFER TO MP85.5045 REFER TO MP85.5003</p>
<p>c. The pump does not come on.</p>	<p>If the low volts indicator comes on, push the "OFF" button then the "I" (HYD) button one time. Check Terminals 1, 2, and 3 of relay A. They should have +12 volts. If Terminal 1 does not have +12 volts, the control box, acc. fuse or the (red) 8500 wire is bad. If Terminal 2 has no voltage, check the cable, cable ends and the battery. If Terminal 3 has no voltage, connect a test light to Terminal 2 and check Terminal 8. Terminal 8 supplies the ground for Relay A. If the test light comes on, replace Relay A. If the test light does not come on, check that all wires are properly hooked up to the grounding stud and that the grounding stud is tight and properly attached to the coach frame. The (white) 6231 wire on Terminal 8 could be bad. Check the 40 amp fuse in the inline fuse holder on the #10 wire (black) 6800 connected to Terminal 3. If Terminals 1, 2, and 3 are okay, proceed.</p> <p>The following test must be performed while the red indicator light above the "I" (HYD) button is flashing. Push the "I" (HYD) button a second time. With a test light hooked to ground, check Terminals 5 and 6 while the light is flashing. If Terminal 5 has no voltage, check the pump fuse at the control box. If the fuse is good replace the control box. If the fuse is blown the (gray) 8600 wire may be shorted or relay B may be bad.</p> <p>If Terminal 5 has voltage but not Terminal 6, check Terminal 7 with a test light hooked to Terminal 2 of Relay A. Terminal 7 supplies the ground for Relay B. If the test light comes ON, replace Relay B. If the test light does not come on, check the connections at the grounding stud. Make sure the grounding stud is properly attached to the frame. The (white) 6231 wire could be bad.</p> <p>If Terminals 5 and 6 have voltage, check the connection at Terminal 9. Check that the connection at Terminal 10 is tight. Check that the pump ground cable is properly attached to the grounding stud.</p> <p>NOTE: Some pumps will not have Terminal 10 or a ground strap. Check that the pump has a good solid frame mount. If all connections and mountings are okay, replace the pump.</p>	<div style="text-align: center;">  </div> <p style="text-align: center;">REFER TO MP85.5030</p> <div style="text-align: center;">  </div> <p style="text-align: center;">REFER TO MP85.5045</p> <div style="text-align: center;">  </div> <p style="text-align: center;">REFER TO MP85.5030</p>

REPAIR STEPS

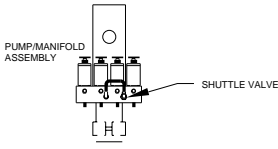
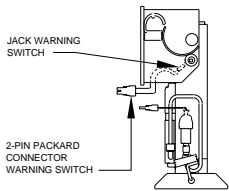
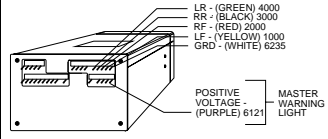
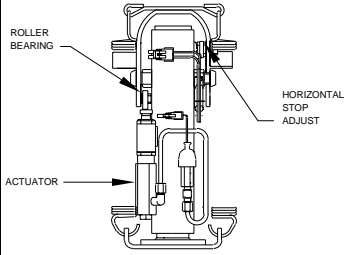
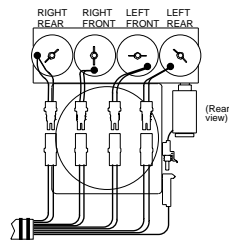
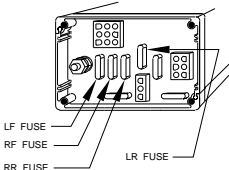
PROBLEM	SOLUTION	DIAGRAMS
<p>Part 4 (cont'd)</p> <p>d. Pump runs under no load and nothing happens.</p>	<p>Disconnect the pressure tube between the manifold and shuttle valve. Connect the pressure gauge to the fitting in the manifold. (Not the shuttle valve.) Turn the pump on for 5 to 10 seconds. The pressure should be approximately 3500 psi. If there is low pressure, change the power unit. If the pressure is ok, change the shuttle valve.</p>	 <p style="text-align: center;">REFER TO MP65.5025</p>
<p>e. A jack is vertical and extended, but its red warning light is not lit.</p>	<p>Return the jacks to the horizontal position. With the panel "ON" pull each jack vertical by hand while someone watches the panel. Make sure the respective red light for each jack comes "ON". Unplug the jack warning switch for the light not working. The warning switch has a 2-pin connector. Put a jumper wire between the 2 pins of the harness connector not the warning switch connector. If the light comes on, replace the warning switch. If the light does NOT come on, unplug the orange MTA connector for the warning switches at the control box. Use a 12 volt test light connected to the ground pin for the warning switch inputs. Touch each pin in the control box. If the red warning lights work properly, the wire from the jack is bad. If the red lights do NOT come on, replace the control box.</p> <p>CAUTION: A JACK WILL ABRUPTLY SWING TO THE HORIZONTAL POSITION WHEN RELEASED.</p>	 <p style="text-align: center;">REFER TO MP85.5095 REFER TO MP85.5097 REFER TO MP85.5099</p>  <p style="text-align: center;">REFER TO MP85.5001</p>
<p>f. A jack is not vertical nor is its red light on. The jack has not extended in the horizontal position.</p>	<p>On a new installation or after a repair, there could be air in the lines. Turn the system off and retry several times. The jacks go vertical in a set order, left front, right front, right rear, left rear. If the system is plumbed or wired incorrectly, one or two jacks may not go vertical. If there is no pause between the jacks going vertical, check the plumbing and wiring. Check that the roller bearing or actuator cable is okay. Check that jack stops are okay and adjusted properly. Check that the actuator rod moves freely. If there is no change, then the problem is either a bad solenoid valve, actuator or control box. Check the 10 amp fuse for the malfunctioning jack. If the problem is a front jack, interchange the wires for the front solenoids at the solenoid manifold. If the problem is a rear jack, interchange the wires for the rear solenoids. Retract and try the vertical mode again. If the problem stays with the same jack, the problem is the solenoid valve or actuator. Retract the system. Remove the hose from the jack and retry. If there is fluid flowing from the hose, the problem is the actuator. If no fluid flows from the hose, replace the solenoid valve. If the problem follows the wire, change the control box.</p> <p>NOTE: Remove the warning switch harness plug from the control box for this test. Remember to replace the harness and make sure all components are correctly plugged in after the testing is completed.</p>	 <p style="text-align: center;">REFER TO MP85.5095 REFER TO MP85.5097 REFER TO MP85.5099</p>  <p style="text-align: center;">REFER TO MP85.5040</p>  <p style="text-align: center;">REFER TO MP85.5001</p>
<p>g. A jack has extended in the horizontal position.</p>	<p>Check that the roller bearing or actuator cable is okay. Check that the horizontal stop is okay and adjusted properly. If these parts are okay, the problem is in the actuator and it should be replaced.</p>	<p style="text-align: center;">REFER TO MP85.5095 REFER TO MP85.5097 REFER TO MP85.5099</p>

REPAIR STEPS

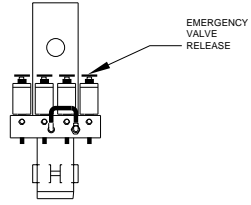
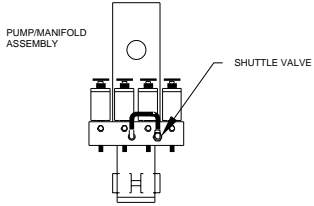
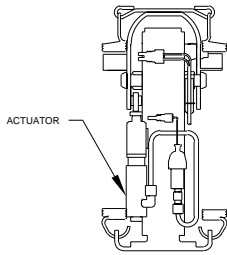
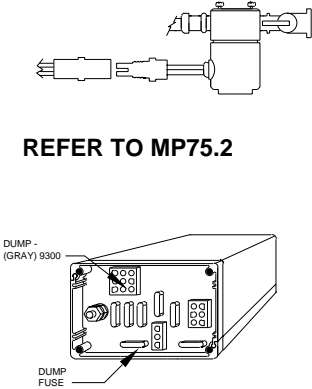
PROBLEM	SOLUTION	DIAGRAMS
<p>Part 4 (cont'd)</p> <p>h. After going vertical, a jack returns to the horizontal position after the pump shuts off.</p>	<p>Push the "OFF" button. Push the "I" (HYD) button twice. As the problem jack goes vertical and its red light comes on, push the "OFF" button. If the jack stays vertical, the control box is the problem. If the jack retracts, the problem is the solenoid valve or the actuator. Check that the emergency release valve on the solenoid valve is closed tight. Push the "I" (HYD) button twice. Push the raise manual button that will operate that jack. Hold the button until the jack kicks vertical and extends and lifts the coach. Release the button. If the jack retracts, replace the solenoid valve for that jack. If it does NOT retract, the problem is probably the actuator on that jack.</p>	 <p style="text-align: center;">REFER TO MP65.5025</p>
<p>Part 5 When manually operating the jacks:</p> <p>a. A jack extends but will not lift the coach.</p>	<p>If one or more jacks will extend and lift the coach and the jack swings to the vertical position okay, the actuator or the jack is bad and should be replaced. If none of the jacks will lift the coach, disconnect the tube between the shuttle valve and the manifold. Connect a pressure gauge to the manifold fitting and check the pump pressure. It should be approximately 3500 psi. If the pump pressure is okay, replace the shuttle valve.</p>	 <p style="text-align: center;">REFER TO MP65.5025</p>
<p>b. A jack will not retract.</p>	<p>Refer to Part 12 of Section 1. If the T-handle release does not work, bleed pressure off the jack according to the following directions. For a 9000# jack, bleed pressure off between the jack and the actuator. If the jack will not retract, replace the jack. If the jack starts to retract, tighten the actuator tube and bleed pressure off between the actuator and the hydraulic supply line. If the jack does not retract, replace the actuator. If the jack starts to retract, then the problem is probably the solenoid valve, velocity valve or a voltage problem. Check for +12 volts, and ground at the valve. If voltage is present, the problem is the solenoid valve or velocity valve. If voltage is not present, check for +12 at the control box. If voltage is present, the problem is the harness. If voltage is not present check the fuse for that valve. If the fuse is OK, replace the control box. If the fuse is blown the harness or valve may be bad. For 6000# or 16,000# jacks, bleed pressure between the actuator and the hydraulic supply line. If the jack does not retract, replace the jack. If the jack does retract, the problem is probably the solenoid valve, velocity valve or a voltage problem. A stuck shuttle valve could keep the system from retracting, but if it is a shuttle valve, none of the jacks would retract.</p>	 <p style="text-align: center;">REFER TO MP85.5095 REFER TO MP85.5097 REFER TO MP85.5099</p>
<p>Part 6</p> <p>a. Air will not dump from the suspension.</p>	<p>With the leveling system off and the ignition on, check between the wires going to the air dump valves for +12 volts while the dump button is being pushed. If +12 volts is present, replace the valve. If +12 is not present, check the 5 amp air dump fuses. Check for +12 volts on the (GRAY) 9300 wire in the 9 pin UML connector at the control box. If +12 is not present, replace the control box. Check that the white wire has a good ground.</p> <p>NOTE: Some air dump valves are equipped with an emergency shut off valve. Make sure this valve is open.</p>	 <p style="text-align: center;">REFER TO MP75.2</p> <p style="text-align: center;">REFER TO MP85.5005</p>
<p>b. Air dump valves will not close.</p>	<p>With the ignition on, check the (GRAY) 9300 wire in the 9 pin UML connector at the box. If +12 volts is present, replace the control box. If +12 volts is not present, replace the air dump valve. If the valve is closed but the coach will not return to the proper height, the problem is probably in the height control valve or the air supply for the suspension system.</p>	<p style="text-align: center;">REFER TO MP85.5005</p>

REPAIR STEPS

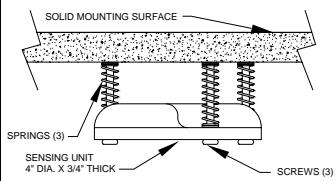
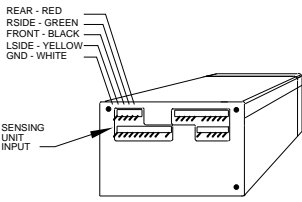
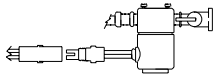
PROBLEM	SOLUTION	DIAGRAMS
<p>Part 7 Yellow level indicator lights do not work properly.</p>	<p>The sensing unit is a 4 inch diameter disk that is usually mounted on the under side of the coach towards the middle of the coach. Occasionally it will be found inside the coach or in a storage compartment. Check that the unit is not mounted, nor the wires routed near a heat source. Check that the sensing unit is mounted correctly according to the sticker on the sensing unit. The sensing unit is adjusted by drawing up the corresponding screws (if the sensing unit is mounted under the coach) to put out the yellow lights. If the yellow lights are not working properly, unplug the sensing unit at the control box. Using a 12 volt test light connected to ground, touch each pin in the control box for the sensing unit. Check that the proper yellow light on the touch panel comes on when its pin is touched. If there is a malfunction here, replace the control box. If the control box is okay, replace the sensing unit. Remember to keep the sensing unit away from any heat source.</p>	 <p style="font-size: small;">SOLID MOUNTING SURFACE SPRINGS (3) SENSING UNIT 4" DIA. X 3/4" THICK SCREWS (3)</p> <p style="text-align: center;">REFER TO MP85.9505</p>  <p style="font-size: small;">REAR - RED RSIDE - GREEN FRONT - BLACK LSIDE - YELLOW GND - WHITE</p> <p style="font-size: small;">SENSING UNIT INPUT</p> <p style="text-align: center;">REFER TO MP85.5001</p>
<p>Part 8 After pressing the "I" (HYD) button two times:</p> <p>The first part of automatic leveling was covered in Parts 1 through 4 of this Section.</p>	<p>AUTOMATIC LEVELING</p> <p>If there is any problem with Part 8a through 8g refer to Parts 1 through 4 of Section 1.</p>	
<p>Part 9 After pushing the "I" (HYD) button a third time:</p> <p>a. The red indicator light does not flash.</p>	<p>The problem is the touch panel or the control box.</p>	
<p>b. The air does not dump at this time. (If applicable.)</p>	<p>Recheck Part 6a of this Section. If the air will dump manually but not automatically, replace the control box. If the air will not dump at all, check that the correct control box was used.</p>	 <p style="text-align: center;">REFER TO MP75.2</p>

REPAIR STEPS

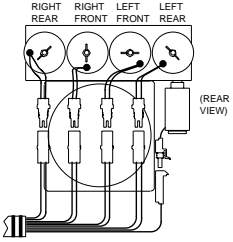
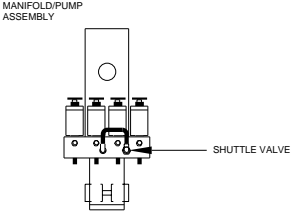
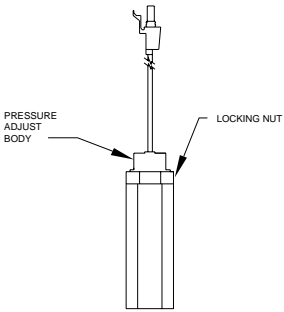
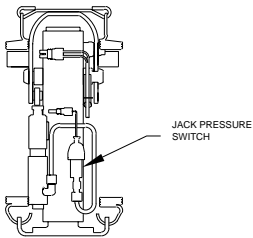
PROBLEM	SOLUTION	DIAGRAMS
<p>Part 9 (cont'd)</p> <p>c. The coach will not level correctly according to the yellow level indicator lights.</p> <p>The "EXCESS SLOPE" light comes on when it shouldn't or won't come on when it should</p> <p>NOTE: The "EXCESS SLOPE" light will not come on during manual operation, only during automatic operation.</p>	<p>It is assumed at this point wiring and hose routings have been checked and are okay. It is also assumed the sensing unit is functioning properly. Recheck the manual operation of the system. If the excess slope light is coming on and a jack has not reached full extension, unplug the wires to the pressure switch on the manifold and retry. If it now works, replace the pressure switch. If not, the jacks may be too small. Check with HWH. If the excess slope light will not come on when two jacks reach full extension, disconnect the tube between the shuttle valve and the manifold. Check the pump pressure. If the pump pressure is okay, retry in automatic leveling and short the wires to the pressure switch together while the pump is running with a yellow light on. If the excess slope light comes on replace the pressure switch. If the light does not come on, replace the control box. During the leveling process, at no time should any jack retract. If the coach or a corner of the coach seems to drop or a jack is retracting while the pump is running, the problem is an internal check valve. Contact HWH CORPORATION, 1-800-321-3494, for the proper repair procedure.</p> <p>NOTE: If the "EXCESS SLOPE" light is on but no yellow level lights are on, the problem is a jack pressure switch. See Part 9d. of the REPAIR STEPS.</p>	<p>DIAGRAMS</p>  <p>REFER TO MP85.5040</p>  <p>REFER TO MP65.5025</p>
<p>d. One or more jacks are not stabilizing the coach properly.</p>	<p>One or more jacks do not reach the ground. At this point it is assumed that all jacks will extend and lift the vehicle. If the jack does not attempt to move to stabilize the vehicle, unplug the jack pressure switch for that jack and retry. If the jack now extends and lifts the vehicle during stabilize, replace the pressure switch. If it still does not move, review Part 5 of Section 1.</p> <p>NOTE: With a jack pressure switch unplugged, the jack will lift the vehicle out of level. Do not allow the jack to over extend when performing this test.</p> <p>If a jack extends but does not reach the ground or lift the coach enough, first adjust the pressure switch. Remove the rubber boot from the body of the switch. Unplug the wire so it can rotate freely. Loosen the locking nut and turn the pressure adjust body 1/2 turn clockwise. Retry then repeat the procedure if still not stabilizing. If adjusting the switch does not help, replace the switch. A jack should lift the coach at least 1/2" during stabilize.</p> <p>One or more jacks lift the coach too much during stabilize. The computer must see both front jack pressure switches before stopping the front jacks. If one front jack pressure switch needs adjustment or is bad, both jacks will lift too much. To adjust the pressure switch to decrease the amount of lift during stabilize, remove the rubber boot from the switch body. Unplug the wire so it can rotate freely. Loosen the locking nut. Turn the pressure adjust body counterclockwise 1/2 turn.</p> <p>Retry and repeat the procedure until the system properly stabilizes the coach. A jack should lift the coach at least 1/2" during stabilize. If adjusting one front switch does not help, try adjusting the other front switch. The rear jacks pressure switches work individually. If adjusting the switches does not help, replace the pressure switch. To determine which front switch is bad, unplug either switch. Use a jumper wire to ground harness pin. Retry the system. If the jacks continue to lift too much the switch that remains plugged in is bad and should be changed. If the front jacks now stabilize properly, replace the switch that is unplugged.</p>	 <p>REFER TO MP85.5020</p>  <p>REFER TO MP85.5095 REFER TO MP85.5097 REFER TO MP85.5099</p>

REPAIR STEPS

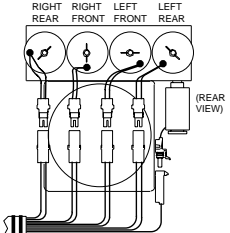
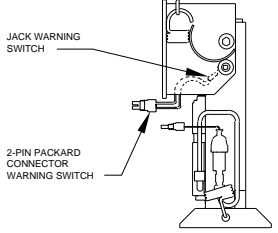
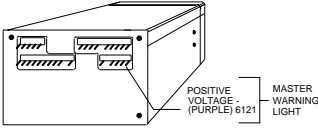
PROBLEM	SOLUTION	DIAGRAMS
<p>Part 10 The coach will not return to ride height.</p>	<p>AUTOMATIC RETRACT</p> <p>The air dump solenoids are not closing. Recheck Part 6b of this Section. Some air solenoids are equipped with emergency shutoff valves. If the dump valves are closed, the height control valve or air supply for the suspension system may be the problem.</p>	
<p>Part 11 After pushing the "I" (HYD) button one time and pushing the "STORE" button:</p> <p>a. The pump comes on after pushing the "I" (HYD) button one time.</p>	<p>Solenoid B, the pump solenoid, is probably stuck. The system cannot retract if the pump is running. Recheck Part 3d of this Section.</p>	
<p>b. A jack will not retract to the horizontal position, but works properly in the automatic and manual leveling modes.</p>	<p>Unplug the left front and the left rear solenoid valves. Put the system in the "STORE" mode. If the right side jacks retract, replace the left rear solenoid valve.</p> <p>Unplug the right front and the right rear solenoid valves. Put the system in the "STORE" mode. If the left side jacks retract, replace the right front solenoid valve.</p> <p>Alternate method: With a continuity tester check continuity from pin "A" of the solenoid valve packard connector to the case of the valve. If continuity is present, replace the solenoid valve.</p>	 <p style="text-align: right;">(REAR VIEW)</p> <p style="text-align: center;">REFER TO MP85.5040</p>
<p>c. Red warning lights on the touch panel do not go out, but the jacks have retracted.</p>	<p>Unplug the warning switch wire. If the light goes out, replace the warning switch. If the light does not go out, check the wire for a short to ground. If the wire is okay replace the control box.</p>	 <p style="text-align: center;">REFER TO MP85.5095 REFER TO MP85.5097 REFER TO MP85.5099</p>
<p>d. The master "JACKS DOWN" warning light on the dash will not go out.</p>	<p>Unplug the 6 pin MTA connector and check the ground wire (BROWN) 7699 going to the master warning light. If it is not shorted to ground, replace the control box. This light should be on whenever a warning light on the touch panel is on.</p>	 <p style="text-align: center;">REFER TO MP85.5001</p>

REPAIR STEPS

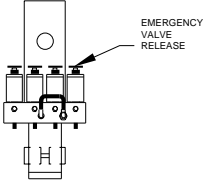
PROBLEM	SOLUTION	DIAGRAMS
<p>e. The green travel light will not come on if any red warning lights are on. If no red warning lights are lit, replace the control box.</p>		
<p>Part 12 Jacks will NOT retract using the T-handle release on the solenoid valves.</p>	<p>If none of the jacks will retract using the T-handles, the shuttle valve is bad.</p> <p>If only one jack will not retract using the T-handles, loosen the hydraulic line for that jack. If the jack retracts, replace the solenoid valve. If the jack does not retract, the hose could be kinked or the actuator or jack is bad.</p>	 <p>EMERGENCY VALVE RELEASE</p> <p>REFER TO MP65.5025</p>

HYDRAULIC SCHEMATIC BI-AXIS LEVELING WITH KICK-DOWN JACKS

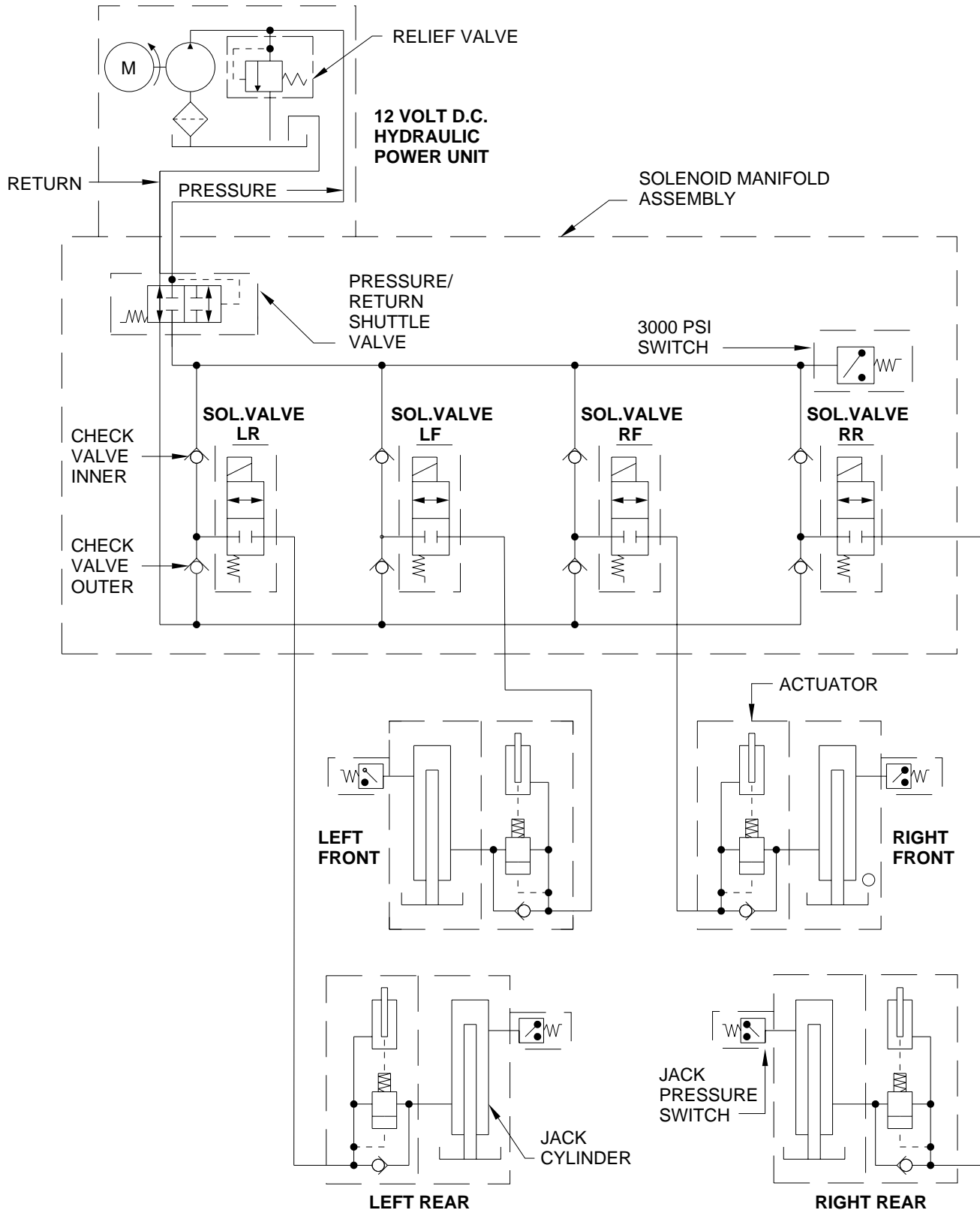

HYDRAULIC LINE CONNECTION DIAGRAM

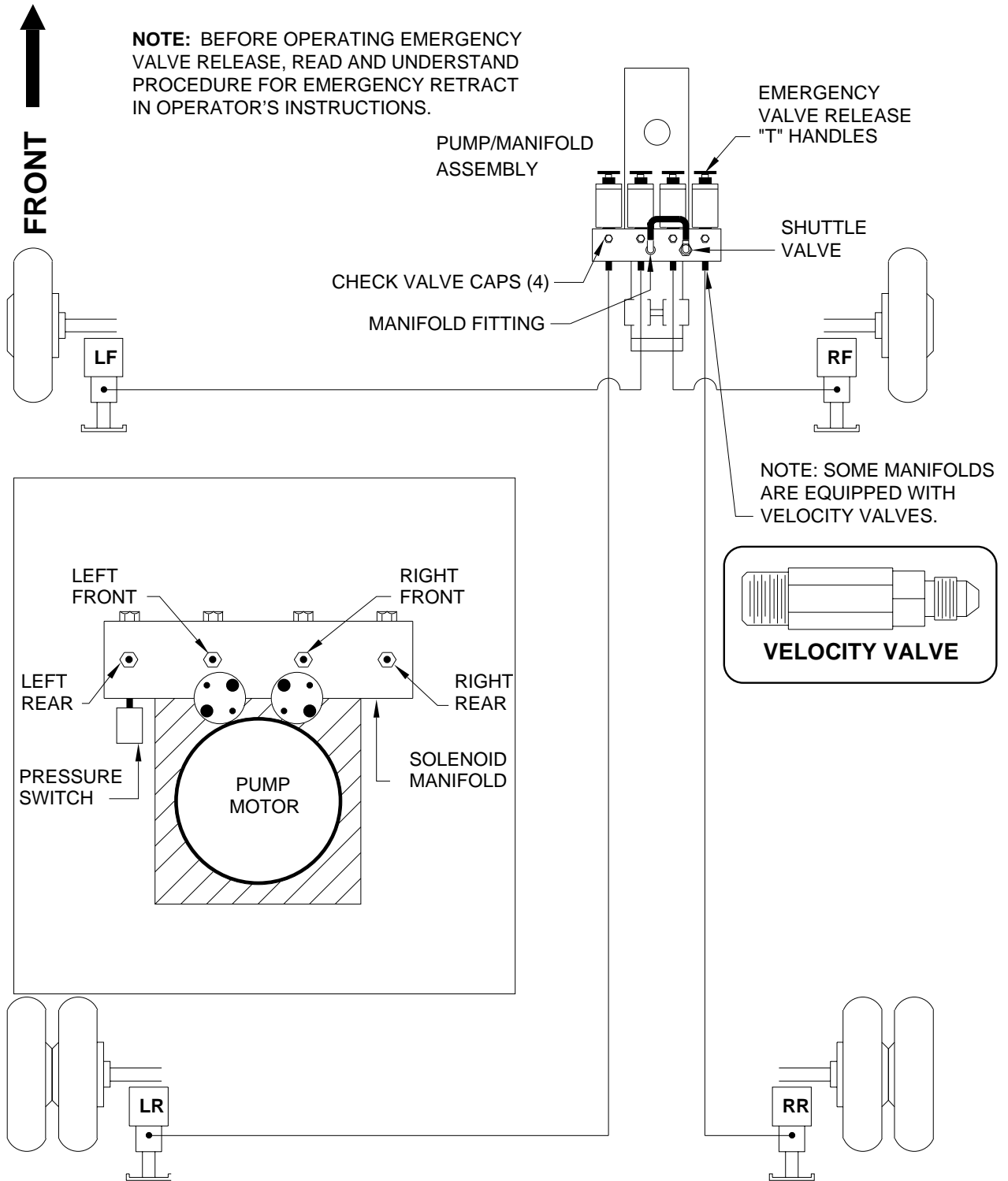

AIR LINE CONNECTION DIAGRAM

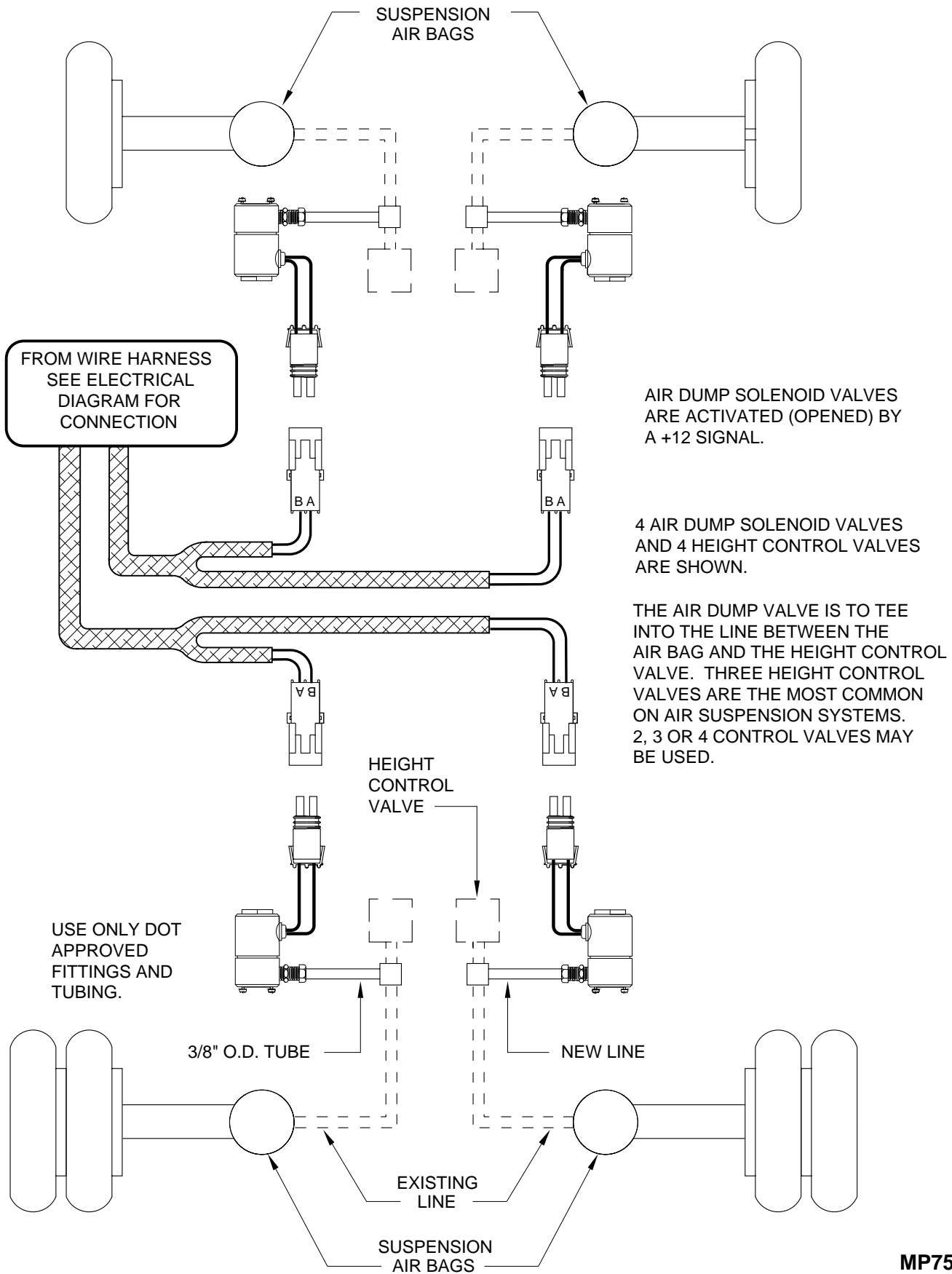

CONNECTION INFORMATION

610 SERIES LEVELING SYSTEM

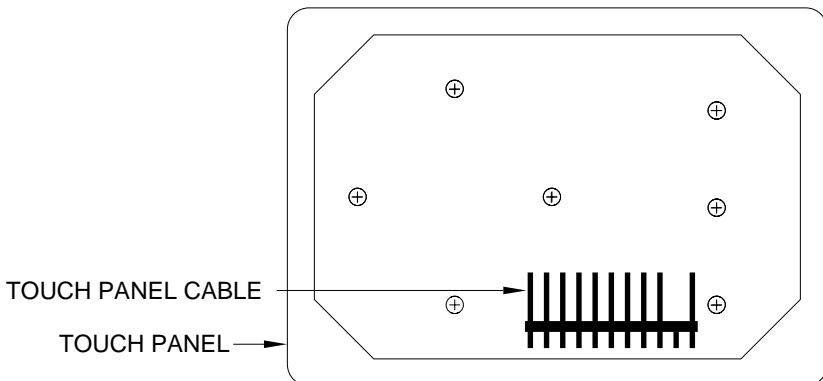
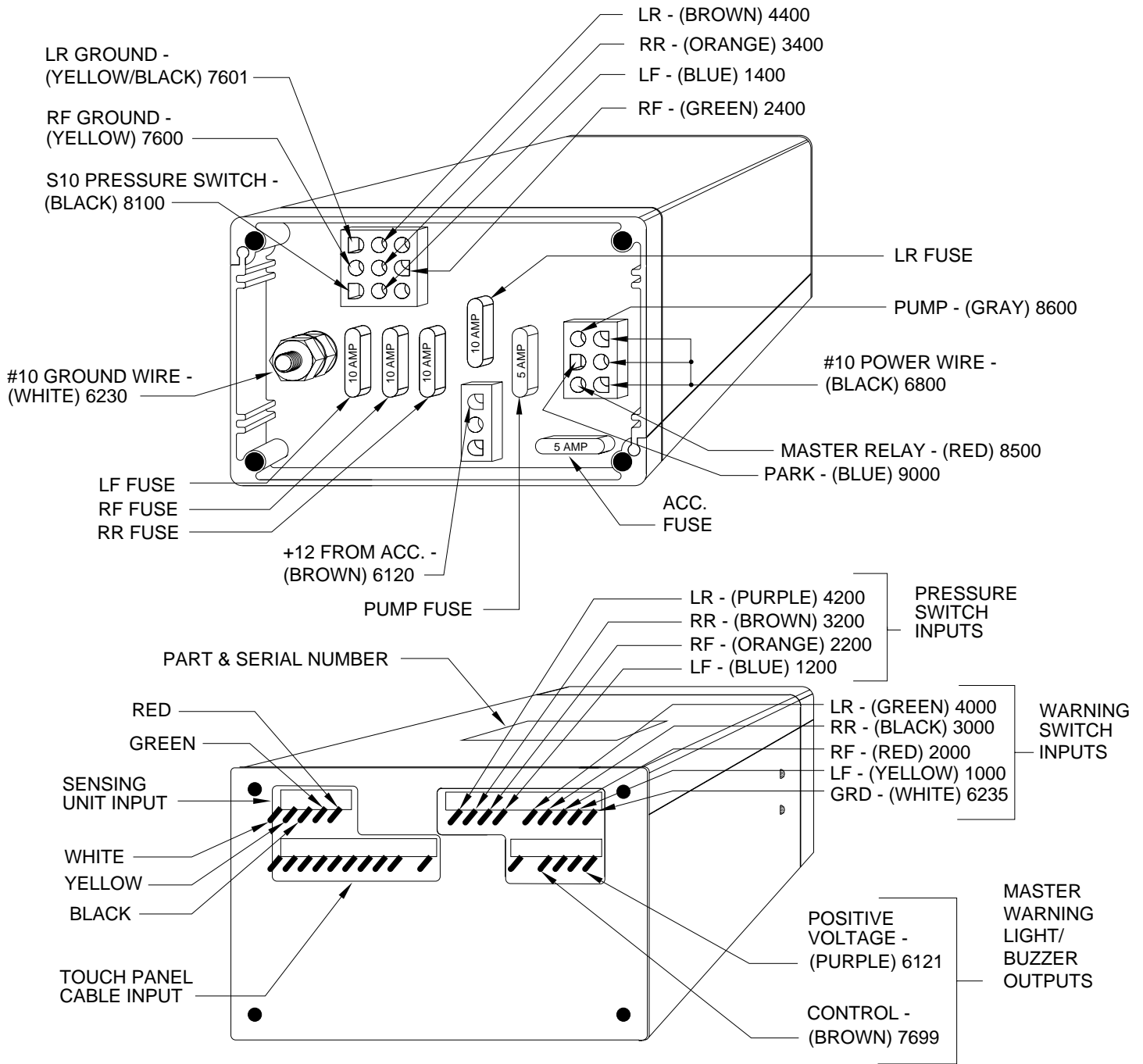

NOTE: THE (4) DIGIT WIRE NUMBER SUPERSEDES ANY AND ALL WIRE COLORS

ELECTRICAL CONNECTION DIAGRAM 610 SERIES LEVELING SYSTEMS

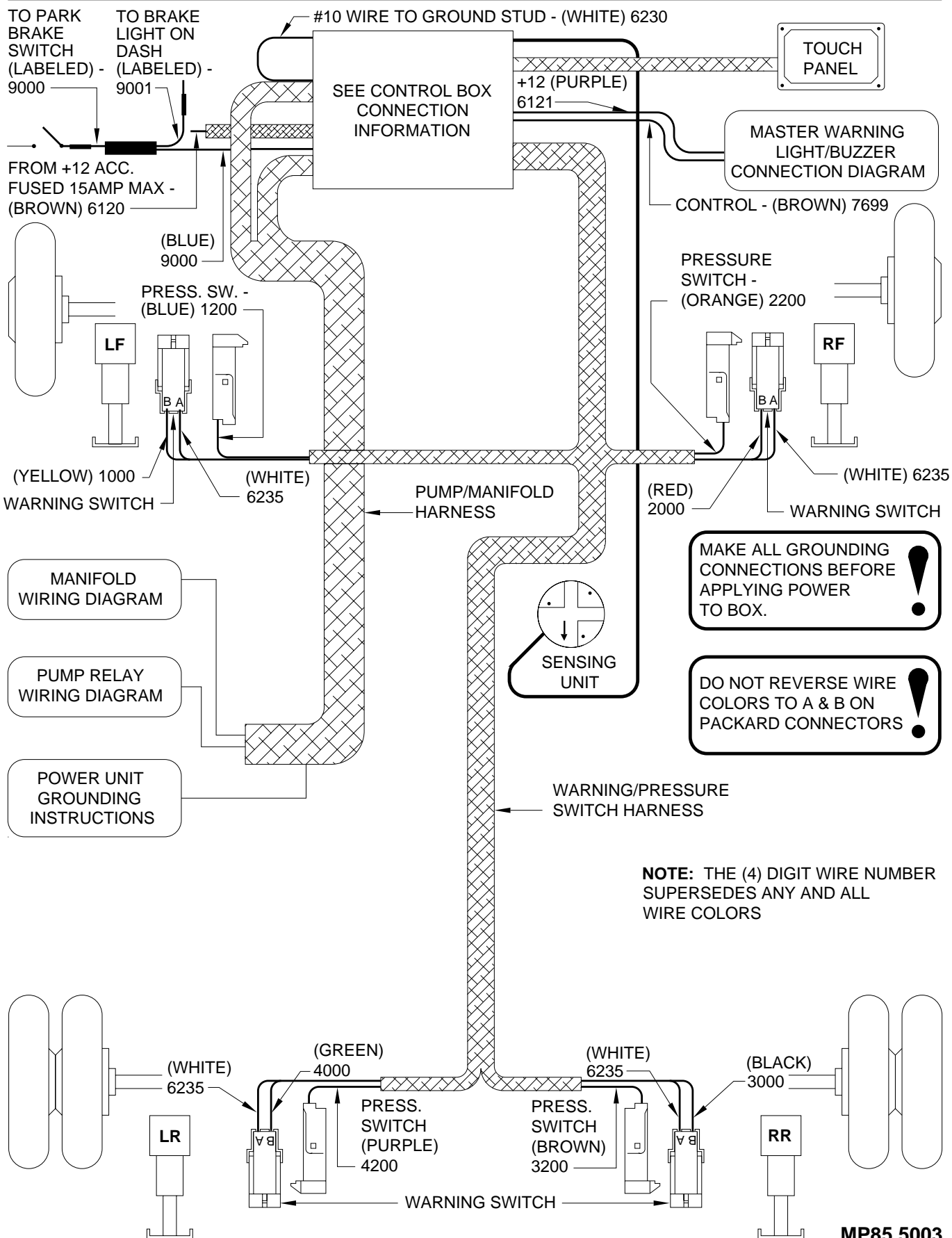

CONNECTION INFORMATION 610 SERIES LEVELING SYSTEMS WITH AIR DUMP

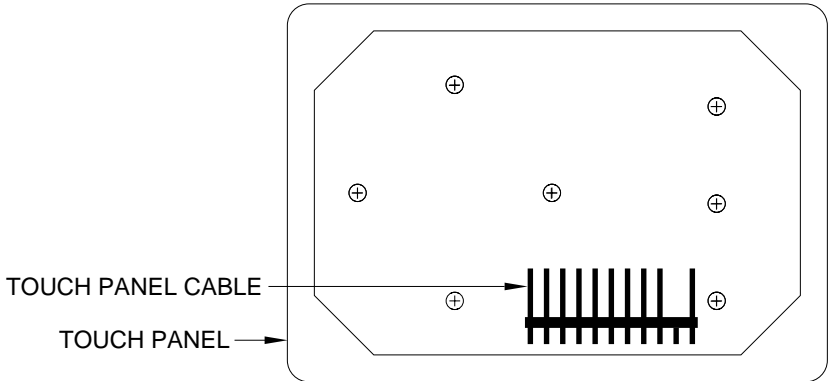
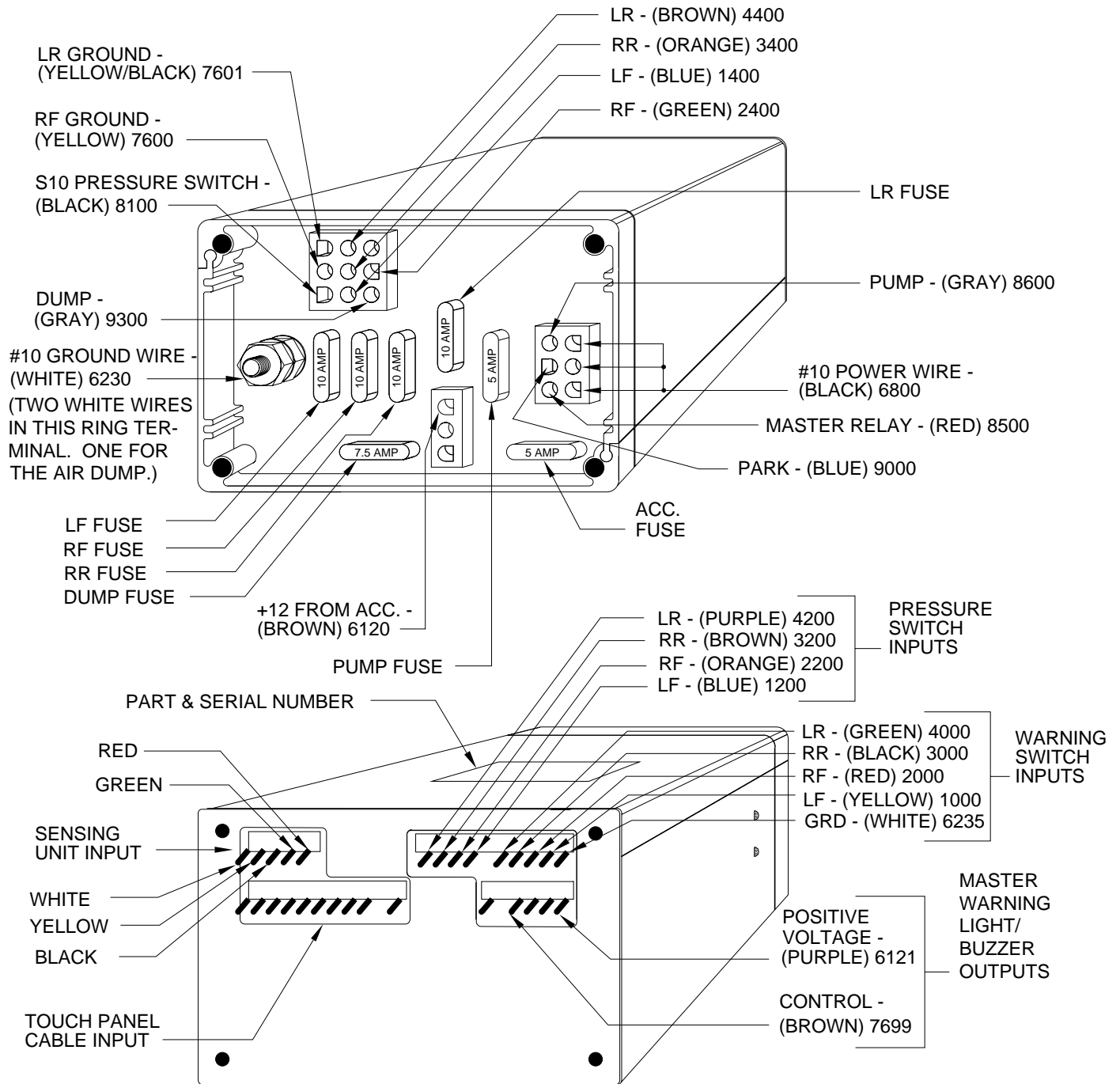

NOTE: THE (4) DIGIT WIRE NUMBER SUPERSEDES ANY AND ALL WIRE COLORS

MASTER AND PUMP RELAY WIRING DIAGRAM FOR 610 SERIES LEVELING SYSTEMS

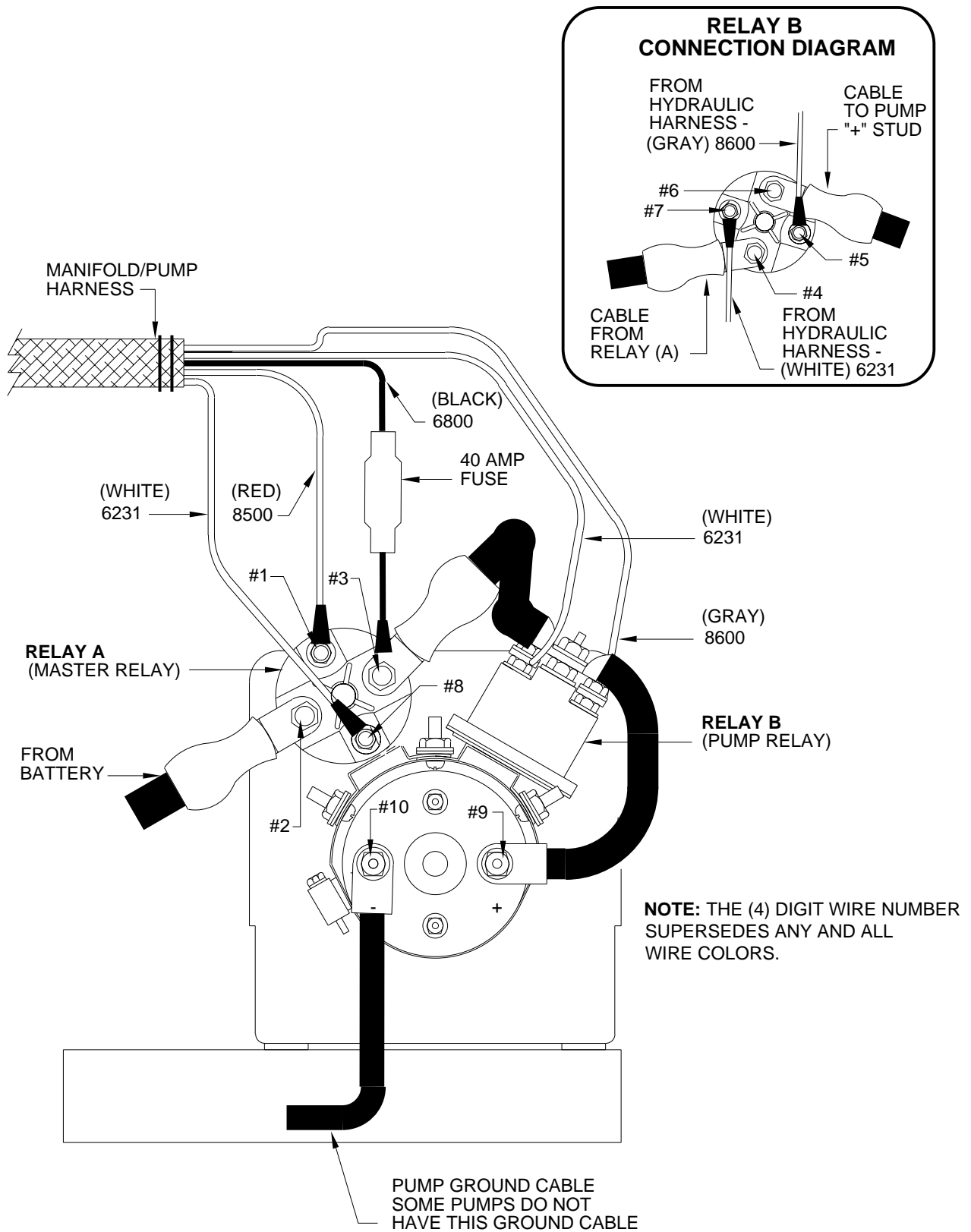

ELECTRICAL CONNECTION DIAGRAM 610 SERIES LEVELING SYSTEMS WITH AIR DUMP

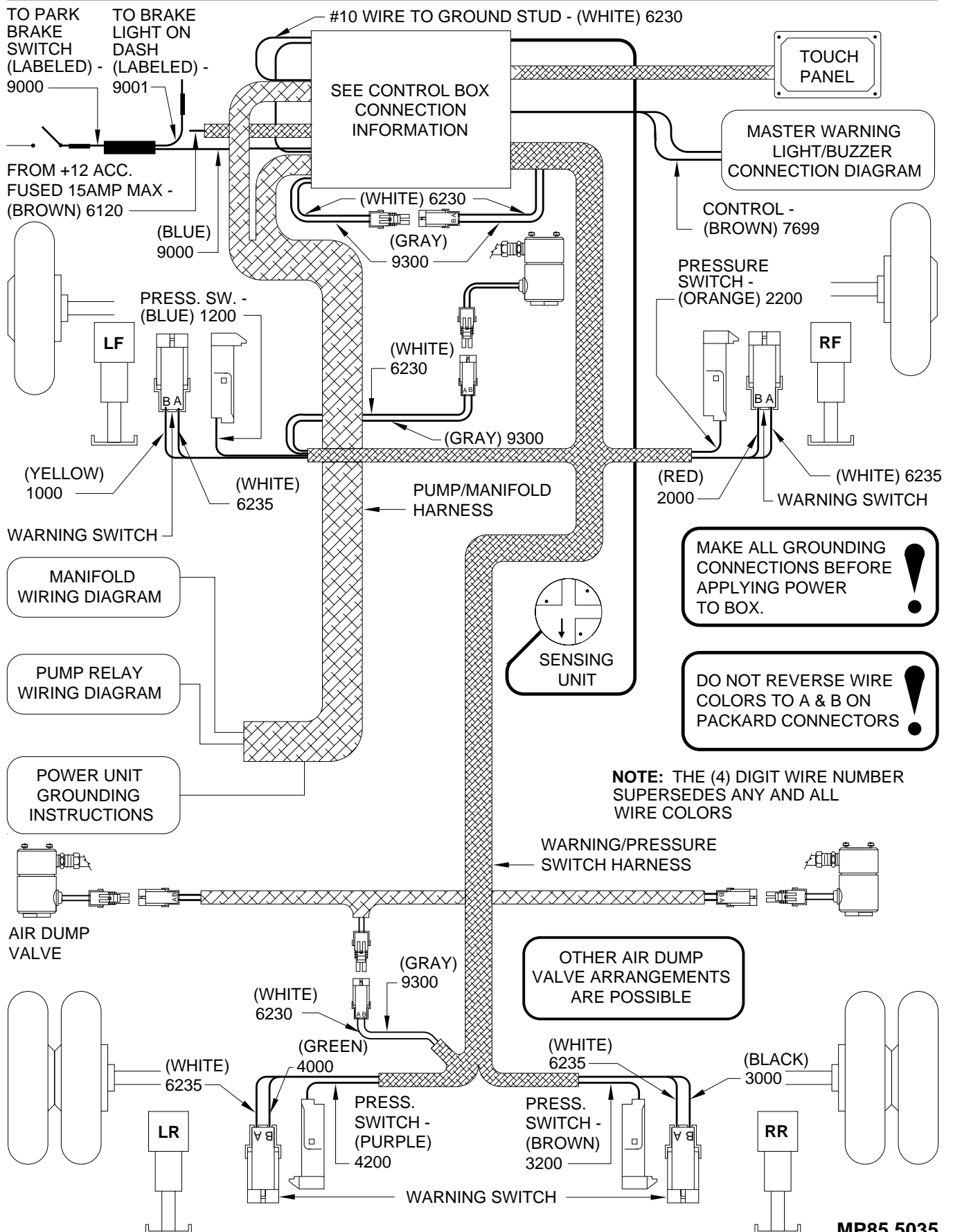

WIRING DIAGRAM MANIFOLD FOR 610 SERIES LEVELING SYSTEMS

NOTE: ROOM EXTENSION MANIFOLD NOT SHOWN.

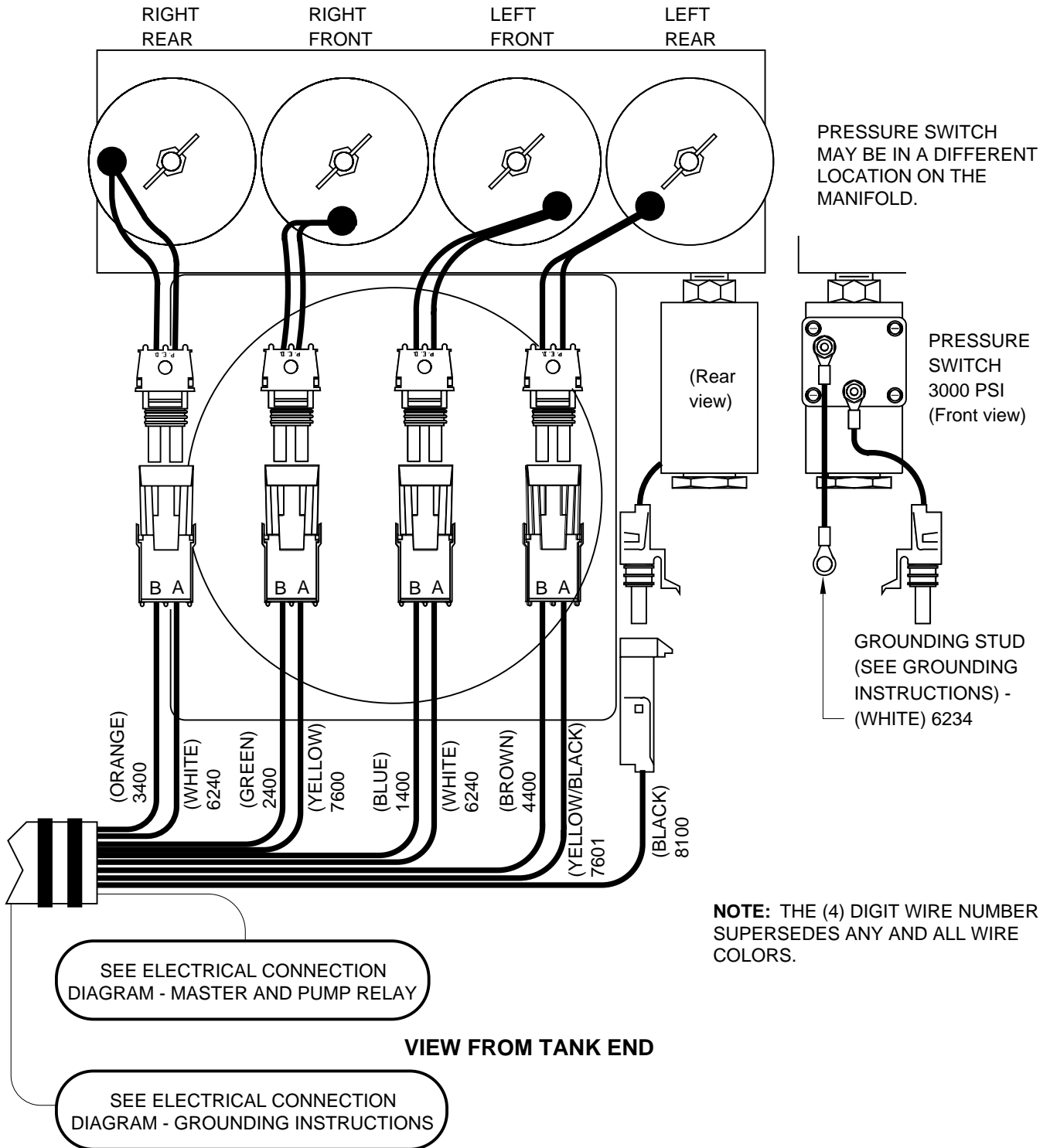

ELECTRICAL CONNECTION DIAGRAM POWER UNIT/HARNESS GROUNDING INSTRUCTIONS 610 SERIES LEVELING SYSTEMS

WELDED PUMP MOUNT

Use grounding stud and 3/8" internal star lockwashers as shown.

IMPORTANT: STAR LOCKWASHER MUST BE USED BETWEEN GROUNDING SURFACE AND WIRE TERMINALS

NOTE: THE (4) DIGIT WIRE NUMBER SUPERSEDES ANY AND ALL WIRE COLORS.

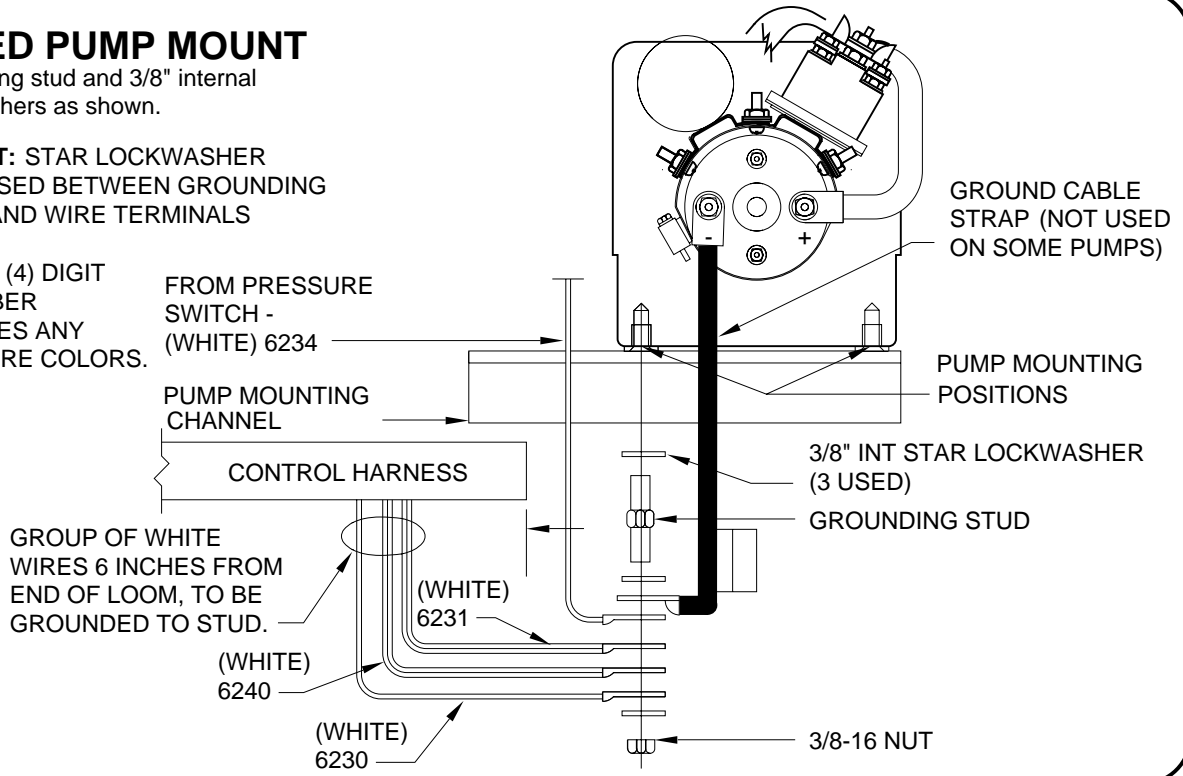

PUMP MOUNTED REMOTE FROM FRAME

Use grounding stud and 3/8" internal star lockwashers as shown.

IMPORTANT: STAR LOCKWASHER MUST BE USED BETWEEN GROUNDING SURFACE AND WIRE TERMINALS

NOTE: THE (4) DIGIT WIRE NUMBER SUPERSEDES ANY AND ALL WIRE COLORS.

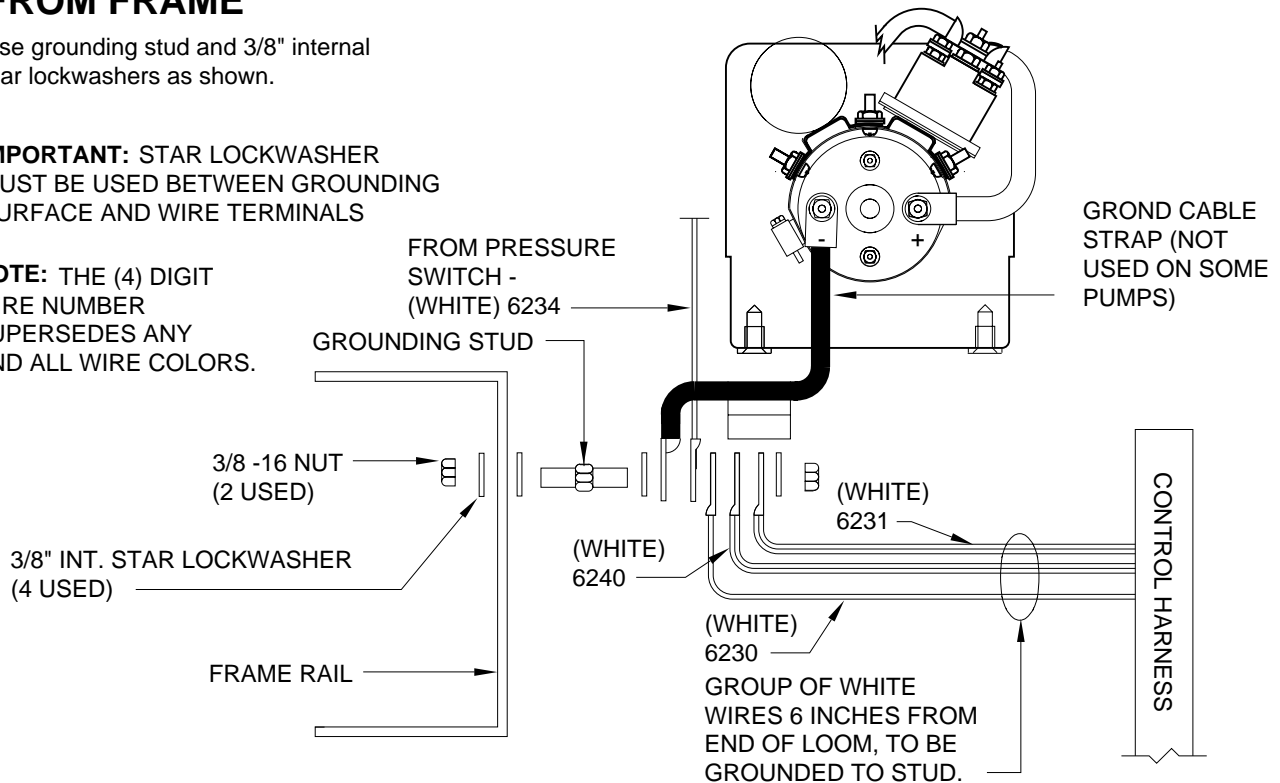

MASTER LIGHT/BUZZER CONNECTION DIAGRAM COMPUTER-CONTROLLED 610 SERIES LEVELING SYSTEMS

A MASTER WARNING INDICATOR SHOULD ALWAYS BE USED. WHEN THE LEVELING SYSTEM HAS STRAIGHT ACTING JACKS A WARNING BUZZER MUST BE USED.

WHEN ONLY A RED MASTER WARNING LIGHT IS USED THE 12+ POWER FOR THE LIGHT COMES THROUGH THE CONTROL PANEL. (SEE FIGURE 1 BELOW). WHEN BOTH A RED LIGHT AND WARNING BUZZER ARE USED THE +12 POWER FOR BOTH INDICATORS IS SUPPLIED BY THE IGNITION SWITCH. THE POWER MUST COME FROM THE "ON" SIDE OF THE IGNITION SWITCH, NOT THE "ACC" SIDE. (SEE FIGURE 2 BELOW)

NOTE : BY SUPPLYING IGNITION POWER TO THE WARNING BUZZER AND LIGHT, AND "ACC" POWER TO THE CONTROL PANEL, THE SYSTEM MAY BE OPERATED IN ACCESSORY WITHOUT THE BUZZER SOUNDING. THE NEGATIVE SIGNAL FOR THE WARNING INDICATORS MUST ALWAYS COME FROM THE CONTROL BOX.

CAUTION: THE (PURPLE) 6121 WIRE IN THE MASTER WARNING LIGHT HARNESS IS HOT WHENEVER THE IGNITION IS "ON" OR "ACC". THE (PURPLE) 6121 WIRE MUST BE REMOVED FROM THE HARNESS WHEN USING DIRECT IGNITION VOLTAGE FOR THE MASTER WARNING INDICATORS.

NOTE : THE (4) DIGIT WIRE NUMBER SUPERSEDES ANY AND ALL WIRE COLORS.

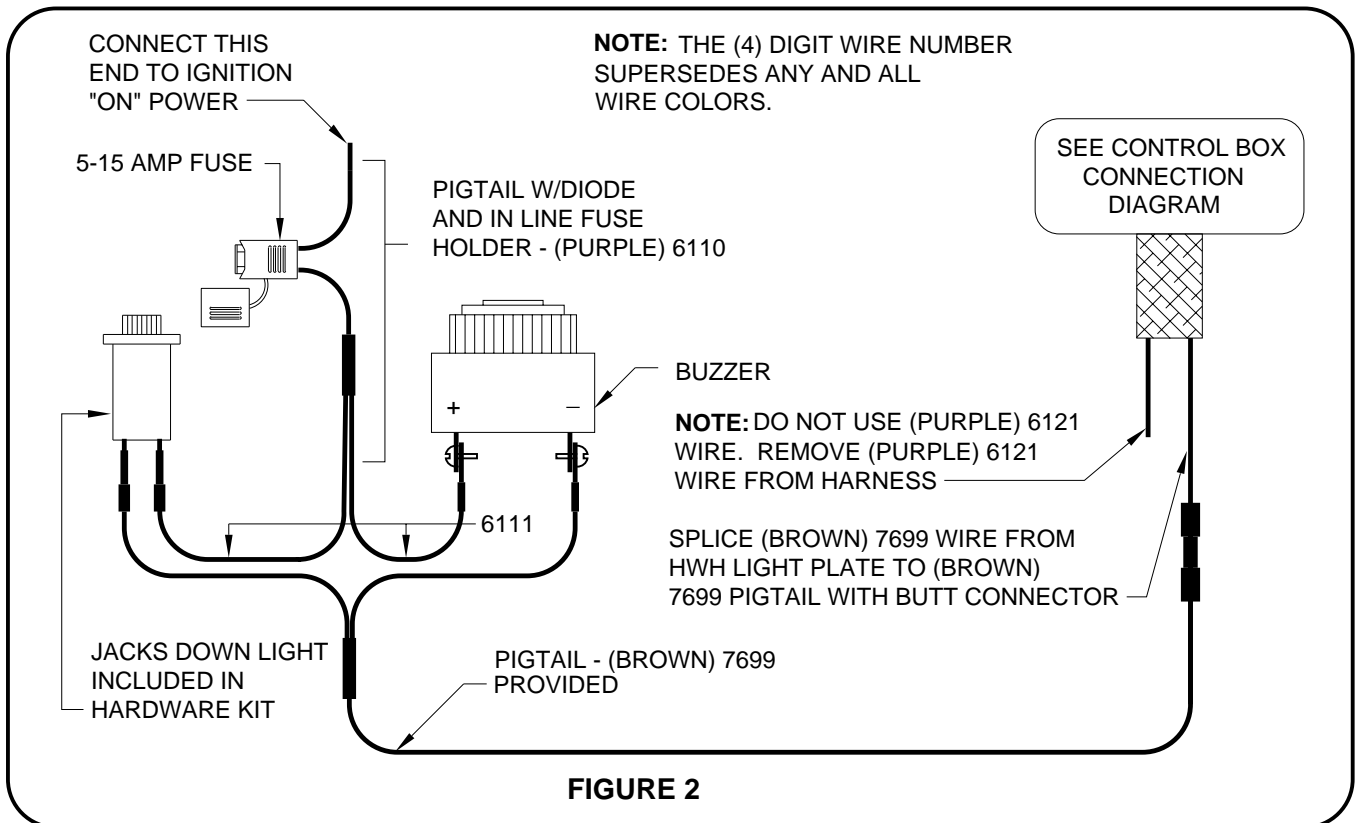
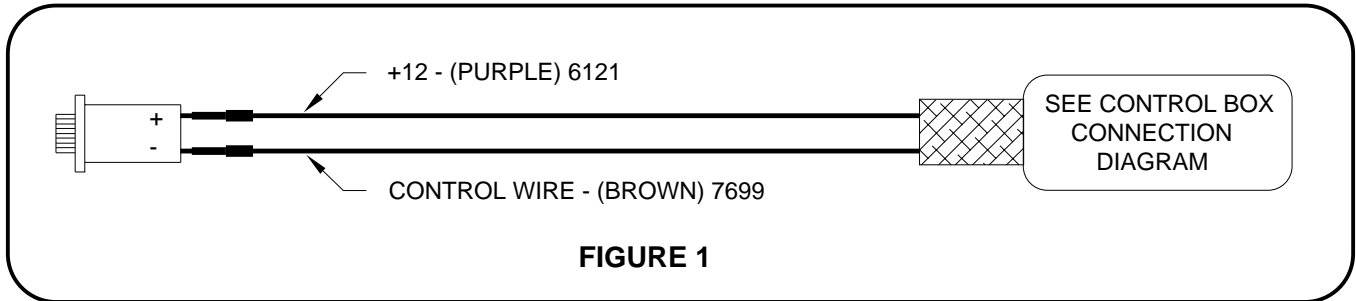

**6000# CAPACITY JACK WITH PRESSURE SWITCH
FOR 610 SERIES LEVELING SYSTEMS
2-WIRE WARNING SWITCH**

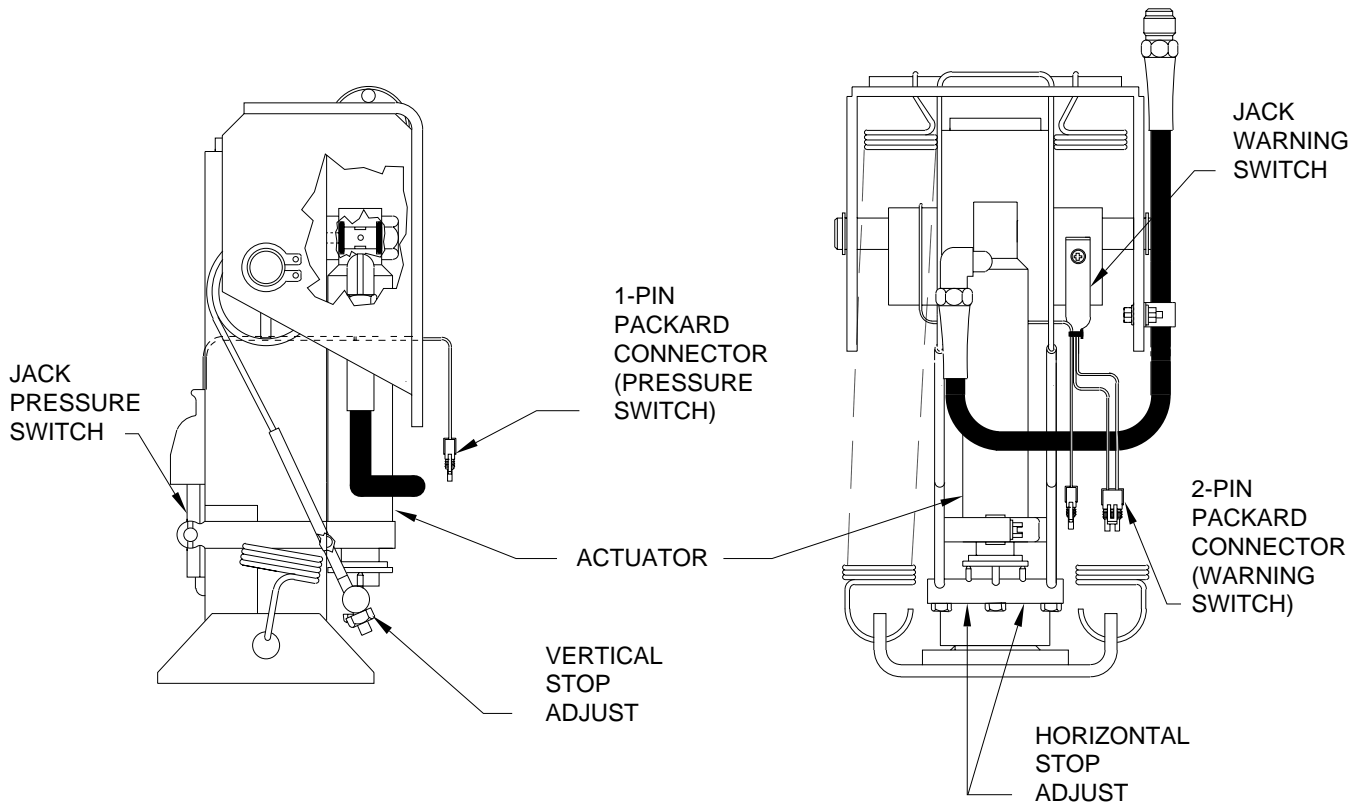

**9000# CAPACITY JACK WITH PRESSURE SWITCH
FOR 610 SERIES LEVELING SYSTEMS
2-WIRE WARNING SWITCH**

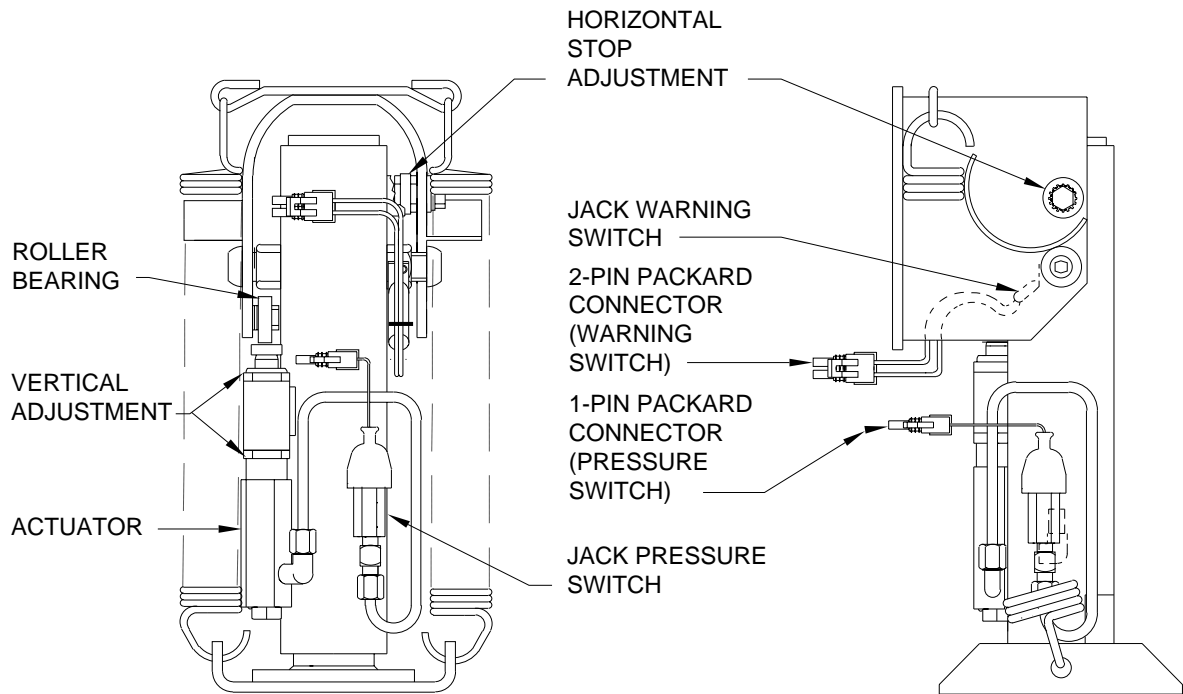

**16,000# CAPACITY JACK WITH PRESSURE SWITCH
FOR 610 SERIES LEVELING SYSTEMS
2-WIRE WARNING SWITCH**

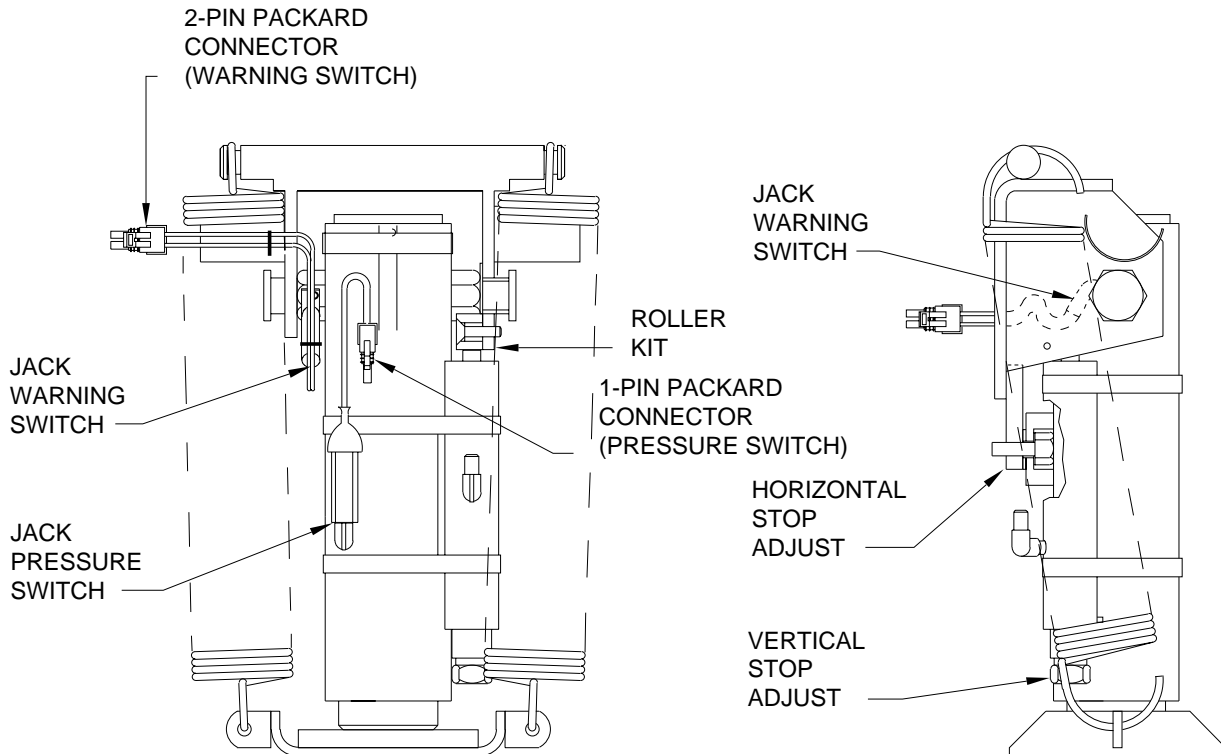

**PRESSURE SWITCH
ADJUSTMENT COMPONENT IDENTIFICATION**

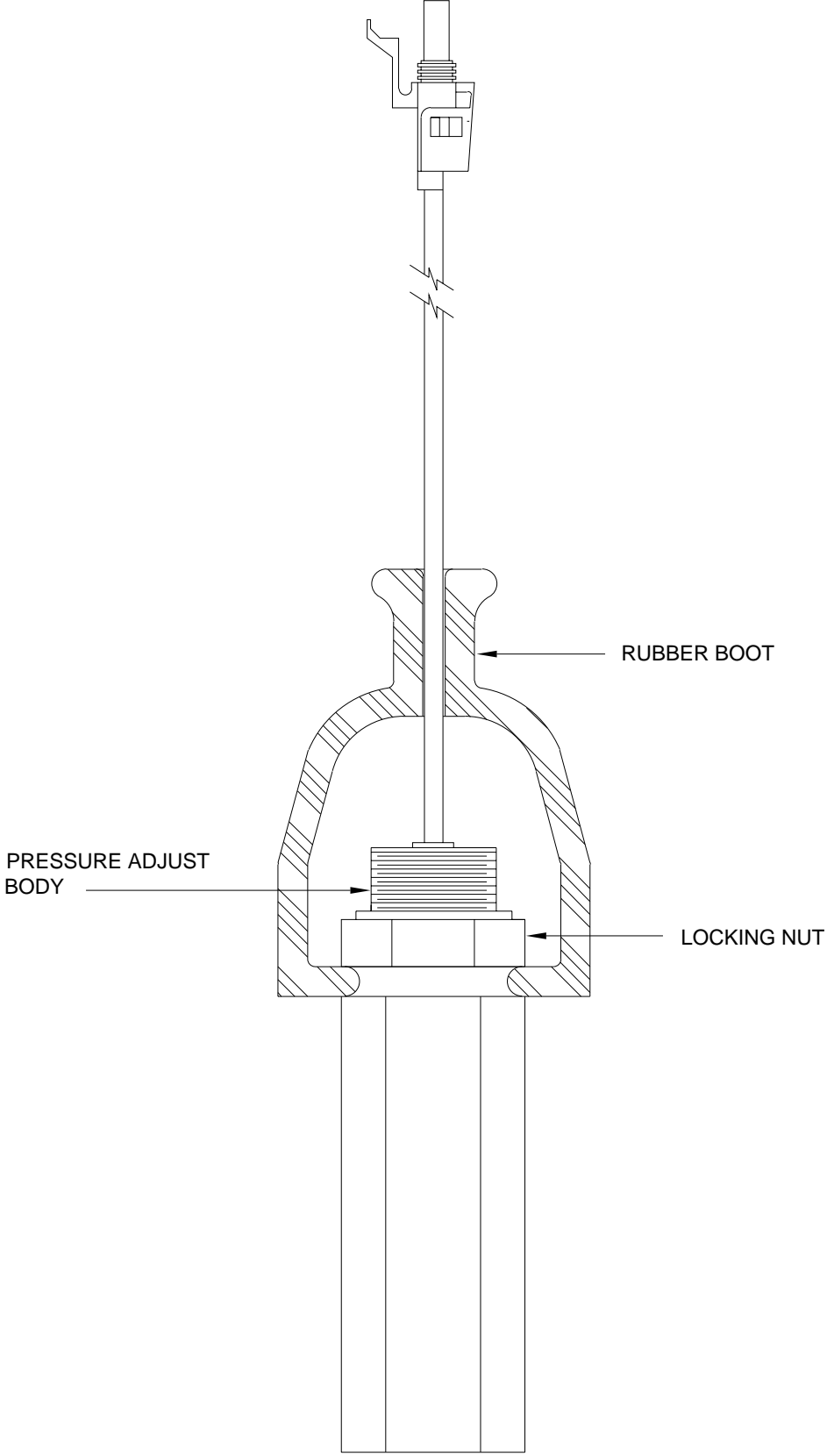

MOUNTING AND ADJUSTMENT INSTRUCTIONS

LEVEL SENSING UNIT

The sensing unit must be mounted to a solid surface and must not be exposed to any heat sources. Toward the middle of the vehicle but outside the frame rails is best. The sensing unit may be mounted between frame rails on pusher vehicles and trailers. The sensing unit may be mounted in a compartment but needs to be protected from stored objects. It is critical that the sensing unit is mounted in the proper position according to the sticker on the sensing unit. (See figure below). The springs should be compressed to approximately 1.25 inches.

The correct method for adjusting the sensor is as follows:

First, level the vehicle by placing a 24" level in the center of the vehicle on the floor. With the vehicle level adjust the sensing unit until all yellow lights are out. This is done by drawing up or backing out the sensing unit screws. If a front light is on, adjust the front screw. If a side light is on adjust the side screw. If a rear light is on adjust the rear screws. One or more screws may have to be adjusted to turn the yellow lights out. After adjustment has been made, pull down on the sensing unit to make sure the unit is bottomed out on the screw heads. Check to make sure all yellow lights are out. If not, readjust. Rock the vehicle and recheck for yellow lights, readjust if needed.

NOTE: The sensing unit has an accuracy tolerance of +/- 1" side to side and +/- 5.4" front to rear on a 36' vehicle.

