

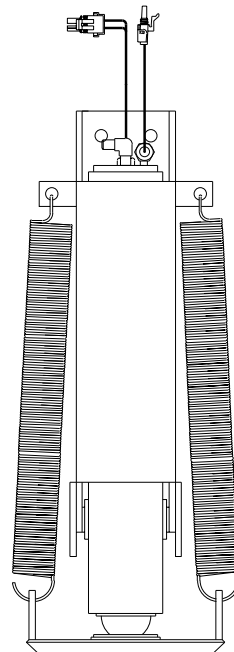

# REPAIR MANUAL

## HWH COMPUTER-CONTROLLED LEVELING SYSTEM 610 SERIES

FEATURING:  
**TOUCH PANEL CONTROL**  
**SINGLE HOSE**  
**CENTRAL GROUNDING**  
**STRAIGHT-ACTING JACKS**  
**STANDARD TWO WIRE WARNING SWITCHES**

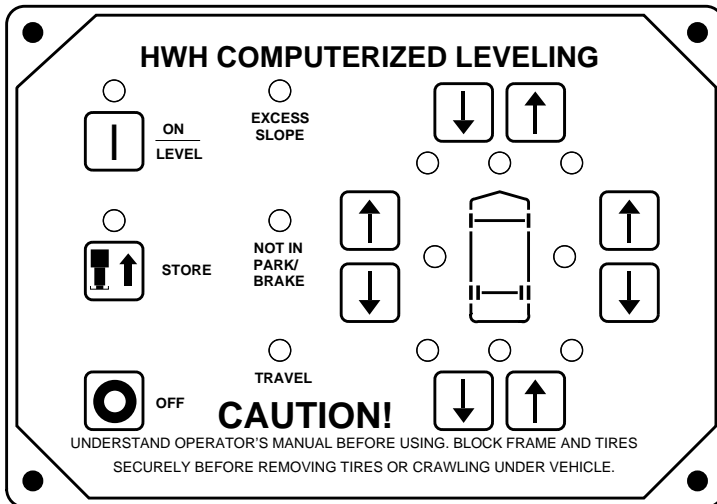

**HWH CORPORATION**  
**(ON I-80, EXIT 267 SOUTH)**  
**2096 MOSCOW ROAD**  
**MOSCOW, IOWA 52760**  
**(800) 321-3494 / (563) 724-3396**  
**INTERNET: <http://www.hwhcorp.com>**

ML1681/MI91.0002  
18JUN01

# SECTION 1

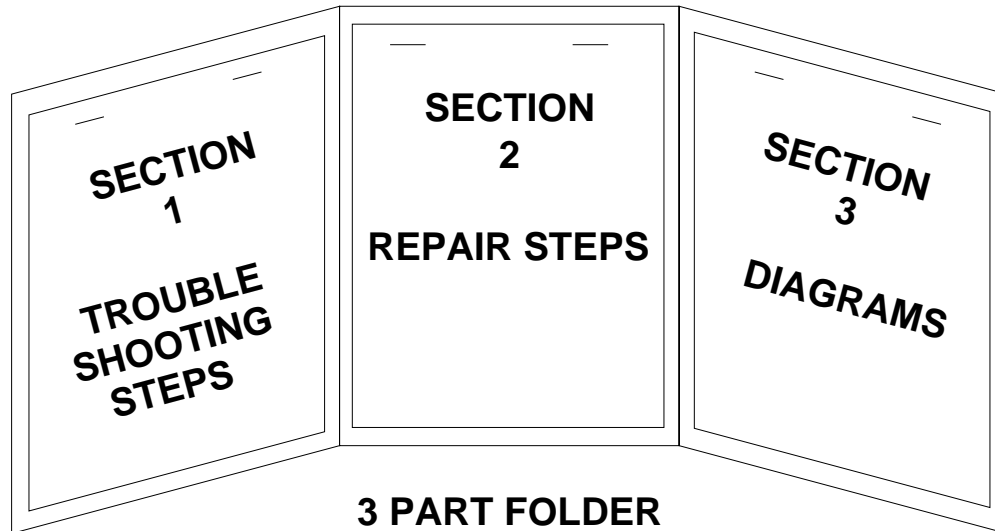

## HOW TO USE MANUAL

This manual is written in three sections. Section 1 is the Trouble Shooting Steps. Section 2 is the Repair Steps. Section 3 is the Diagrams. Begin diagnosis of the system with Section 1, the Trouble Shooting Steps. This will give the correct operation and function of the system. When a malfunction is encountered, the Trouble Shooting Steps will direct you to the proper Repair Steps in Section 2, the Repair Steps. The Repair Steps are broken into 3 columns, Problem, Solution, and Diagram. In the proper part under Problems, find the symptom you have encountered. The testing and repair for that problem is in the Solution (center) column. Diagrams for a particular Problem and Solution are in the Diagram (right hand) column. This column will direct you to the proper diagram in Section 3, Diagrams, for a more detailed view.

Before beginning your repair, it is **IMPORTANT** to read the **CAUTIONS** and **NOTES AND CHECKS** in the first section, **TROUBLE SHOOTING STEPS**. In many cases this will save time and mistakes when trouble shooting a system.

This Repair Manual is offered as a guide only. It is impossible to anticipate every problem or combination of problems. This manual is written in sequential order of the proper operation of the system. The Trouble Shooting Steps must be followed in order to give correct diagnosis of the problem(s). For any problems encountered that are not addressed in this manual, contact HWH Corporation for assistance.

**NOTE: Diagrams in this manual are of typical systems. There may be plumbing or harness differences. In most cases this should not effect trouble shooting procedures.**

**PROCEED WITH TROUBLE SHOOTING GUIDE**



# TROUBLE SHOOTING

## CAUTIONS!

**BLOCK FRAME AND TIRES SECURELY BEFORE CRAWLING UNDER VEHICLE. DO NOT USE THE LEVELING JACKS OR AIR SUSPENSION TO SUPPORT VEHICLE WHILE UNDER VEHICLE OR CHANGING TIRES. VEHICLE MAY DROP AND OR MOVE FORWARD OR BACKWARD WITHOUT WARNING CAUSING INJURY OR DEATH.**

**WHEN ROUTING OR REROUTING HYDRAULIC HOSES AND WIRES, BE SURE THEY ARE NOT EXPOSED TO ENGINE EXHAUST OR ANY HIGH TEMPERATURE COMPONENTS OF THE VEHICLE.**

**THE JACKS MAY ABRUPTLY SWING UP WHEN THE FOOT CLEARS THE GROUND OR WHEN THE JACK REACHES FULL EXTENSION.**

**NEVER PLACE HAND OR OTHER PARTS OF THE BODY NEAR HYDRAULIC LEAKS. OIL MAY CUT AND PENETRATE THE SKIN CAUSING INJURY OR DEATH.**

**SAFETY GLASSES ARE TO BE WORN TO PROTECT EYES FROM DIRT, METAL CHIPS, OIL LEAKS, ECT. FOLLOW ALL OTHER SHOP SAFETY PRACTICES.**

**DO NOT OVER EXTEND THE REAR JACKS. IF THE WEIGHT OF THE VEHICLE IS REMOVED FROM ONE OR BOTH REAR WHEELS, THE VEHICLE MAY ROLL FORWARD OR BACKWARD OFF THE JACKS.**

## NOTES AND CHECKS

**Read and check before proceeding with Trouble Shooting Steps.**

**NOTE: HWH CORPORATION ASSUMES NO LIABILITY FOR DAMAGES OR INJURIES RESULTING FROM THE INSTALLATION OR REPAIR OF THIS PRODUCT.**

1. If the jacks cannot be retracted, see TROUBLE SHOOTING Step 10 for temporary measures. Make sure the manual retract valves are closed before trouble shooting.

2. The Trouble Shooting Guide must be followed in order. Problems checked for in one step are assumed correct and not checked again in following steps.

3. Check that the oil reservoir is full with the jacks in the fully retracted position.

4. Most coaches have more than one battery; one for the engine and the other(s) for the coach. The engine battery supplies power for the control box and hydraulic pump. DO NOT use the coach batteries to supply power to the pump. Batteries under no load should read 12.6 volts. Batteries must maintain good voltage under load. Batteries must be in good condition with no weak cells. The system will draw up to 200 amps. An alternator, convertor or battery charger will not supply enough power for the system to operate properly.

5. The control box monitors the engine battery during the "AUTOMATIC LEVELING and RETRACT" modes of operation. The battery symbol on the touch panel will be lit when battery voltage drops below 8.5 - 9.0 volts, but the system will continue to function. Have the batteries properly charged to their full capacity.

6. Proper grounding of all components is critical. See the electrical circuit for specific grounds required. Faulty grounds, especially for the control box, solenoid manifold or the pump assembly, may cause control box component damage and /or improper or erratic operation.

7. Do not replace the control box unless the repair steps say to replace it. Otherwise the malfunctions may damage the new control box.

**This manual is intended for use by experienced mechanics with knowledge of hydraulic and automotive electrical systems. People with little or no experience with HWH leveling systems should contact HWH technical service (800-321-3494) before beginning. Special attention should be given to all cautions, wiring, and hydraulic diagrams.**

**Special note: When installing a new control box, make sure the box is properly grounded before applying power to the system.**

**Tightening of hose ends: If tightening a new hose end, make the hose end snug (finger tight) on the fitting, then tighten the hose end 1/3 turn (2 FLATS). If tightening an existing hose end, tighten the hose end to snug plus 1/4 turn (1 FLAT).**

Suggested tools for trouble shooting the HWH leveling systems:  
JUMPER WIRES(UP TO 10 GAUGE)  
PRESSURE GAGE(3500 PSI MIN.)  
MULTI-METER  
12 VOLT TEST LIGHT

**PROCEED WITH THE TROUBLE SHOOTING STEPS ON THE FOLLOWING PAGE**



**MI91.1020  
18JUN01**

# TROUBLE SHOOTING STEPS

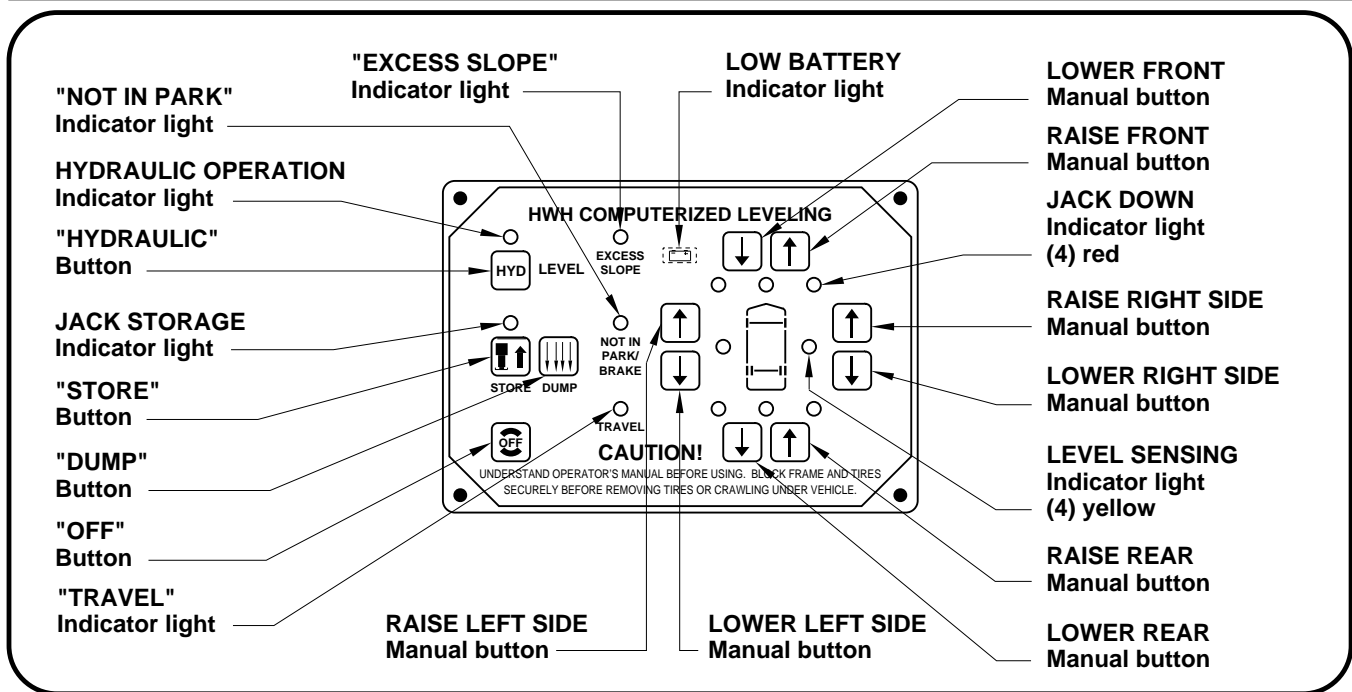

1. Make sure the transmission is in the recommended position for parking and the park brake is set. With the ignition switch off, there should be no power to the leveling system. If any touch panel lights are on, see Part 1 of the Repair Steps.

2. Turn the ignition switch to "ACC". Only the green travel lights should be lit at this time. If this is not so, see Part 2 of the Repair Steps.

3. Push the "I" (HYD) button one time. The red indicator light above the "I" (HYD) button should glow steady. One or two yellow level indicator lights may be on. The green travel light will still be on. The "NOT IN PARK/BRAKE" light should NOT be lit. The pump should not run. If this is not so, see Part 3 of the Repair Steps.

4. After pushing the "I" (HYD) button one time, the operator can manually operate the jacks with the eight buttons (arrows) on the right half of the touch panel. The up arrow will lift the vehicle by extending the jacks; whereas, the down arrows will lower the vehicle by retracting the jacks. The jacks operate in pairs; left side, right side, front or rear. Press the up arrow button for each jack pair, checking the proper pair of jacks operate. Press the down arrows to make sure the jacks will retract properly. If any of these functions do not work properly, see Part 4 of the Repair Steps.

**NOTE:** If the **LOW BATTERY** light comes on it will not interfere with the operation of the system, but battery voltage and connections should be checked.

5. Air dump test for vehicles with air dump option. The air dump button will work either with the leveling system off and the ignition on, or with the leveling system on. There should be one air dump valve for each height control valve. The air dump valves may be equipped with emergency shutoff valves make sure they are open. With the system off and the

ignition on and the engine running, push the dump button. The air should dump from the suspension while the dump button is being pushed. When the dump button is released, the air should stop dumping and the vehicle should return to proper ride height. Again with the engine running, push the "I" (HYD) button. The air dump button should work at this time. Air will dump from the system when the button is depressed and stop dumping when released. The vehicle should return to the proper ride height. If this does not function properly, see Part 5 of the Repair Steps section.

6. Sensing unit check. If the vehicle is equipped with air dump, dump the air at this time. Using a bubble level the inside of the vehicle, level the vehicle using the button on the right side of the panel as described in Part 4 above. All yellow lights should be off at this time. If not, the sensing unit may need to be adjusted.

When a yellow light is on it indicates that side or end of the vehicle is low according to the sensing unit. Check also that all lights can be made to come on (at different times) by extending or retracting jacks. If the ground is sloping or uneven, the vehicle may need to be moved to complete the test. For sensor adjustment procedures or diagnostic procedures, see Part 6 of the Repair Steps.

**At this time, manually retract all jacks to their fully stored position. From this point on, it is assumed the system is fully functional in the manual mode. Whenever a malfunction occurs, revert to the manual operation and check for correct functioning. If a problem is found in the manual operation, trouble shoot the problem using the preceding steps. Remember, low volts can cause erratic operation and damage components.**

---

# TROUBLE SHOOTING STEPS

## CONTINUED

---

### AUTOMATIC LEVELING

7. Turn the ignition switch to the "ACC" position. For vehicles with automatic air dump, the engine must be off during leveling. Press the "I" (HYD) button. The red indicator light above the "I" (HYD) button will be lit. Set the park brake if the "NOT IN PARK/BRAKE" light is on. Press the "I" (HYD) button a second time. This will start the automatic leveling process. The following should occur:

a. The red indicator light above the "I" (HYD) button will start to flash.

b. Vehicles equipped with automatic air dump will dump the air at this time. The system will dump air for approximately 45 seconds before continuing. The dump valves will remain open until the leveling system has automatically shut itself off.

c. Two jacks at a time will extend corresponding to any yellow light(s) which is/are lit. This will continue until all yellow level light(s) are out or until one or two jacks have reached their full extension. If the excess slope light comes on, the system will not stabilize. The panel will stay on for 2 minutes, then shut off. (Older systems will shut off after 10 seconds.)

d. The red light "JACKS DOWN" indicator lights will come on for each jack when the jack is extended 2 or more inches.

e. After a pause, the pump will come on and run until all remaining jacks not touching the ground, extend to the ground to stabilize the vehicle. Through a pressure switch on each jack, the control box automatically senses when each jack is firmly on the ground. The computer constantly rechecks all the jack pressure switches and will return to any jack that has lost its pressure switch signal until all four jacks have reached the minimum stabilize pressure. If either front jack pressure switch is off, both front jacks will stabilize. Jacks used to stabilize the vehicle should lift the coach a minimum of 1/2 inch.

f. The red indicator light above the "I" (HYD) button will stop flashing, the red indicator light will go out as the system shuts off. If any of the above does not function properly, see Part 7 of the REPAIR STEPS.

**"EXCESS SLOPE":** The "EXCESS SLOPE" light will only come on in the automatic leveling mode. If there is a problem with the "EXCESS SLOPE" light, refer to Part 7C of the REPAIR STEPS. The "EXCESS SLOPE" light will come on during stabilize if the pump does not shut off and the manifold pressure switch is tripped.

### RETRACT PROCEDURE

8. For systems with automatic air dump, start the vehicle engine to build up the air pressure and leave it running. If the dump valves are not closed, see Part 6 of this section.

9. Push the "I" (HYD) button one time. The red indicator light above the "I" (HYD) button will glow steady. The pump should NOT be running. Push "STORE" button. The following should occur:

a. The red indicator light above the "STORE" button should start to flash.

b. The jacks should retract to the store position. The front jacks will retract for 5 seconds before the rear jacks start to retract.

c. The red warning lights on the touch panel should go out when the jacks are extended less than 2 inches.

d. The master warning light should go out.

e. The green "TRAVEL" light should come on.

f. The red indicator light above the "STORE" button will stop flashing and the computer will automatically shut off. The only light that should be lit on the touch panel will be the "TRAVEL" light. If any of the above does not occur, see Part 8 of the Repair Steps.

**NOTE:** The system will automatically retract for 6 minutes after all red warning lights are out, unless 1 or more red warning lights stay lit. If a warning light stays lit, the system will continue to retract for 30 minutes and then shut down regardless of any lit warning lights.

**CAUTION: UNLESS TROUBLE SHOOTING, THE LEVELING SYSTEM MUST BE ALLOWED TO RETRACT THE FULL 6 MINUTES BEFORE INTERRUPTING POWER TO THE COMPUTER.**

**10. EMERGENCY JACK RETRACTION:** Each solenoid valve is equipped with a "T" handle release valve. Turn the handle counter clockwise approximately 3 turns or until the jacks start to retract. The oil will return to the reservoir and the jack should retract. After all the jacks are fully retracted, turn the "T" handles clockwise until snug. If no jacks retract, close all "T" handles and make sure the Touch Panel is OFF. Remove then reassemble any one check valve cap. (SEE MP65.0) The system should then store. If not, contact HWH Customer Service for assistance. See Part 9 of the REPAIR STEPS.

# REPAIR STEPS

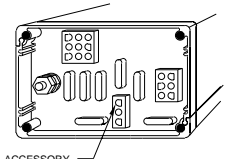
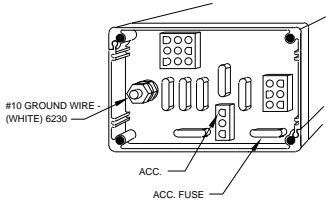
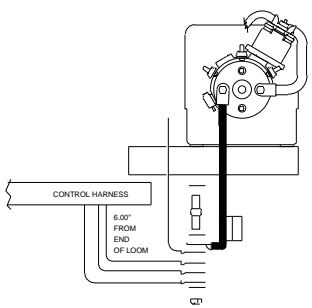
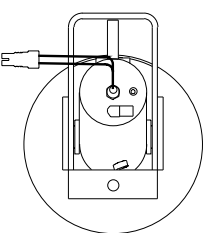
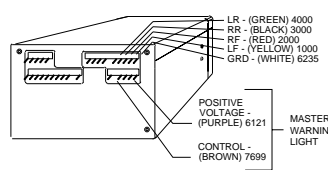
PROBLEM	SOLUTION	FIGURES
<p><b>Part 1</b>  <b>Touch panel has indicator lights on with the ignition switch off.</b></p>	<p>There should be no +12 power to the 8" control box. Trace the (BROWN) 6120 wire in the 3 pin UML connector to its source. The wire should be connected to accessory power.</p>	 <p style="text-align: center;"><b>REFER TO MP85.5005</b></p>
<p><b>Part 2</b>  <b>With the ignition switch on:</b></p> <p>a. The green "TRAVEL" light nor the master "JACKS DOWN" warning light is lit.</p>	<p>With the ignition switch on, the (BROWN) 6120 wire in the 3 pin UML connector should have +12 power. If not, trace the wire to its source. Check any inline fuses. If +12 power is present, check the 5 amp "ACC" fuse on the 8" control box. Check that the 10 guage (WHITE) 6230 wire is properly grounded to the frame. If it is okay, the problem is most likely in the 8" control box. but it could be in the touch panel, or the moduler cable.</p>	 <p style="text-align: center;"><b>REFER TO MP85.5005</b></p>  <p style="text-align: center;"><b>REFER TO MP85.5045</b></p>
<p>b. The master "JACKS DOWN" warning light is on. (Jacks are all in the stored position)</p>	<p>Push the "I" (HYD) button one time. A red jacks down warning light on the touch panel should come on, indicating a jack is down. If a light comes on, unplug the jack warning switch for that light. If the light goes out, replace the warning switch. If not, unplug the 9 wire MTA connector for warning switches at the 8" control box. If the red warning light goes out, the wire to the jack warning switch is shorted to ground. If the red warning light stays on, replace the 8" control box.</p> <p>If no red warning light on the touch panel comes on, check the wires to the master warning light. If the wires are okay, replace the 8" control box.</p>	 <p style="text-align: center;"><b>REFER TO MP85.5010</b></p>  <p style="text-align: center;"><b>REFER TO MP85.5001</b></p>

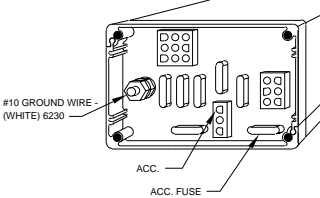
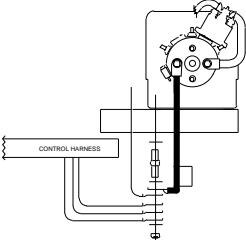
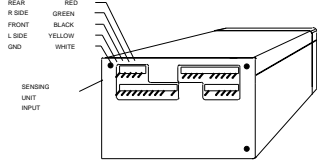
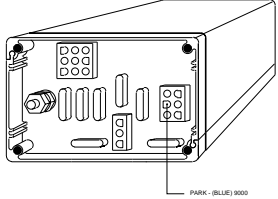
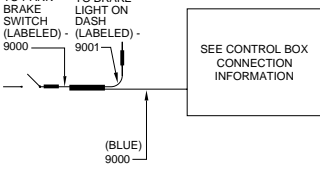
PROBLEM	SOLUTION	FIGURES
<p><b>Part 2 Continued</b></p> <p>c. The touch panel has indicator lights on other than the green "TRAVEL" indicator.</p>	<p>Turn the ignition switch off then back on. If the lights do not go out, the problem is most likely the 8" control box, but it could be the touch panel or the modular cable.</p>	
<p><b>Part 3 After pushing the "I" (HYD) button one time:</b></p> <p>a. The red indicator light above the "I" (HYD) button does not come on.</p>	<p>Check the voltage on the (BROWN) 6120 wire in the 3 pin UML connector. It should be 12.5 volts or more. Check that the 10 gauge (WHITE) 6230 wire is grounded correctly to the central ground stud. If good voltage is present, replace the control box, touch panel, or cable assembly. If voltage is not present, check the power source for the (BROWN) 6120 wire. Check that the cable between the touch panel and the control box is properly connected.</p>	 <p><b>REFER TO MP85.5005</b></p>  <p><b>REFER TO MP85.5045</b></p>
<p>b. More than two yellow lights are lit or opposite yellow lights are lit.</p>	<p>Unplug the sensing unit MTA connector from the 8" control box. If the lights do not go out, replace the control box. If the lights go out, connect a 12 volt test light to ground. There are five pins for the sensing unit. One pin for ground and one pin for each yellow level indicator light. Touch each of the four pins for the level indicator lights. Only one light per pin should come on. If this is so, replace the sensing unit. If not, replace the control box.</p>	 <p><b>REFER TO MP85.5005</b></p>
<p>c. The "NOT IN PARK / BRAKE" light is lit.</p>	<p>Check that the transmission is in the proper park position and that the park brake is set. Some park brakes automatically set when the transmission is placed in park. Trace the (BLUE) 9000 wire in the 6 pin UML connector to its source. Check for the proper position of the diode arrangement. Check the brake switch for proper function.</p> <p><b>NOTE:</b> Most coaches complete a ground signal through the brake switch but some do have a +12 signal. Make sure the proper box is being used. Use a jumper wire to apply the proper signal to the (BLUE) 9000 wire. If the "NOT IN PARK/BRAKE" light does not go out, replace the control box.</p>	 <p><b>REFER TO MP85.5005</b></p>  <p><b>REFER TO MP85.5035</b></p>

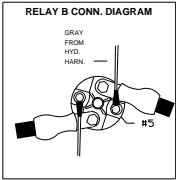
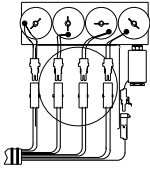
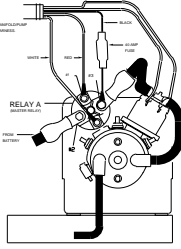
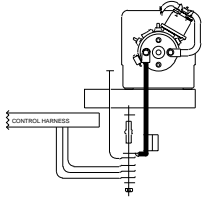
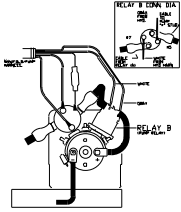
PROBLEM	SOLUTION	FIGURES	
<p><b>Part 3</b> <b>Continued</b></p> <p>d. The pump comes on at this time.</p>	<p>If possible, release the park brake. If the pump continues to run replace relay B. Otherwise, check Terminal 5 with a 12 volt test light connected to ground. If +12 volts is present, the problem is with the control box. If +12 is NOT present replace relay B.</p>	 <p><b>REFER TO MP85.5030</b></p>	
<p>e. All the indicator lights on the touch panel come on and stay on.</p>	<p>If all the indicator lights come on and stay on, replace the control box. <b>NOTE:</b> All indicator lights will flash momentarily when turning the system on.</p>		
<p><b>Part 4</b> <b>Manual Operation</b></p> <p>a. The proper jacks do not extend when an up arrow is pushed.</p>	<p>The problem is probably the hose routing or wire connections at the manifold. Check the wiring and hydraulic diagrams for proper routings.</p>	 <p><b>REFER TO MP85.5040</b></p> <p>b. The pump does not come on.</p> <p>If the LOW BATTERY light comes on, check the 40 amp fuse in the (BLACK) 6800 wire.</p> <p>Push the "OFF" button then the "I" (HYD) button one time. Check Terminals 1,2 and 3 of relay A. They should have +12 volts. If Terminal 1 does not have +12 volts, the control box or the (RED) 8500 wire is bad. If Terminal 2 has no voltage, check the cable, cable ends and battery. If Terminal 3 has no voltage, connect a test light to Terminal 2 and check Terminal 8. Terminal 8 supplies ground for relay A. If the test light comes on, replace relay A. If the test light does not come on, check that all wires are properly hooked up to the grounding stud and that the grounding stud is tight and properly attached to the vehicles frame. The (WHITE) 6231 wire on Terminal 8 could be bad. Check the 40 amp in-line fuse holder on the #10 wire connected to Terminal 3. If Terminals 1,2 and 3 are OK proceed.</p> <p>The following test must be performed while an up arrow is being pushed. With a test light hooked to ground , check Terminals 5 and 6 while the up arrow is being pushed. If Terminal 5 has no voltage, check the pump fuse at the control box. If the fuse is good replace the control box. If the fuse is blown the gray wire may be shorted or relay B may be bad.</p> <p>If Terminal 5 has voltage but not Terminal 6, check Terminal 7 with a test light hooked to Terminal 2 of relay A. Terminal 7 supplies the ground for relay B. If the test light comes on, replace relay B. If the test light does not come on check the connections at the grounding stud. Make sure the grounding stud is properly attached to the frame. The (WHITE) 6231 wire could be bad.</p> <p>If Terminal 5 and 6 have voltage, check the connection at Terminal 9. Check that the connection at Terminal 10 is tight. Check that the pump ground cable is properly attached to the grounding stud. <b>NOTE:</b> Some pumps will not have Terminal 10 or a ground strap. Check that the pump has a good solid frame mount. If all connections and mountings are okay, replace the pump.</p>	 <p><b>REFER TO MP85.5030</b></p>  <p><b>REFER TO MP85.5045</b></p>  <p><b>REFER TO MP85.5030</b></p>

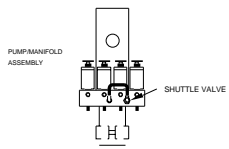
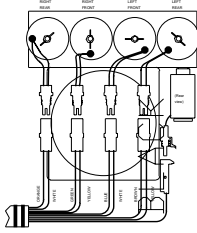
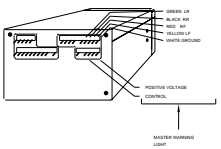
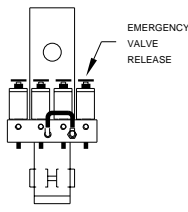

PROBLEM	SOLUTION	FIGURES
<p><b>Part 4 Continued</b></p> <p>c. The pump runs under no load and nothing happens, or jacks extend but will not lift the vehicle.</p>	<p>If the vehicle is equipped with a HWH room extension, check that that the room retract solenoid valve is not open.</p> <p>Disconnect the pressure tube between the manifold and shuttle valve. Connect the pressure gauge to the fitting in the manifold. (Not the shuttle valve.) Turn the pump on for 5 to 10 seconds. The pressure should be approximately 3500 PSI. If there is low pressure, (less than 3100P.S.I.) change the power unit. If the pressure is okay change the shuttle valve.</p>	 <p><b>REFER TO MP65.0</b></p>
<p>d. A jack will not extend when the up arrow is pushed. (or extends slowly)</p>	<p>Check the fuse at the control box for the jack that is not working. A shorted solenoid valve or harness wire can blow the fuse. If the fuse is not blown, continue.</p> <p>If the problem is a front jack, interchange wires for the front solenoids. If the problem is a rear jack, interchange the wire for the rear solenoids. Retry using the correct up arrow . If the problem stays with the same jack, the problem is the jack, hydraulic line to the jack, the inner check valve or the solenoid valve. Open the T-Handle for the valve and retry. If the jack extends replace the solenoid valve. If the jack does not extend, reconnect the wires properly and swap the hoses. If the jack will not extend, the problem is the hose or the jack. If there is no fluid flow to the jack, replace the hose. If there is fluid flow, replace the jack. If the jack extends with the hoses swapped, the problem may be the inner check valve. Contact HWH Customer Service if a check valve problem is present.</p>	 <p><b>REFER TO MP85.5040</b></p>
<p>e. A jack will not stay extended when the up arrow is released.</p>	<p>Make sure the solenoid valve T-Handles are closed. Push the OFF button on the Touch Panel as soon as the EXTEND (up arrow) button is released. If the jack stays down replace the control box. If the jack does not stay down replace the solenoid valve.</p>	
<p>f. A red warning light will not come on when its jack is extended 2 inches.</p>	<p>When operating the jacks using the manual buttons, make sure the proper warning light comes on as a jack extends. Return the jacks to the store position. Unplug the jack warning switch for the light not working. The warning switch has a 2-pin connector. Put a jumper wire between the 2 pins of the harness connector. If the light comes on, replace the warning switch. If the light does NOT come on, unplug the orange MTA connector for the warning switches at the control box. Use a 12 volt test light connected to the ground pin for warning switch inputs. Touch each pin in the control box. If the red warning lights work properly, the wire from the jack is bad. If the red lights DO NOT come on, replace the control box.</p>	 <p><b>REFER TO MP85.5010</b></p> <p><b>REFER TO MP85.5005</b></p>
<p>g. One or more jacks will not retract or retracts very slowly.</p>	<p>Refer to Part 10 of Section 1. If the T-Handle release does not work, loosen the hydraulic line for that jack at the manifold. If the jack retracts properly the problem is the solenoid valve or velocity valve. Remove the fitting from the velocity valve. Remove the poppet and 2 springs. Replace the fitting and retry. If the jack retracts properly, replace the velocity valve. If not replace the solenoid valve. If the jack does not retract after the valve has been replaced, the problem may be the outer check valve. Contact HWH Customer Service if a check valve problem is present. If the jack does not retract, loosen the hydraulic line at the jack. If the jack retracts, the line is bad. If the jack does not retract, replace the cylinder.</p>	 <p><b>REFER TO MP65.0</b></p>

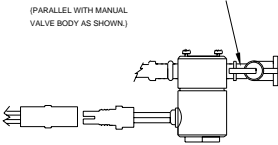
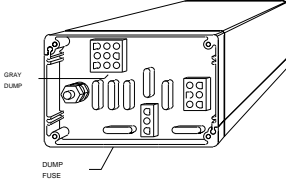
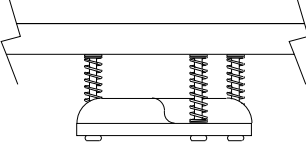
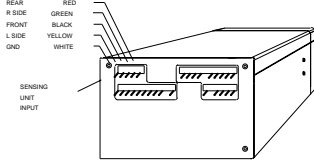
PROBLEM	SOLUTION	FIGURES
<p><b>Part 4 Continued</b></p> <p>g. One or more jacks will not retract or retract very slowly.</p>	<p><b>If the jack retracts with the T-Handle</b>, check for voltage in the plug for that valve while the retract button is being pushed. If voltage is present the solenoid valve is bad. If voltage is not present, the problem is the harness or the control box. Check for voltage for that valve at the control box.</p> <p>If no jacks can be retracted with the T-Handles, replace the shuttle valve.</p>	
<p><b>Part 5</b></p> <p>a. Air will not dump from the suspension.</p>	<p>With the leveling system off and the ignition on, check between the wires going to the air dump valves for +12 volts while the dump button is being pushed. If +12 volts is present replace the valve. If +12 volts is not present, check the 5 amp air dump fuse. Check for +12 volts on the (GRAY) 9300 wire in the 9 pin UML connector at the control box. If +12 is not present replace the control box. Check that the white wire has a ground. <b>NOTE:</b> Some air dump valves are equipped with an emergency shut off valve. Make sure this valve is open.</p>	<p>IF AIR DUMP SOLENOID IS EQUIPPED WITH MANUAL SHUT OFF, KEEP SHUT OFF IN THE OPEN POSITION. (PARALLEL WITH MANUAL VALVE BODY AS SHOWN)</p>  <p><b>REFER TO MP75.2</b></p>
<p>b. Air dump valves will not close.</p>	<p>With the ignition on, Check the (GRAY) 9300 wire in the 9 pin UML connector at the box. If +12 volts is present, replace the control box. If +12 volts is not present, replace the air dump valve. If the valve is closed but the vehicle will not return to proper ride height, the problem is probably in the height control valve or the air supply from the suspension system.</p>	 <p><b>REFER TO MP85.5005</b></p>
<p><b>Part 6 Yellow level indicator does not work properly.</b></p>	<p>The sensing unit is a 4 inch diameter disk that is usually mounted on the under side of the vehicle towards the middle of the vehicle. Occasionally it will be found inside the coach or in a storage compartment. Check that the unit is not mounted, nor the wires routed near a heat source. Check that the sensing unit is mounted correctly according to the sticker on the sensing unit. The sensing unit is adjusted by drawing up the corresponding screws (if the sensing unit is mounted under the vehicle) to put out the yellow lights. If the yellow lights are not working properly, unplug the sensing unit at the control box. Using 12 volt test light connected to ground, touch each pin in the control box for the sensing unit. Check that the proper yellow light on the touch panel comes on when its pin is touched. Only one light should be lit when a pin is touched. If there is a malfunction here, replace the control box. If the control box is okay, replace the sensing unit. Remember to keep the sensing unit away from any heat source.</p>	 <p><b>REFER TO MP85.9505</b></p>  <p><b>REFER TO MP85.5005</b></p>
<p><b>Part 7 After pushing the "I" (HYD) button a second time :</b></p> <p>a. The red indicator light does not flash.</p>	<p style="text-align: center;"><b>AUTOMATIC LEVELING</b></p> <p>The problem is in the touch panel or control box. Make sure all Touch Panel and Control Box connections are OK.</p>	

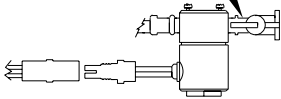
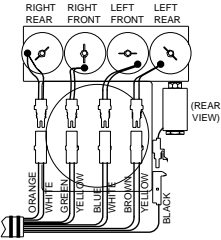
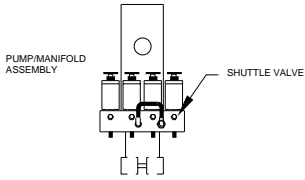
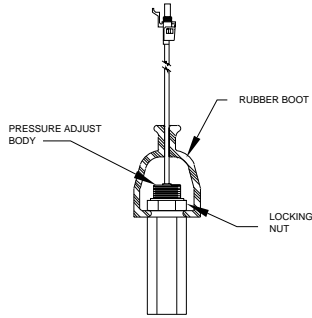
PROBLEM	SOLUTION	FIGURES
<p><b>Part 7 Continued</b></p> <p>b. The air does not dump at this time. (If applicable)</p>	<p>Recheck Part 6a of this section. If the air will dump manually but not automatically, replace the control box. If the air will not dump at all, check that the correct control box was used.</p>	<p>IF AIR DUMP SOLENOID IS EQUIPPED WITH MANUAL SHUT OFF, KEEP SHUT OFF IN THE OPEN POSITION, (PARALLEL WITH MANUAL VALVE BODY AS SHOWN)</p>  <p><b>REFER TO MP75.2</b></p>
<p>c. The vehicle will not level correctly according to the yellow level indicator lights.</p> <p>The "EXCESS SLOPE" light comes on when it shouldn't or won't come on when it should.</p>	<p>It is assumed at this point wiring and hose routings have been checked and are okay. It is also assumed that the sensing unit is functioning properly. Recheck the manual operation of the system. If the excess slope light is coming on and a jack has not reached full extension, unplug the wire to the pressure switch on the manifold and retry. If it now works replace the pressure switch. If not the jack may be too small. Check with HWH. If the excess slope light will not come on when two jacks reach full extension, disconnect the tube between the shuttle valve and the manifold. Check the pump pressure. If the pump pressure is okay, retry in automatic leveling and short the wires to the pressure switch together while the pump is running with a yellow leveling light on. If the excess slope light does not come on, replace the control box. If the light comes on replace the pressure switch. During the leveling process, at no time should any jacks retract. If the vehicle or a corner of the vehicle seems to drop or a jack is retracting while the pump is running, the problem is an internal check valve. Contact HWH Corporation, 1-800-321-3494, for proper repair procedure.</p>	 <p><b>REFER TO MP85.5040</b></p>  <p><b>REFER TO MP65.0</b></p>
<p>d. One or more jacks are not stabilizing the vehicle properly.</p>	<p><b>One or more jacks do not reach the ground.</b></p> <p>At this point it is assumed that all jacks will extend and lift the vehicle. If the jack does not attempt to move to stabilize the vehicle, unplug the jacks pressure switch for that jack and retry. If the jack now extends and lifts the vehicle during stabilize, replace the pressure switch. If it still does not move review Part 5 of Section 1.</p> <p><b>NOTE:</b> With a jack pressure switch unplugged, that jack will lift the vehicle out of level. Do not allow the jacks to over extend when performing this test.</p> <p>If a jack extends but does not reach the ground or lift the vehicle enough, first adjust the pressure switch. Remove the rubber boot from the body of the switch. Unplug the wire so it can rotate freely. Loosen the locking nut and turn the pressure adjust body 1/2 turn clockwise. Retry and repeat the procedure if still not stabilizing. If adjusting the pressure switch does not help, replace the switch. A jack should lift the vehicle at least 1/2" during stabilize. (7d continued on the next page)</p>	 <p><b>REFER TO MP85.5010</b></p>

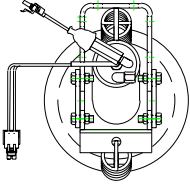
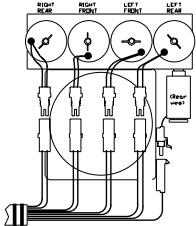
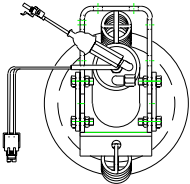
PROBLEM	SOLUTION	FIGURES
<p><b>Part 7d</b> <b>Continued</b></p>	<p><b>One or more jacks lift the vehicle too much during stabilize.</b> The computer must see both front jack pressures before stopping the front jacks. If one front jack pressure switch needs adjustment or is bad, both jacks will lift too much. To adjust the pressure switch to decrease the amount of lift during stabilize, remove the rubber boot from the switch body. Unplug the wire so it can rotate freely. Loosen the locking nut. Turn the pressure adjust body counter clockwise 1/2 turn.</p> <p>Retry and repeat the procedure until the system properly stabilizes the vehicle. A jack should lift the vehicle at least 1/2" during stabilize. If adjusting one front switch does not help, try adjusting the other front switch. The rear jack pressure switches work individually. If adjusting the switches does not help, replace the pressure switch. To determine which front switch is bad, unplug either switch. Use a jumper wire to ground the harness pin for that switch. If the jacks continue to lift too much the switch that remains plugged in is bad and should be changed. If the front jacks now stabilize properly, replace the switch that is unplugged.</p>	 <p><b>REFER TO MP85.5010</b></p>
<p><b>The vehicle will not return to ride height.</b></p>	<p style="text-align: center;"><b>AUTOMATIC RETRACT</b></p> <p>The air dump solenoids are not closing. Recheck Part 6b of this section. Some air solenoids are equipped with emergency shutoff valves. If the dump valves are closed, the height control valve or air supply for the suspension may be the problem.</p>	
<p><b>Part 8</b> <b>After pushing the "I" (HYD) button one time and pushing the "STORE" button:</b></p> <p>a. The pump comes on after pushing the "I" (HYD) button one time.</p>	<p>Solenoid B, the pump solenoid, is probably stuck. The system cannot retract if the pump is running. Recheck Part 3d of this section.</p>	
<p>b. A jack will not retract.</p>	<p>Unplug the left front and the left rear solenoid valves. Put the system in the "STORE" mode. If the right side jacks retract, replace the left rear solenoid valve.</p> <p>Unplug the right front and the right rear solenoid valves. Put the system in the "STORE" mode. If the left side jacks retract, replace the right front solenoid valve.</p>	 <p><b>REFER TO MP85.5040</b></p>
<p>c. Red warning lights on the touch panel do not go out, but the jacks have retracted.</p>	<p>Unplug the warning switch wire. If the light goes out, replace the warning switch. If the light does not go out, check the wire for a short to ground. If the wire is okay replace the control box.</p>	 <p><b>REFER TO MP85.5010</b></p>

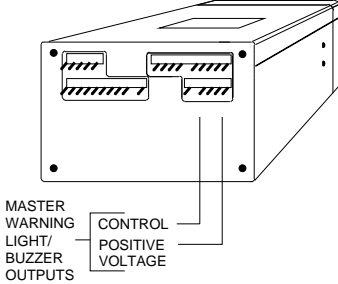
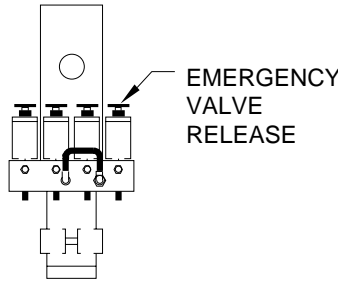
PROBLEM	SOLUTION	FIGURES
<p><b>Part 8 Continued</b></p> <p>d. The master "JACKS DOWN" warning light on the dash will not go out.</p>	<p>Unplug the 6 pin MTA connector and check the ground wire going to the master warning light. If it is not shorted to ground, replace the control box. This light should be on whenever a warning light on the touch panel is on.</p>	 <p><b>REFER TO MP85.5005</b></p>
<p>e. The green travel light will not come on.</p>	<p>The green travel light will not come on if any red warning lights are on. If no red warning lights are lit, replace the control box.</p>	
<p><b>Part 9 Jacks will NOT retract using the T-handle release on the solenoid valves.</b></p>	<p>If none of the jacks will retract using the T-handles, the shuttle valve is bad. If only one jack will not retract using the T-handles, loosen the hydraulic line for that jack. If the jack retracts, replace the solenoid valve. If the jack does not retract, the hose could be kinked or the actuator or jack is bad.</p>	 <p><b>REFER TO MP65.0</b></p>

# HYDRAULIC LINE CONNECTION DIAGRAM LEVELING SYSTEM



FRONT

**NOTE:** BEFORE OPERATING VALVE RELEASE "T" HANDLES, READ AND UNDERSTAND PROCEDURE FOR MANUAL JACK RETRACTION IN OPERATOR'S INSTRUCTIONS.

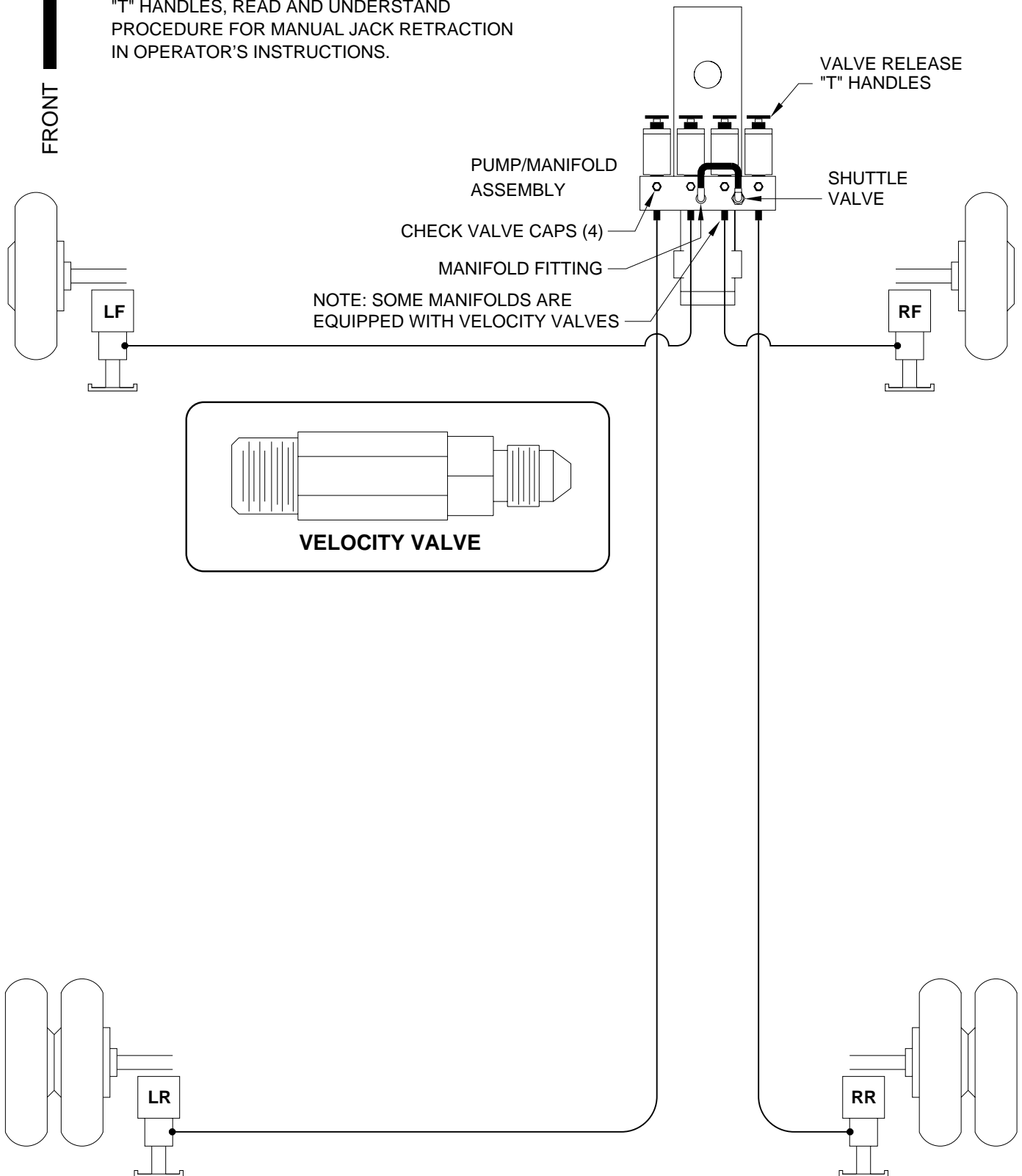

# HYDRAULIC SCHEMATIC

## BI-AXIS LEVELING WITH STRAIGHT-ACTING JACKS

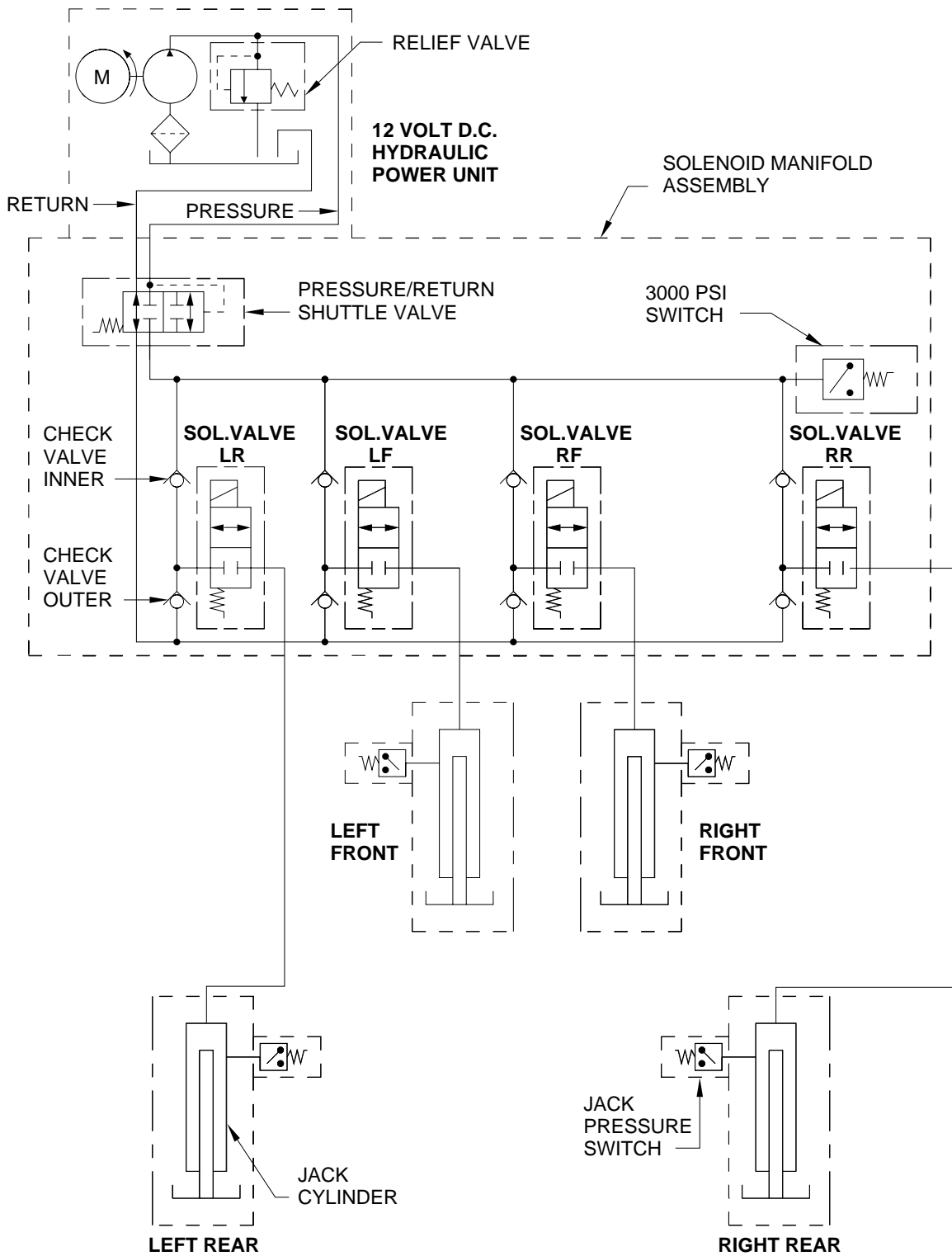

# AIR LINE CONNECTION DIAGRAM

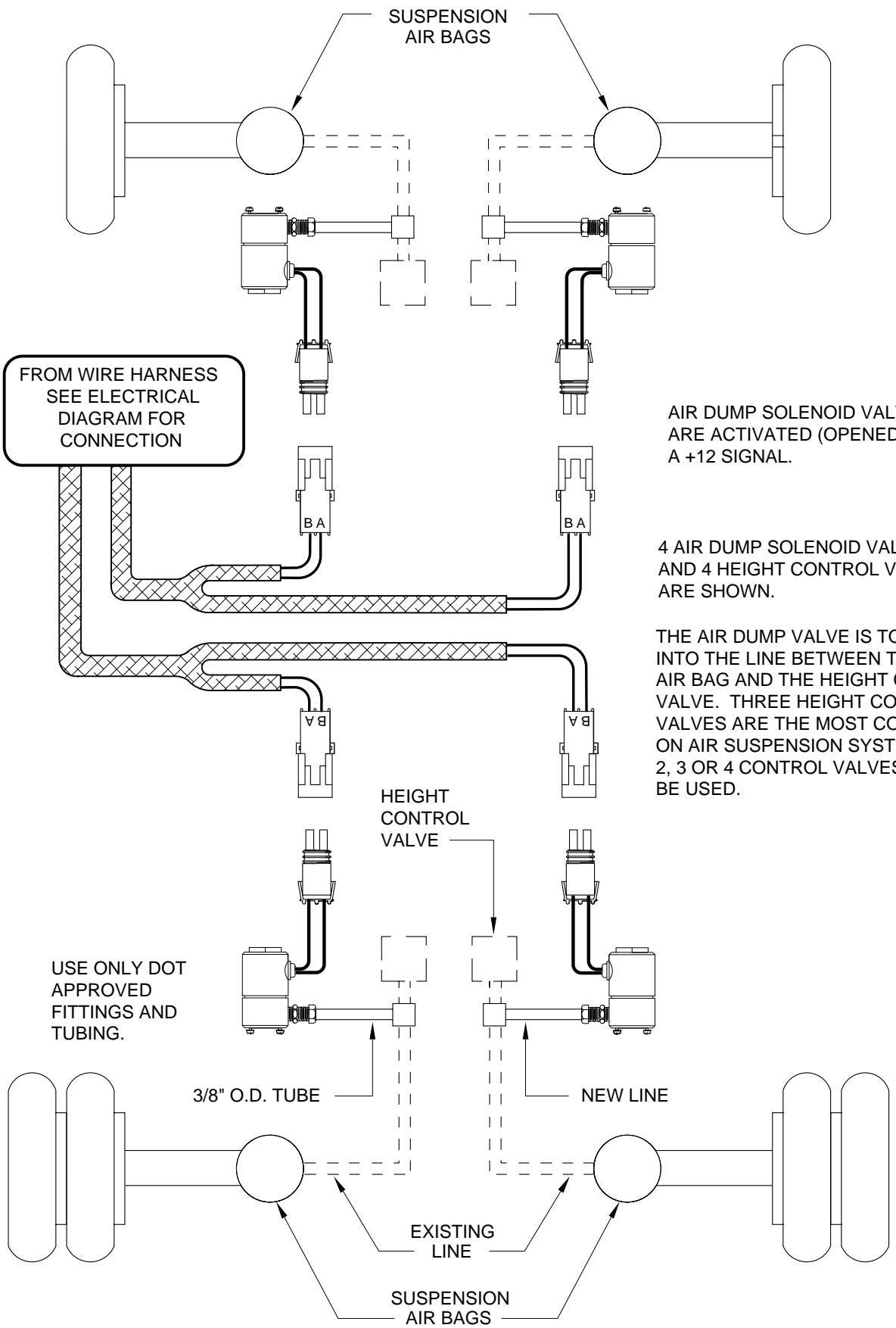

FROM WIRE HARNESS  
SEE ELECTRICAL  
DIAGRAM FOR  
CONNECTION

AIR DUMP SOLENOID VALVES  
ARE ACTIVATED (OPENED) BY  
A +12 SIGNAL.

4 AIR DUMP SOLENOID VALVES  
AND 4 HEIGHT CONTROL VALVES  
ARE SHOWN.

THE AIR DUMP VALVE IS TO TEE  
INTO THE LINE BETWEEN THE  
AIR BAG AND THE HEIGHT CONTROL  
VALVE. THREE HEIGHT CONTROL  
VALVES ARE THE MOST COMMON  
ON AIR SUSPENSION SYSTEMS.  
2, 3 OR 4 CONTROL VALVES MAY  
BE USED.

USE ONLY DOT  
APPROVED  
FITTINGS AND  
TUBING.



# CONNECTION INFORMATION

## 610 SERIES LEVELING SYSTEM

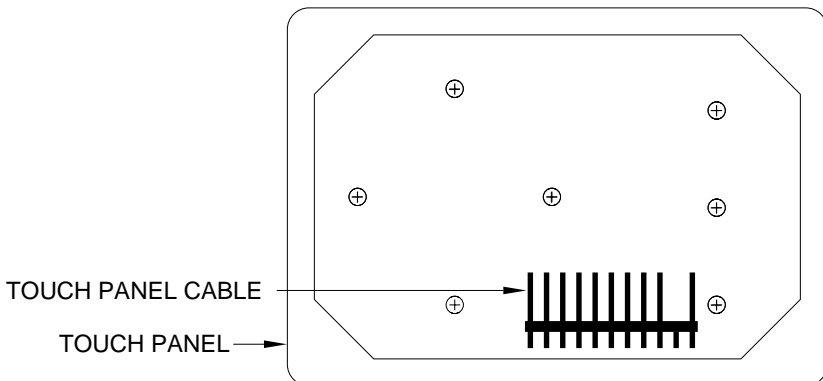
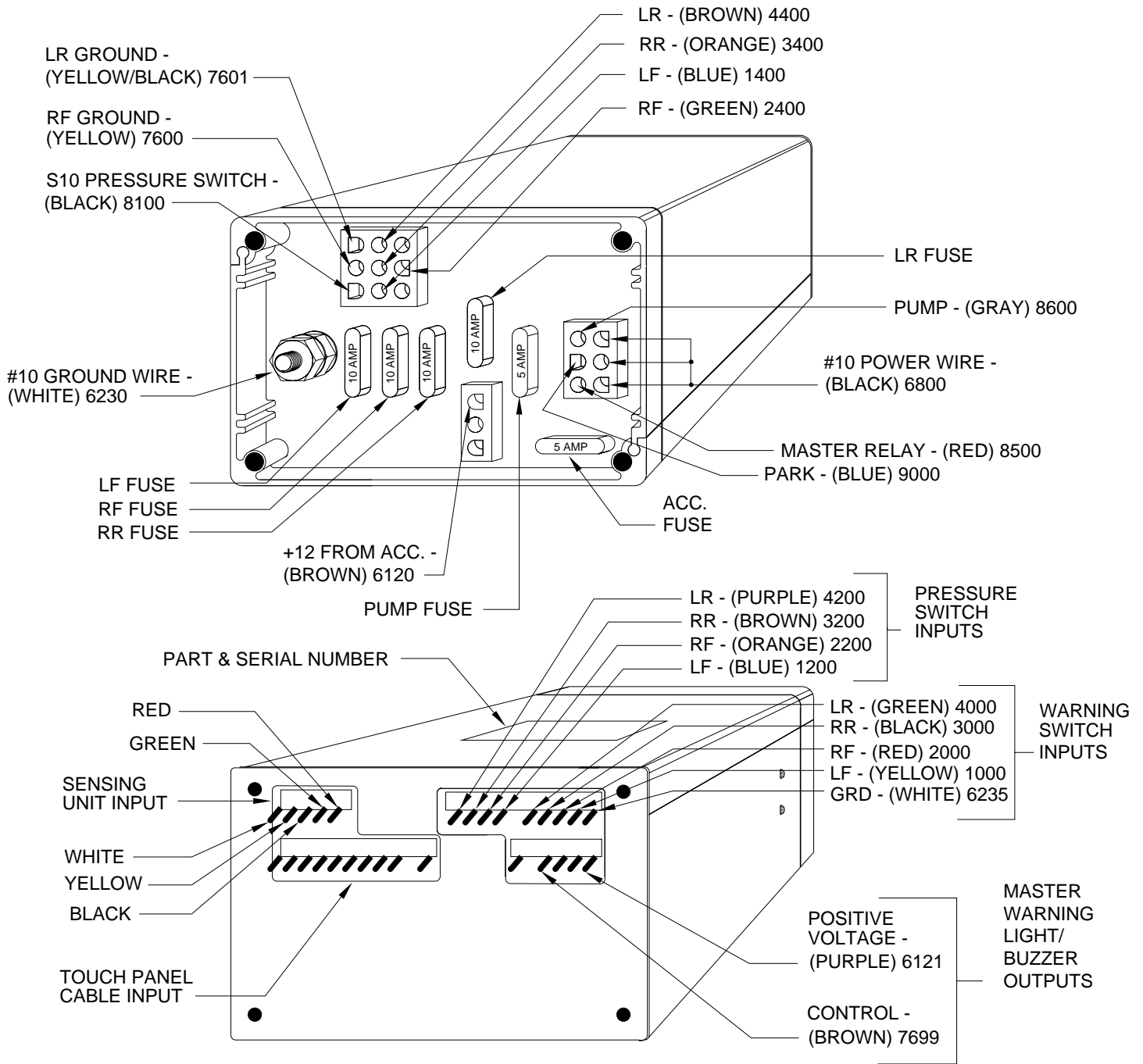

**NOTE: THE (4) DIGIT WIRE NUMBER SUPERSEDES ANY AND ALL WIRE COLORS**

# ELECTRICAL CONNECTION DIAGRAM

## 610 SERIES LEVELING SYSTEMS

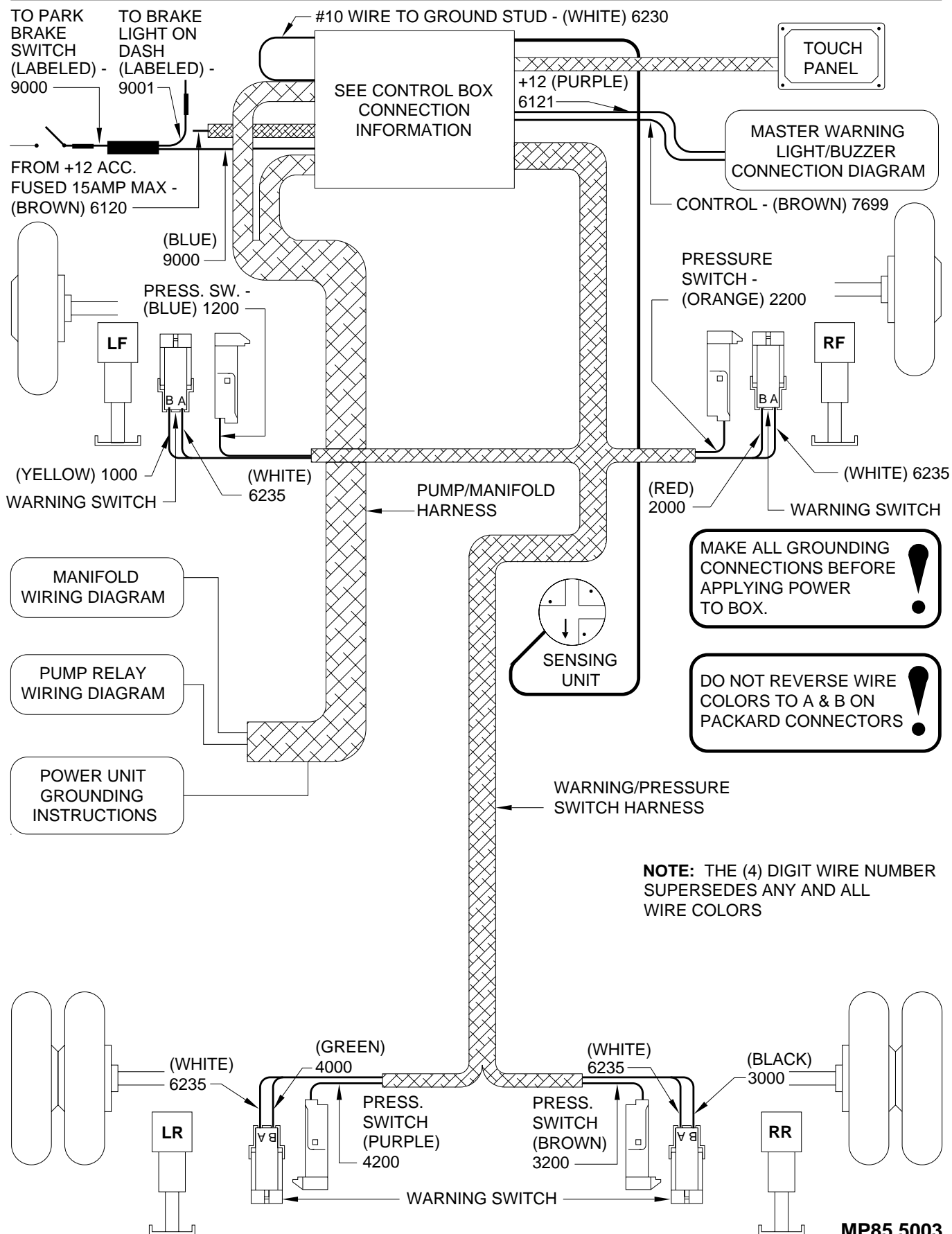

# CONNECTION INFORMATION

## 610 SERIES LEVELING SYSTEMS

### WITH AIR DUMP

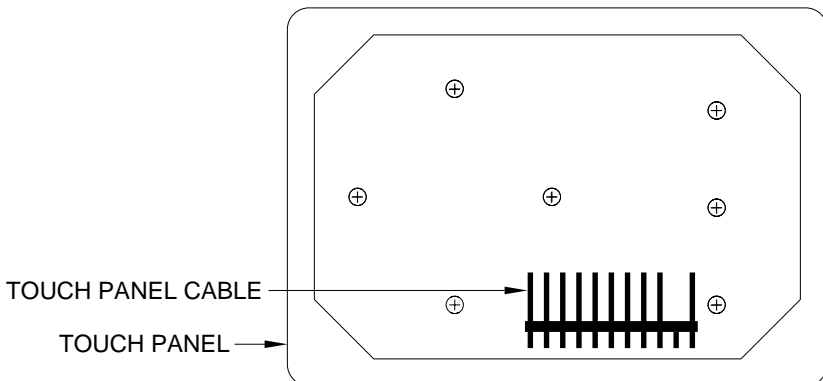
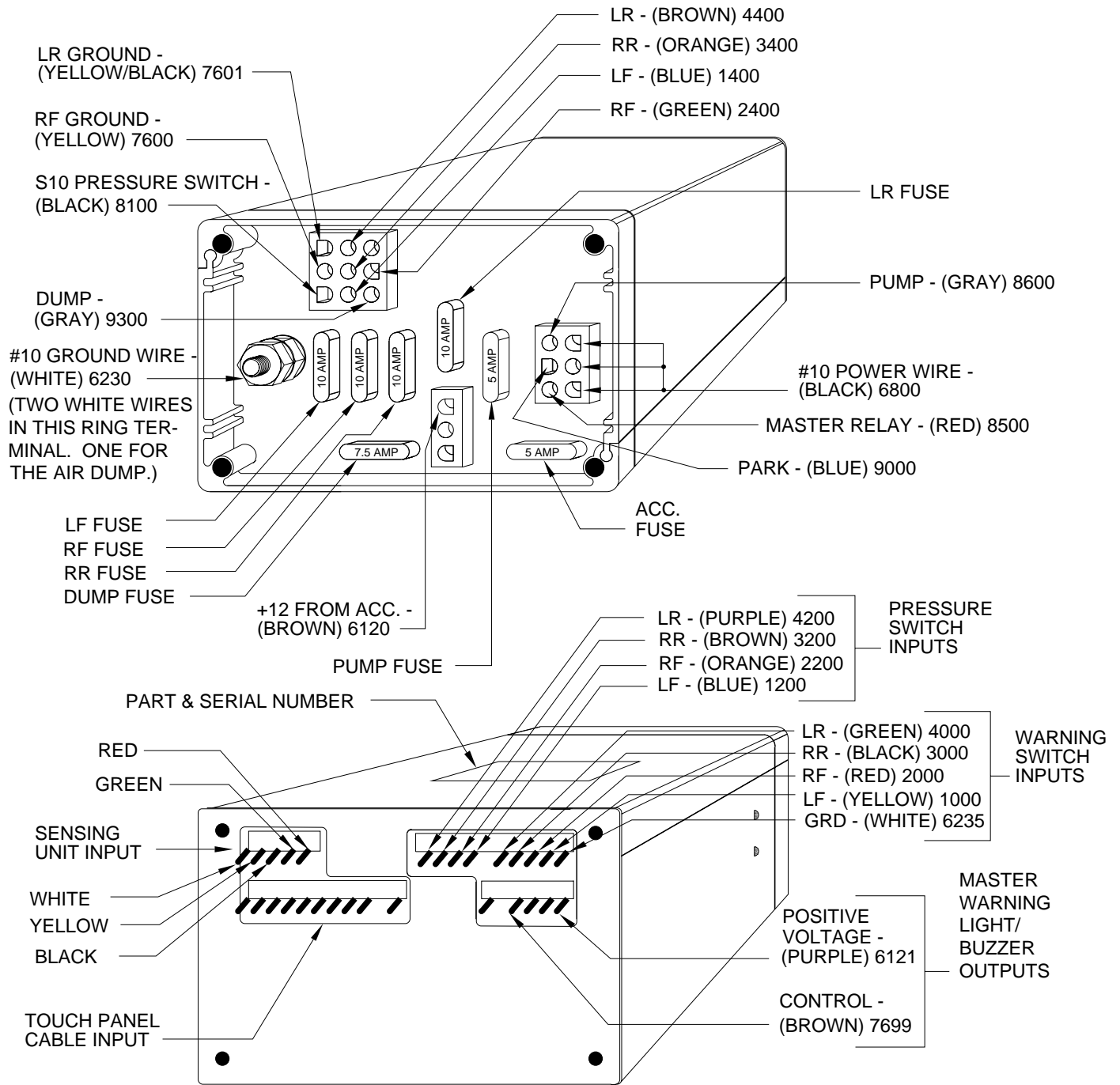

**NOTE: THE (4) DIGIT WIRE NUMBER SUPERSEDES ANY AND ALL WIRE COLORS**

**STRAIGHT ACTING JACK WITH PRESSURE SWITCH  
FOR 610 SYSTEMS 2-WIRE WARNING SWITCH  
RETURN SPRINGS SIDE / SIDE**

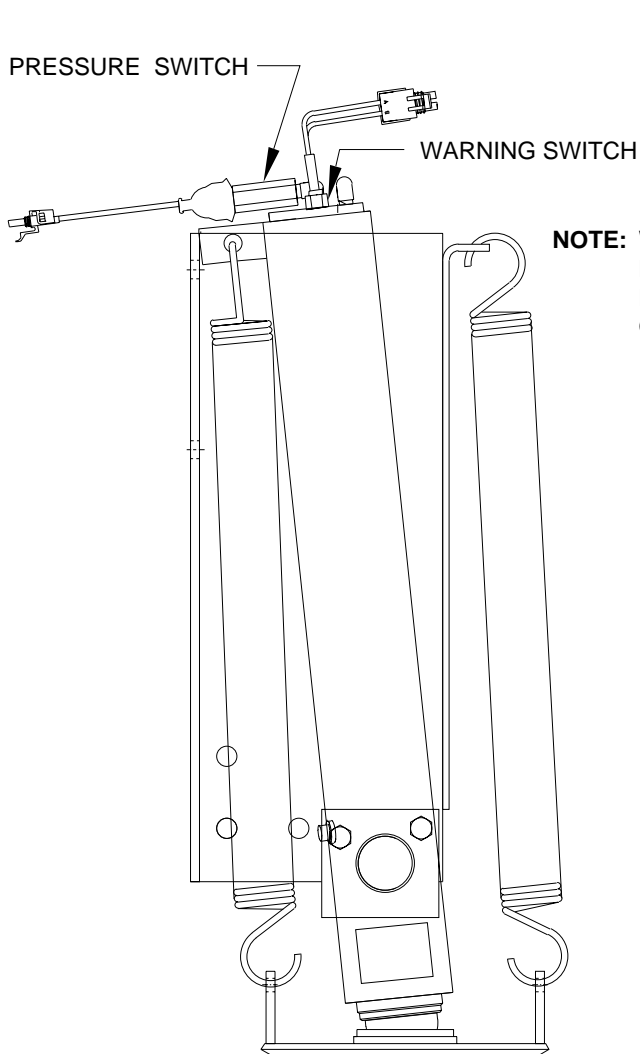
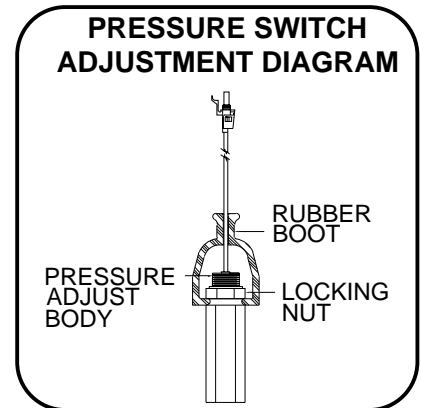
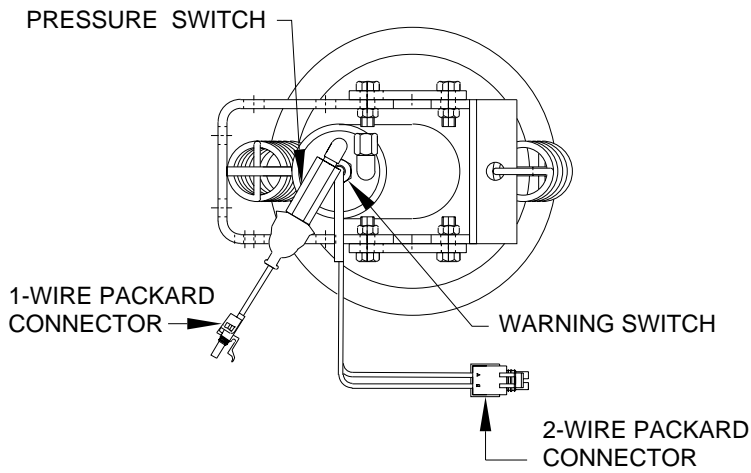

**NOTE:** WARNING SWITCH MAY BE LOCATED LOWER ON THE BODY OF THE JACK.

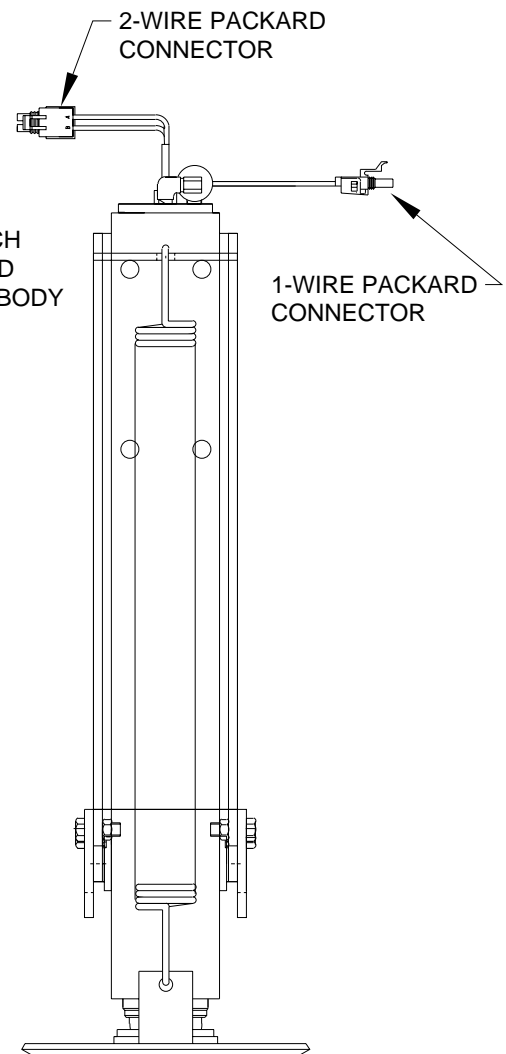

---

# STRAIGHT ACTING JACK WITH PRESSURE SWITCH FOR 610 SYSTEMS 2-WIRE WARNING SWITCH RETURN SPRINGS FORE AND AFT

---

**NOTE:** PRESSURE SWITCH  
MAY BE LOCATED  
ON THE TOP OF THE  
BODY OF THE JACK

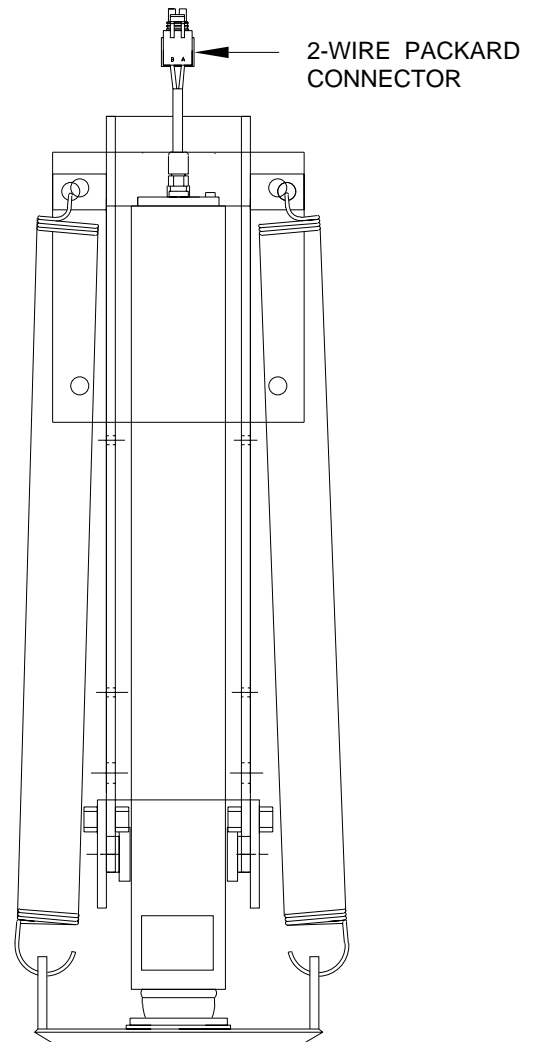
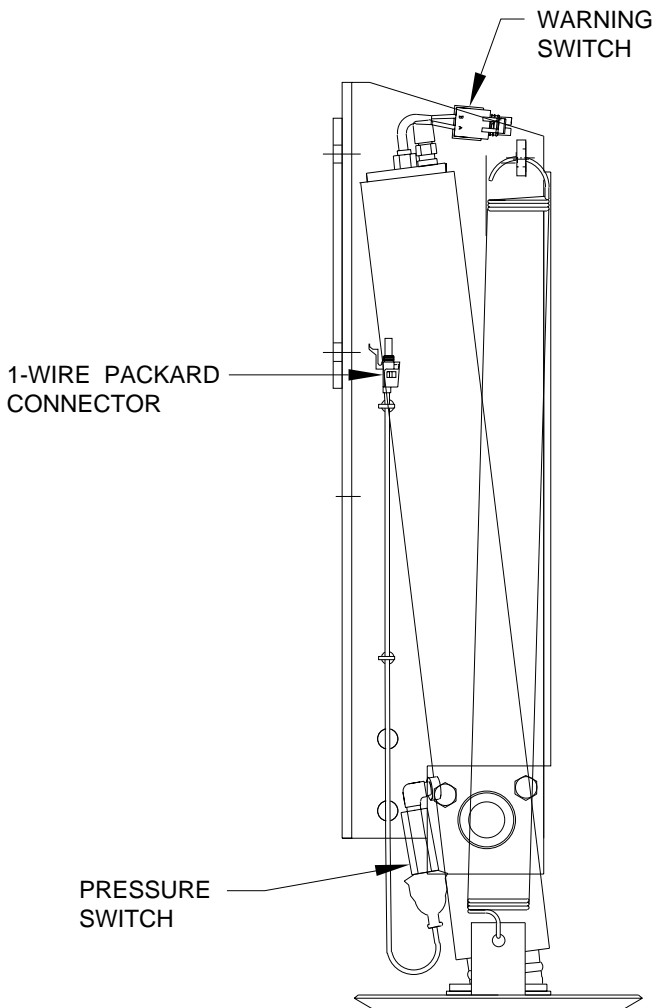
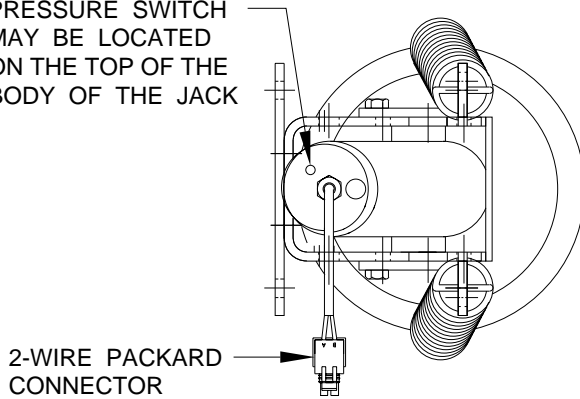

# MASTER AND PUMP RELAY WIRING DIAGRAM FOR 610 SERIES LEVELING SYSTEMS

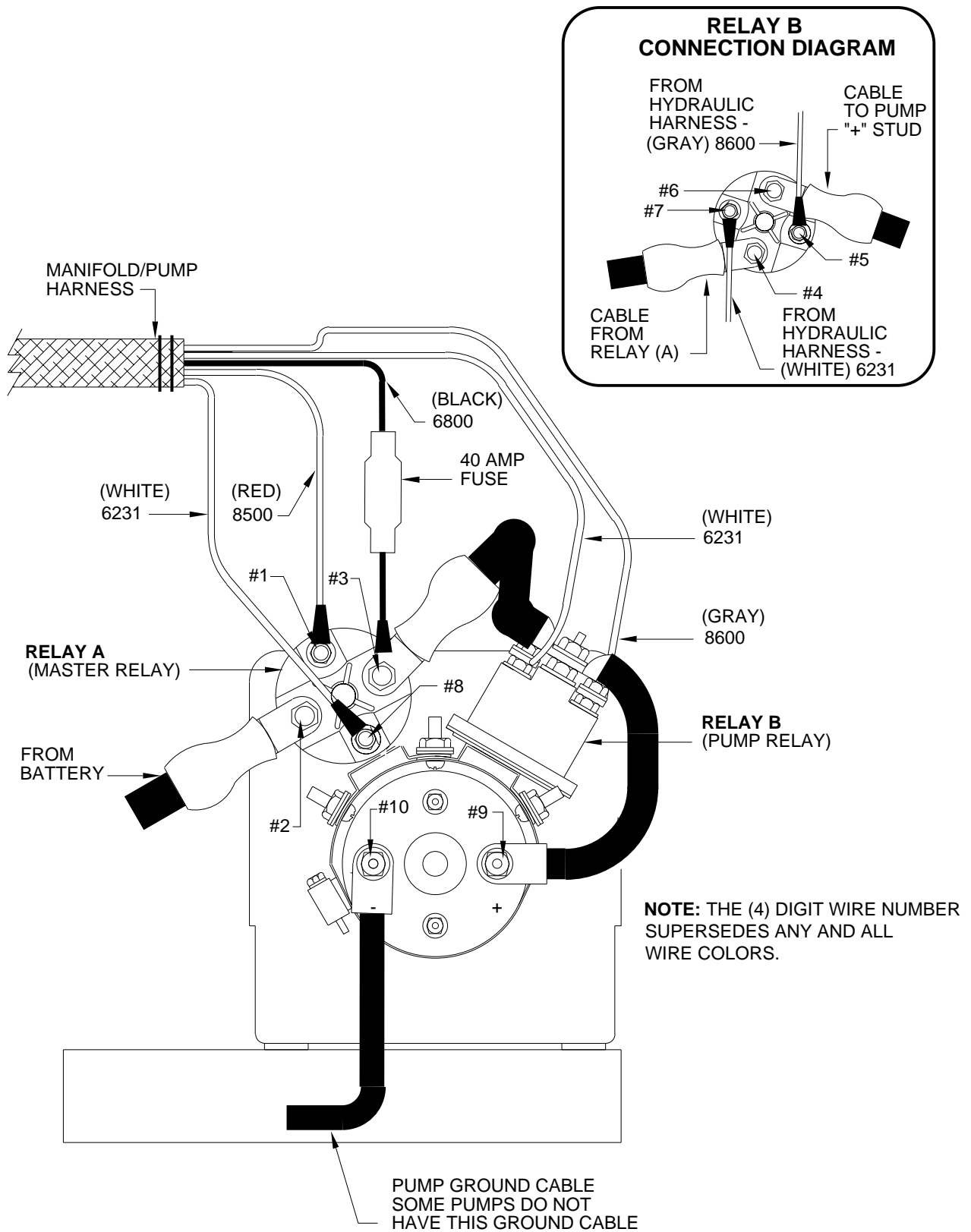

# ELECTRICAL CONNECTION DIAGRAM 610 SERIES LEVELING SYSTEMS WITH AIR DUMP

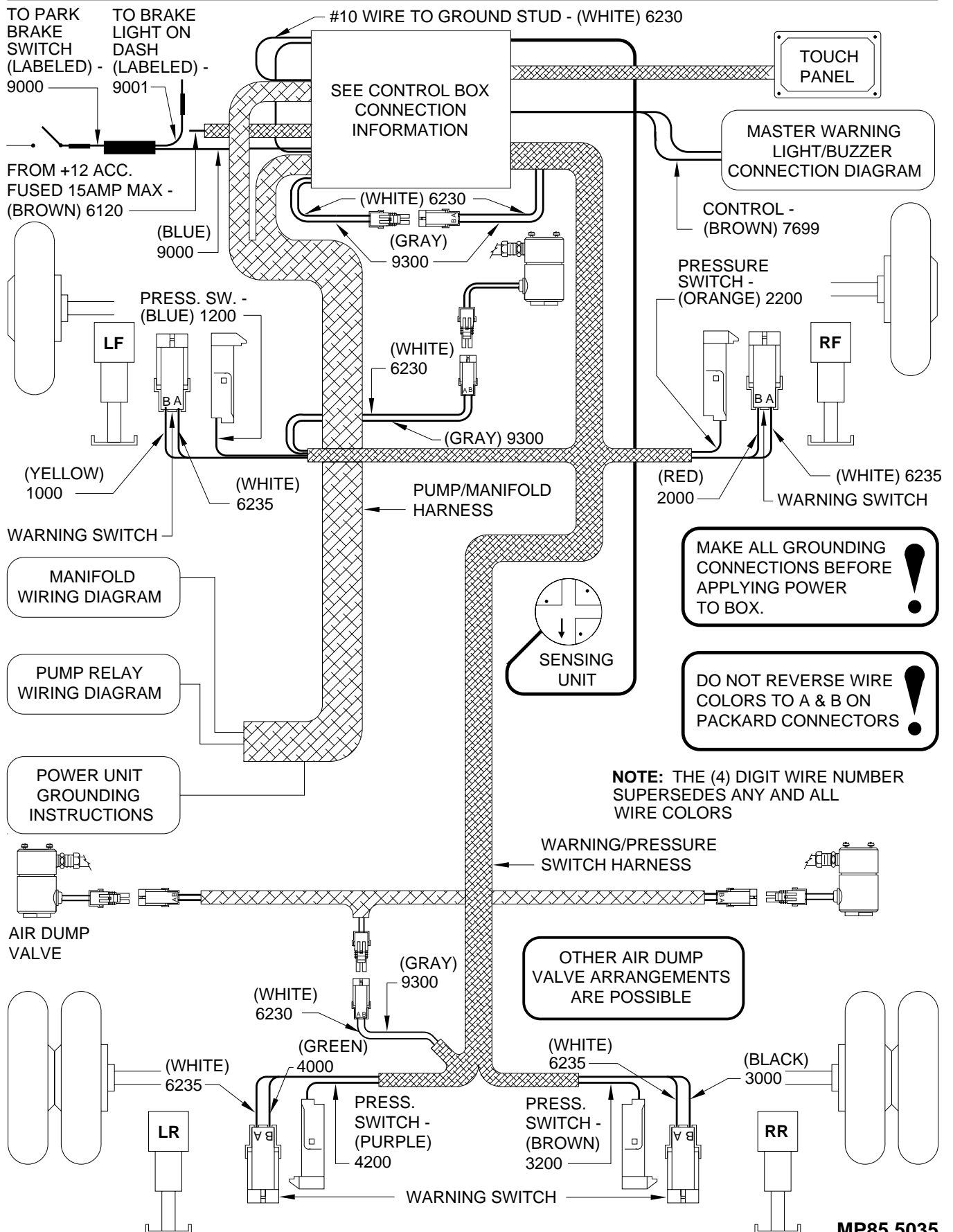

# WIRING DIAGRAM MANIFOLD FOR 610 SERIES LEVELING SYSTEMS

**NOTE:** ROOM EXTENSION MANIFOLD NOT SHOWN.

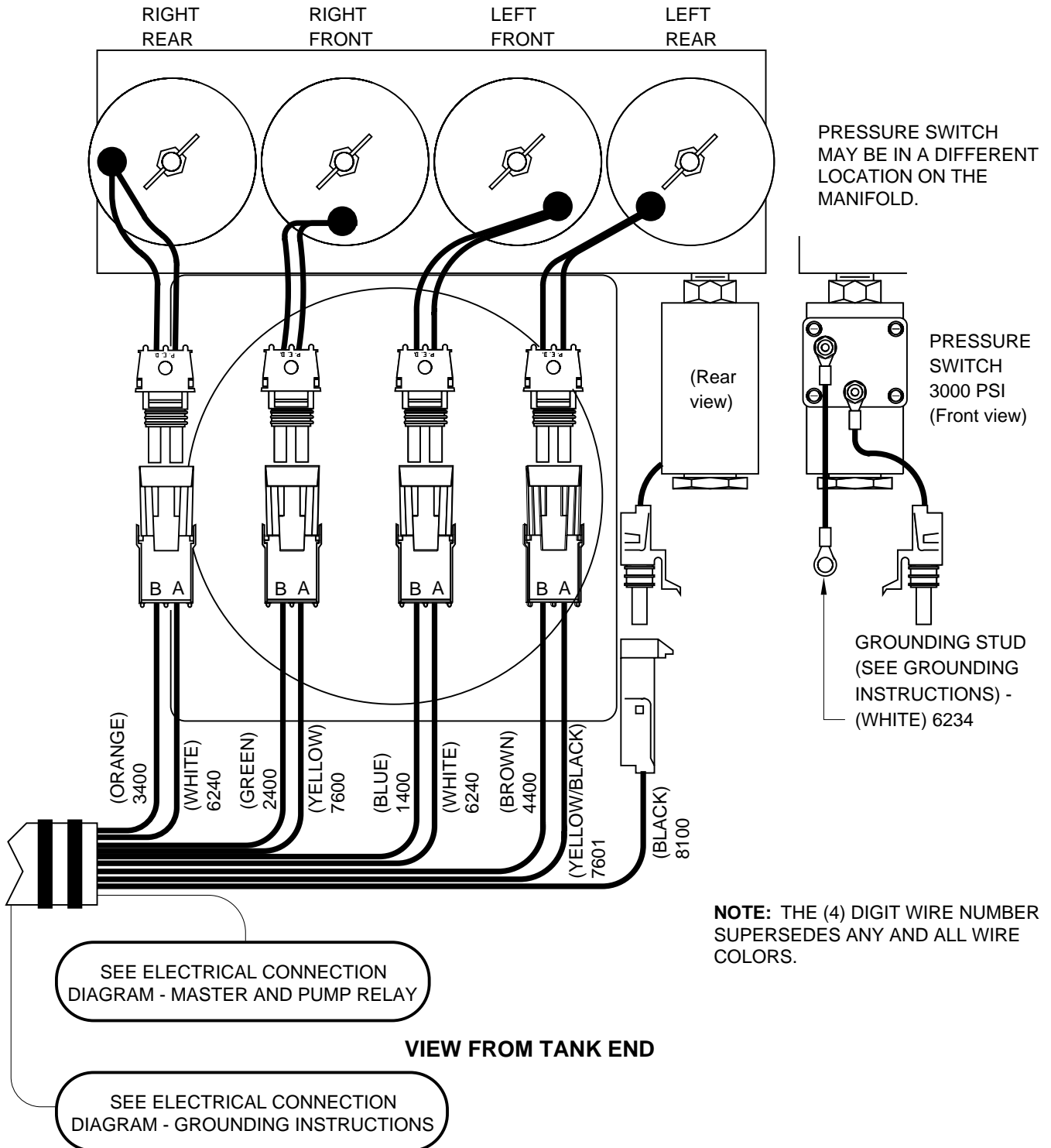



# ELECTRICAL CONNECTION DIAGRAM POWER UNIT/HARNESS GROUNDING INSTRUCTIONS 610 SERIES LEVELING SYSTEMS

## WELDED PUMP MOUNT

Use grounding stud and 3/8" internal star lockwashers as shown.

**IMPORTANT:** STAR LOCKWASHER MUST BE USED BETWEEN GROUNDING SURFACE AND WIRE TERMINALS

**NOTE:** THE (4) DIGIT WIRE NUMBER SUPERSEDES ANY AND ALL WIRE COLORS.

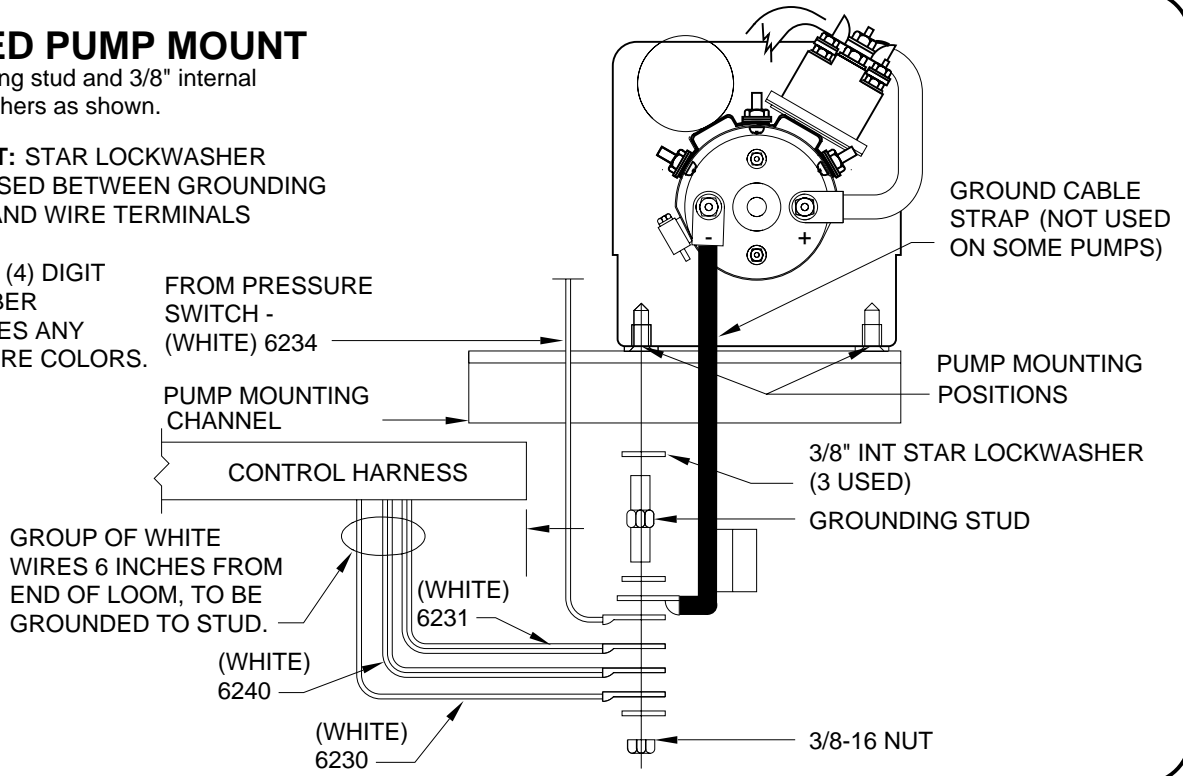

## PUMP MOUNTED REMOTE FROM FRAME

Use grounding stud and 3/8" internal star lockwashers as shown.

**IMPORTANT:** STAR LOCKWASHER MUST BE USED BETWEEN GROUNDING SURFACE AND WIRE TERMINALS

**NOTE:** THE (4) DIGIT WIRE NUMBER SUPERSEDES ANY AND ALL WIRE COLORS.

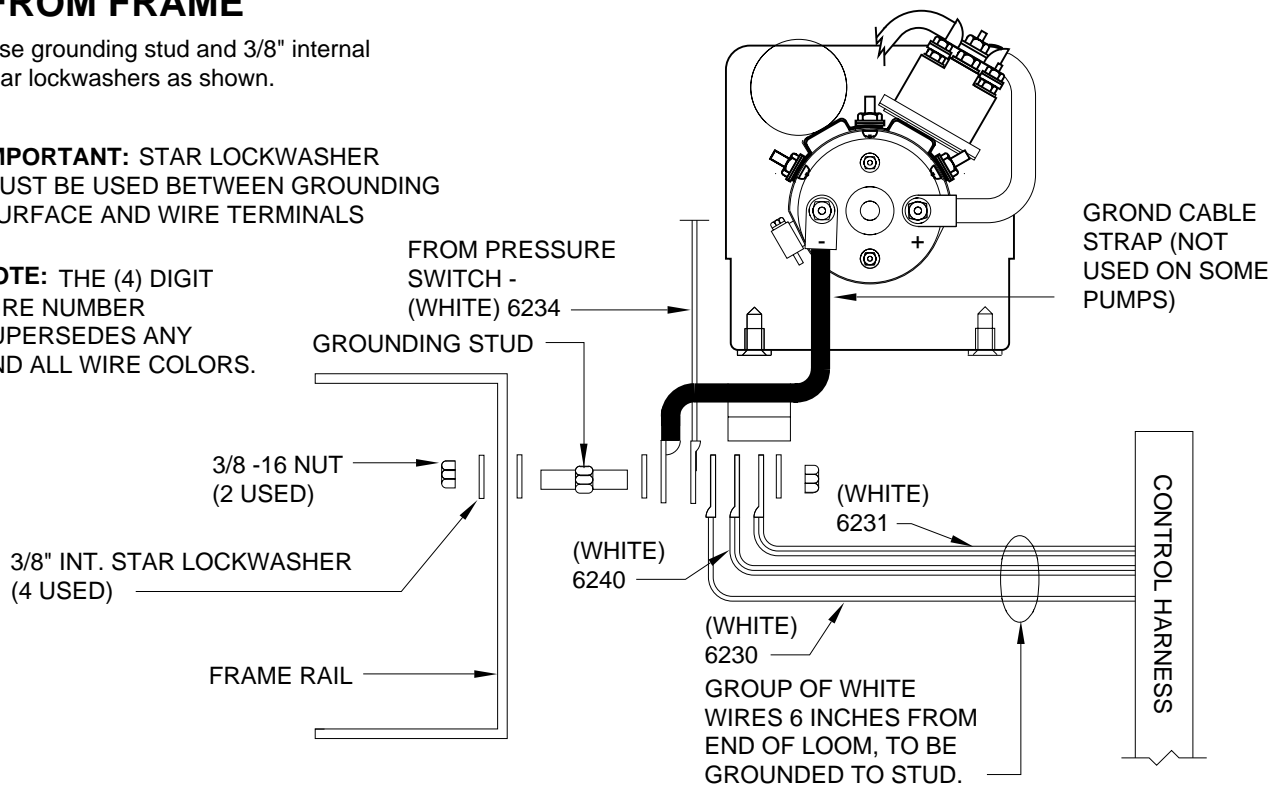

# MASTER LIGHT/BUZZER CONNECTION DIAGRAM COMPUTER-CONTROLLED 610 SERIES LEVELING SYSTEMS

A MASTER WARNING INDICATOR SHOULD ALWAYS BE USED. WHEN THE LEVELING SYSTEM HAS STRAIGHT ACTING JACKS A WARNING BUZZER MUST BE USED.

WHEN ONLY A RED MASTER WARNING LIGHT IS USED THE 12+ POWER FOR THE LIGHT COMES THROUGH THE CONTROL PANEL. (SEE FIGURE 1 BELOW). WHEN BOTH A RED LIGHT AND WARNING BUZZER ARE USED THE +12 POWER FOR BOTH INDICATORS IS SUPPLIED BY THE IGNITION SWITCH. THE POWER MUST COME FROM THE "ON" SIDE OF THE IGNITION SWITCH, NOT THE "ACC" SIDE. (SEE FIGURE 2 BELOW)

**NOTE :** BY SUPPLYING IGNITION POWER TO THE WARNING BUZZER AND LIGHT, AND "ACC" POWER TO THE CONTROL PANEL, THE SYSTEM MAY BE OPERATED IN ACCESSORY WITHOUT THE BUZZER SOUNDING. THE NEGATIVE SIGNAL FOR THE WARNING INDICATORS MUST ALWAYS COME FROM THE CONTROL BOX.

**CAUTION:** THE (PURPLE) 6121 WIRE IN THE MASTER WARNING LIGHT HARNESS IS HOT WHENEVER THE IGNITION IS "ON" OR "ACC". THE (PURPLE) 6121 WIRE MUST BE REMOVED FROM THE HARNESS WHEN USING DIRECT IGNITION VOLTAGE FOR THE MASTER WARNING INDICATORS.

**NOTE :** THE (4) DIGIT WIRE NUMBER SUPERSEDES ANY AND ALL WIRE COLORS.

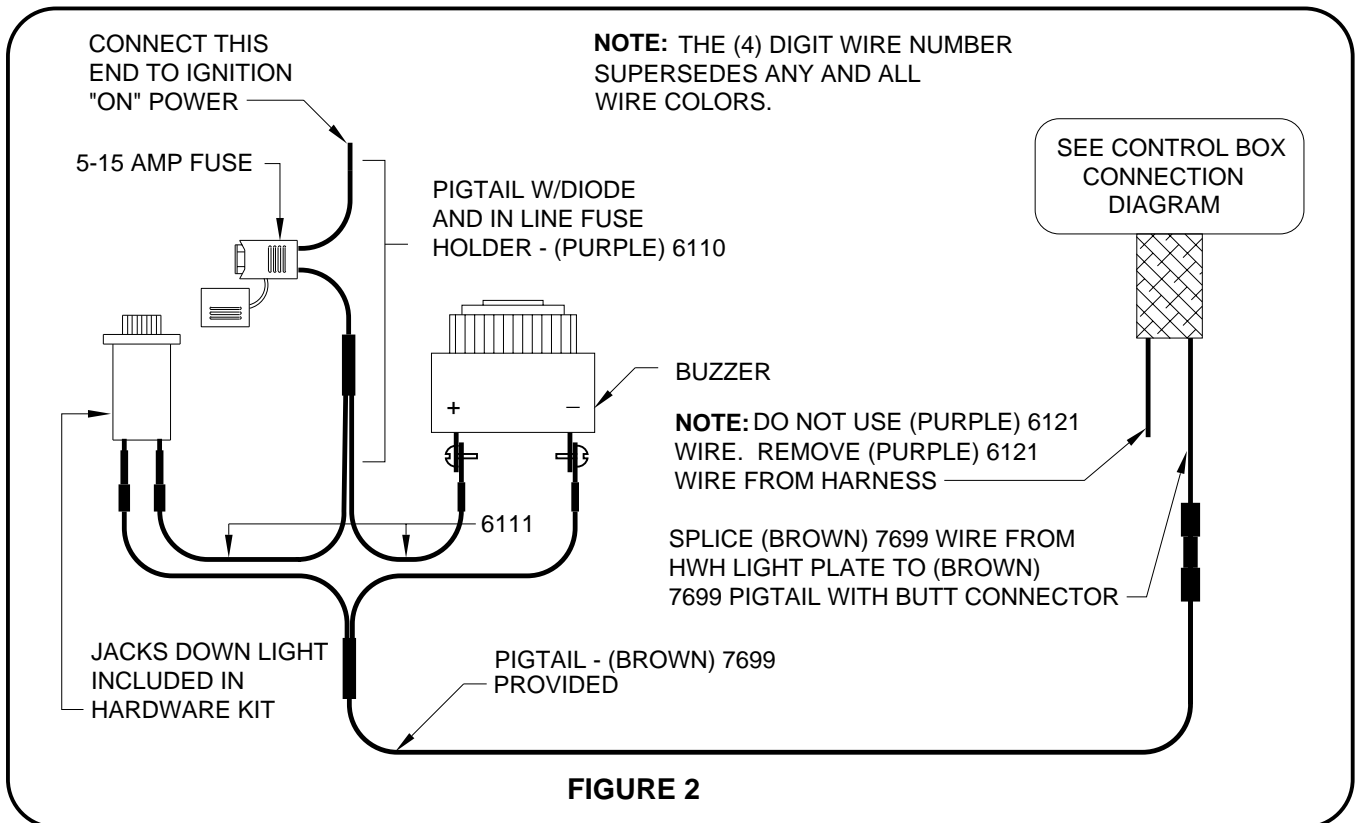
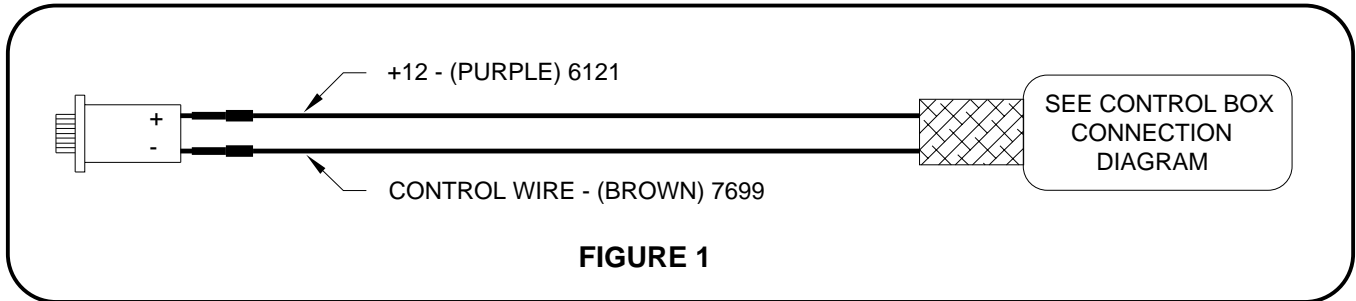

---

# MOUNTING AND ADJUSTMENT INSTRUCTIONS

## LEVEL SENSING UNIT

---

The sensing unit must be mounted to a solid surface and must not be exposed to any heat sources. Toward the middle of the vehicle but outside the frame rails is best. The sensing unit may be mounted between frame rails on pusher vehicles and trailers. The sensing unit may be mounted in a compartment but needs to be protected from stored objects. It is critical that the sensing unit is mounted in the proper position according to the sticker on the sensing unit. (See figure below). The springs should be compressed to approximately 1.25 inches.

The correct method for adjusting the sensor is as follows:

First, level the vehicle by placing a 24" level in the center of the vehicle on the floor. With the vehicle level adjust the sensing unit until all yellow lights are out. This is done by drawing up or backing out the sensing unit screws. If a front light is on, adjust the front screw. If a side light is on adjust the side screw. If a rear light is on adjust the rear screws. One or more screws may have to be adjusted to turn the yellow lights out. After adjustment has been made, pull down on the sensing unit to make sure the unit is bottomed out on the screw heads. Check to make sure all yellow lights are out. If not, readjust. Rock the vehicle and re-check for yellow lights, readjust if needed.

**NOTE:** The sensing unit has an accuracy tolerance of +/- 1" side to side and +/- 5.4" front to rear on a 36' vehicle.

