

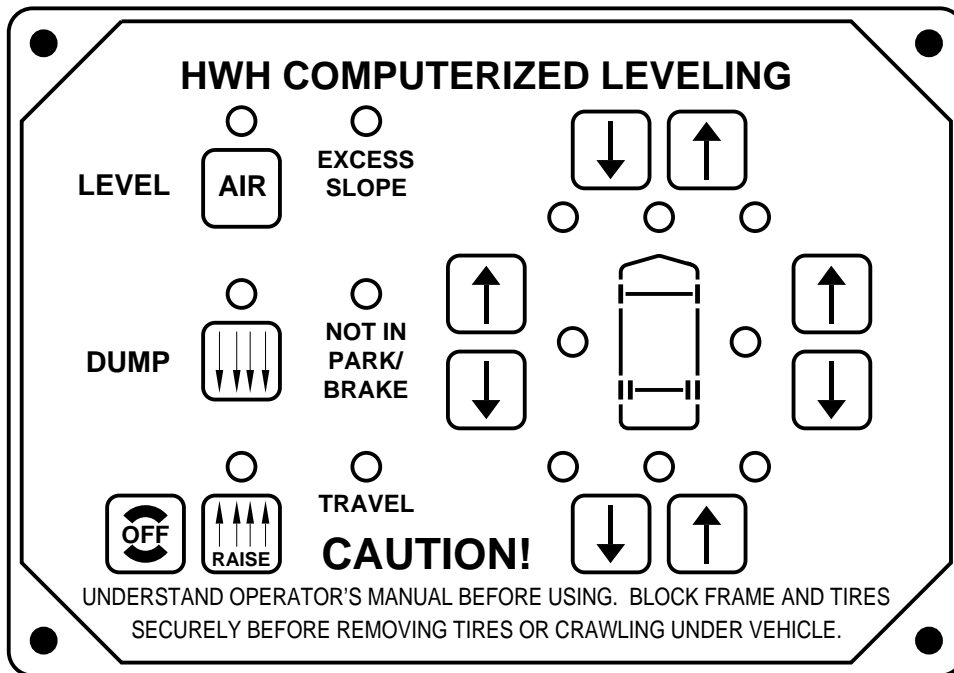

REPAIR MANUAL

HWH COMPUTER-CONTROLLED LEVELING SYSTEM 600 SERIES

FEATURING:
TOUCH PANEL CONTROL
FOUR-POINT AIR LEVELING



HWH CORPORATION
(ON I-80, EXIT 267 SOUTH)
2096 MOSCOW ROAD
MOSCOW, IOWA 52760
(800) 321-3494 / (563) 724-3396
INTERNET: <http://www.hwhcorp.com>

SECTION 1

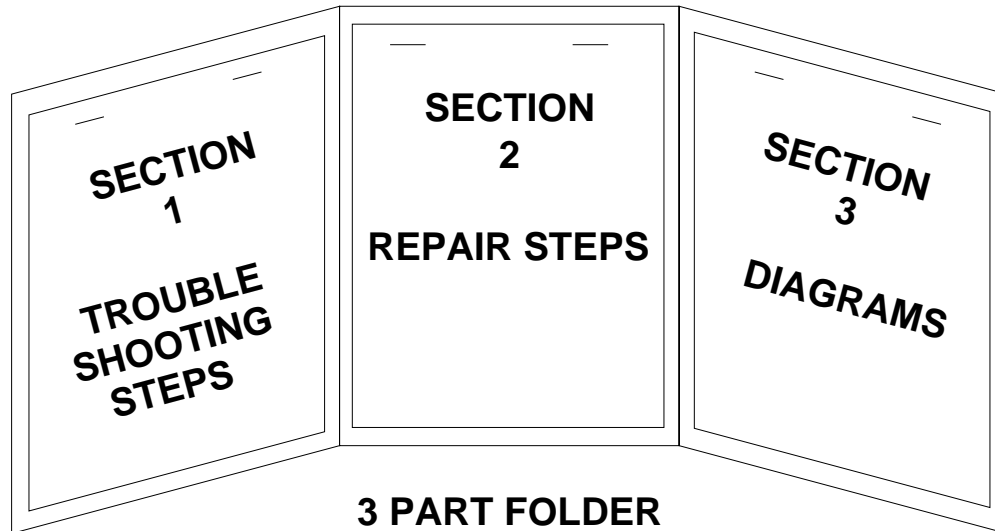

HOW TO USE MANUAL

This manual is written in three sections. Section 1 is the Trouble Shooting Steps. Section 2 is the Repair Steps. Section 3 is the Diagrams. Begin diagnosis of the system with Section 1, the Trouble Shooting Steps. This will give the correct operation and function of the system. When a malfunction is encountered, the Trouble Shooting Steps will direct you to the proper Repair Steps in Section 2, the Repair Steps. The Repair Steps are broken into 3 columns, Problem, Solution, and Diagram. In the proper part under Problems, find the symptom you have encountered. The testing and repair for that problem is in the Solution (center) column. Diagrams for a particular Problem and Solution are in the Diagram (right hand) column. This column will direct you to the proper diagram in Section 3, Diagrams, for a more detailed view.

Before beginning your repair, it is **IMPORTANT** to read the **CAUTIONS** and **NOTES AND CHECKS** in the first section, **TROUBLE SHOOTING STEPS**. In many cases this will save time and mistakes when trouble shooting a system.

This Repair Manual is offered as a guide only. It is impossible to anticipate every problem or combination of problems. This manual is written in sequential order of the proper operation of the system. The Trouble Shooting Steps must be followed in order to give correct diagnosis of the problem(s). For any problems encountered that are not addressed in this manual, contact HWH Corporation for assistance.

NOTE: Diagrams in this manual are of typical systems. There may be plumbing or harness differences. In most cases this should not effect trouble shooting procedures.

PROCEED WITH TROUBLE SHOOTING GUIDE



TROUBLE SHOOTING

CAUTIONS!

BLOCK FRAME AND TIRES SECURELY BEFORE CRAWLING UNDER VEHICLE. DO NOT USE AIR SUSPENSION TO SUPPORT VEHICLE WHILE UNDER VEHICLE OR CHANGING TIRES. VEHICLE MAY DROP AND OR MOVE FORWARD OR BACKWARD WITHOUT WARNING CAUSING INJURY OR DEATH.

DO NOT EXCEED 5 MPH OR TRAVEL LONG DISTANCES WHEN THE SUSPENSION IS NOT AT THE PROPER RIDE HEIGHT.

SAFETY GLASSES ARE TO BE WORN TO PROTECT EYES FROM DIRT, METAL CHIPS, OIL LEAKS, ETC. FOLLOW ALL OTHER SHOP SAFETY PRACTICES.

NOTES AND CHECKS

Read and check before preceding with Trouble Shooting Steps.

NOTE: HWH CORPORATION ASSUMES NO LIABILITY FOR DAMAGES OR INJURIES RESULTING FROM THE INSTALLATION OR REPAIR OF THIS PRODUCT.

1. The trouble shooting guide must be followed in order. Problems checked for in one step are assumed correct and not checked again in following steps.
2. Batteries should be in good condition and fully charged. Low voltage can cause erratic operation.
3. Do not replace the control box unless the repair steps say to replace it. Otherwise the malfunctions may damage the new control box.
4. If the control box is removed, +12 ignition power must be applied to the travel solenoid wires (GRAY) 1700 in the front and (GRAY) 3700 in the rear air harnesses. This will allow the height control valve to function. See MP85451F of section (3) Diagrams.

This manual is intended for use by experienced mechanics with knowledge of air suspension and automotive electrical systems. People with little or no experience with HWH leveling systems should contact HWH technical service (800-321-3494) before beginning. Special attention should be given to all cautions, wiring, and air diagrams.

Special note: When installing a new control box, make sure the box is properly grounded before applying power to the system.

Suggested tools for trouble shooting the HWH leveling systems:

JUMPER WIRES(UP TO 10 GAUGE)
MULTI-METER
12 VOLT TEST LIGHT

PROCEED WITH THE TROUBLE SHOOTING STEPS ON THE FOLLOWING PAGE



CONTROL IDENTIFICATION

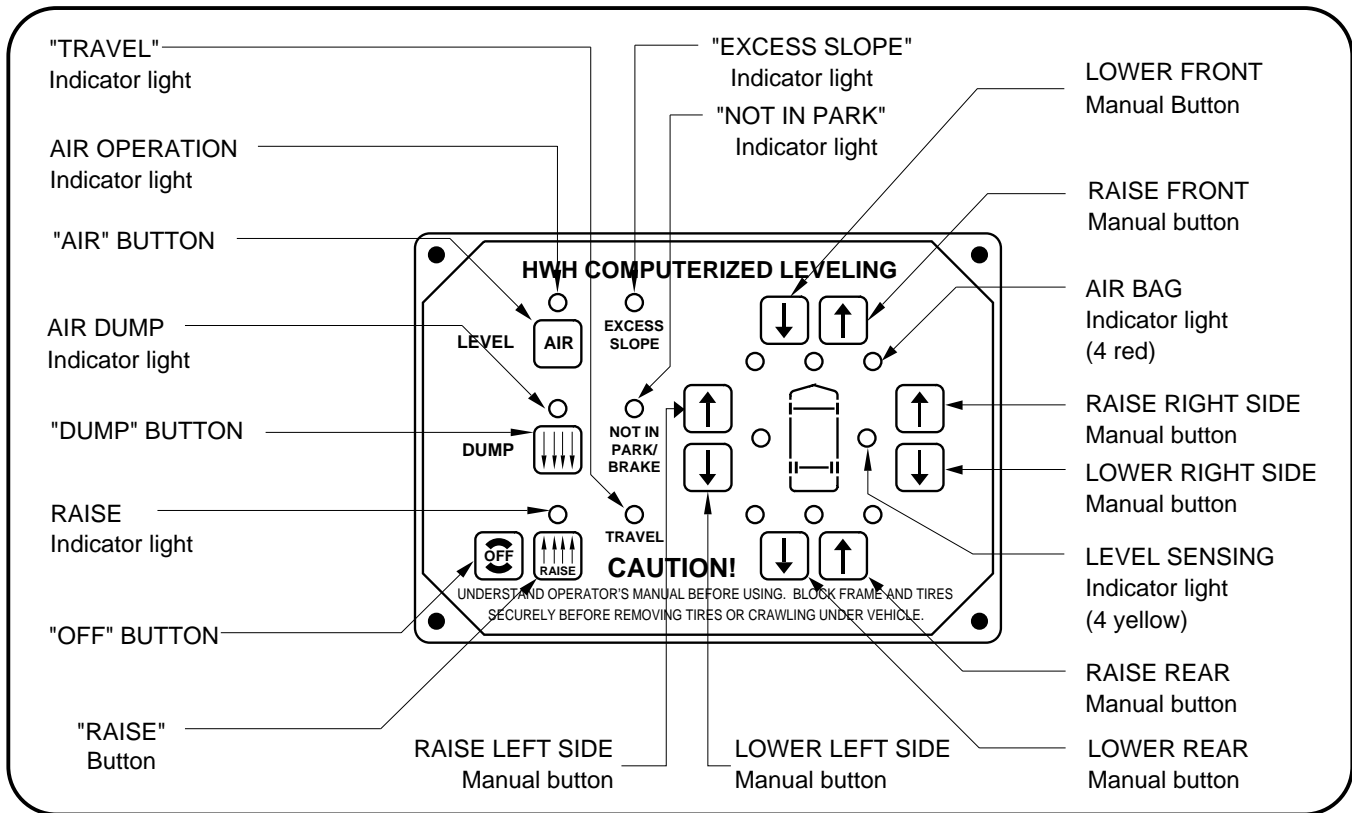

CONTROL FUNCTIONS

CONTROL BUTTONS

"AIR" Button - This button is the system on button and automatic operation button.

"OFF" Button - This button will turn the system OFF but does NOT control power to the "DUMP" or "RAISE" buttons.

"DUMP" Button - This button will lower the whole coach by dumping air from the suspension system.

"RAISE" Button - This button will raise the whole coach by adding air to the suspension system.

UP ARROWS - These are the RAISE manual buttons.

DOWN ARROWS - These are the LOWER manual buttons.

INDICATOR LIGHTS

AIR OPERATION light - This light will be on when the system is on, and flash during automatic leveling.

AIR DUMP light - This light will flash when the "DUMP" button is being pushed.

RAISE light - This light will flash when the "RAISE" button is being pushed.

"EXCESS SLOPE" light - This light will be on if the leveling system can NOT level the coach.

"TRAVEL" light - This light will be on if the leveling system is off and the coach suspension is operable.

AIR BAG lights- These lights will be on when the system is on if the ignition is on. The coach should NOT be moved while these lights are on.

LEVEL SENSING lights- One or two yellow lights can be on indicating that side or end of the coach is low.

"NOT IN PARK/BRAKE" light- This light will be on if the "AIR" button is pushed and the park brake is not set.

TROUBLE SHOOTING STEPS

NOTE: The coach should be at the proper ride height before starting the Trouble Shooting Steps.

1. Make sure the transmission is in the recommended position for parking and the park brake is set. The ignition switch should be in the "OFF" position. If any touch panel lights are on, see Part 1 of the Repair Steps.

2. Turn the ignition switch to "ON". Only the green "TRAVEL" light should be lit. If this is not so, see Part 2 of the Repair Steps.

3. Press the "AIR" button one time. The "ON" indicator light should come on. One or two yellow level indicator lights may come on. The four red AIR BAG indicator lights and the Master Warning Light should be on. The "TRAVEL" light should NOT be on. If this is not correct see Part 3 of the Repair Steps.

4. MANUAL OPERATION: With the system on, the manual up and down arrows should function. These buttons are momentary buttons. Releasing the button will stop the function. Each set of arrows operate pairs of air bags, front, rear, or sides. There are two air manifolds. One for the front air bags and one for the rear air bags. Each manifold has six air solenoid valves. A right and left raise valve, a right and left lower valve and a right and left travel valve. (See MP75.4515). The travel solenoids are tied together electrically in the harnesses and should be on if the ignition is in the "ON" position and the system is off. The front manifold has a right and left air pressure switch. When the pressure in one front air bag drops to approximately 10 psi, the opposite side front air bags will be inhibited from exhausting any more air whether in automatic leveling, pushing a down arrow in manual leveling or pushing the "DUMP" button. The rear manifold has one pressure switch for both sides and will not interfere with the function of the leveling system. The pressure switches complete ground signals. When an up arrow is pushed a +12 signal is sent to the auxiliary air compressor and the corresponding raise solenoid on the air manifolds. The raise valves open the air bags to inflate lifting the coach. The air compressor will only run as the system pressure drops.

When a down arrow is pushed a +12 signal is sent to the corresponding lower solenoids. The lower valves will open allowing the air bags to deflate lowering the coach.

Test each set of up and down arrows checking that the appropriate air bags will inflate and deflate and that the auxiliary compressor will run during the raise function. If there is any malfunction see Part 4 of the REPAIR STEPS.

5. SENSING UNIT CHECK: Using a bubble level inside the coach, level the coach using the up and down arrow buttons. All yellow indicator lights should be off at this time. If not, the sensing unit may need to be adjusted. A yellow light indicates that side or end of the coach is low. Check that all yellow lights can be made to come on (at different times) by raising and /or lowering the ends and sides of the coach. If the ground is too uneven the coach may need to be moved to complete this test. For sensor adjustment procedure see MP85.9505. For sensor testing see Part 5 of the REPAIR STEPS.

From this point on, it is assumed the system is fully functional in the manual mode. Whenever a malfunction occurs, revert to the manual operation and check for correct functioning. If a problem is found in manual operation, trouble shoot the problem using the preceding steps. Remember, low volts can cause erratic performance and damage components.

AUTOMATIC LEVELING

6. Start the coach engine. Set the park brake. Push the "AIR" button one time to turn the system on. Push the "AIR" button a second time. This will start automatic leveling. The following should occur:

- The four red warning lights will be on.
- The indicator light above the "AIR" button will start to flash.
- The master warning light will be on.
- The coach will automatically level itself. The leveling procedure is as follows:

If there are no yellow lights the control box will go directly into a sleep mode.

If there are yellow lights on, leveling will start in a down mode, deflating air bags opposite to lit yellow level indicator lights. After 2 minutes if the coach is not level, the computer will switch to the "UP" mode, inflating air bags according to lit yellow lights. During any raise (UP) function the compressor may run. When all the yellow lights are out, the control box goes into the sleep mode.

SLEEP MODE: After leveling the coach the control box will remain on but inactive for 30 minutes. After 30 minutes the control box will wake up and monitor the yellow lights until leveling is needed. If a light is on or comes on and remains on for 60 seconds, the control box will relevel the coach using the original leveling procedure. After leveling the vehicle the control box will return to the sleep mode.

EXCESS SLOPE: During the leveling mode, either initially or after a sleep mode, if the coach cannot be leveled in 15 minutes the control box will stop all operations, and the "EXCESS SLOPE" indicator will come on. The box will remain on until the "OFF" button is pushed, but will not go into a sleep mode.

If any of the above does not occur, see Part 6 of the REPAIR STEPS.

7. TRAVEL MODE: With the ignition on and leveling system off, the coach should return to the proper travel height. The travel solenoids are energized allowing the height control valves to function. **NOTE:** If the ignition is on and the park brake is released the leveling system should turn off and the coach should return to ride height. If the coach will not return to the proper ride height see part 7 of the REPAIR STEPS.

8. DUMP AND RAISE BUTTONS The "DUMP" AND "RAISE" buttons are for operator convenience. They allow the coach to temporarily be raised or lowered to clear obstacles while moving. These are momentary buttons. When released, the coach will return to ride height if the ignition is on. These buttons will operate with the system on or off, and the ignition on or off. If the system is on, the system will turn off when the button is released. The "DUMP" and "RAISE" button will lower or raise the whole coach. If they are not working correctly see Part 8 of the REPAIR STEPS.

CAUTION: Do not exceed 5 mph or travel long distances when using these buttons or if the coach is not at the proper travel height.

REPAIR STEPS

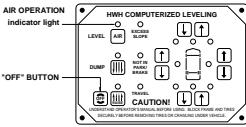
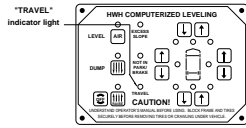
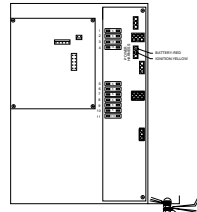
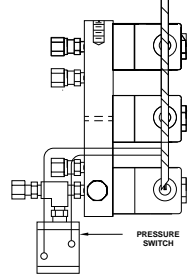
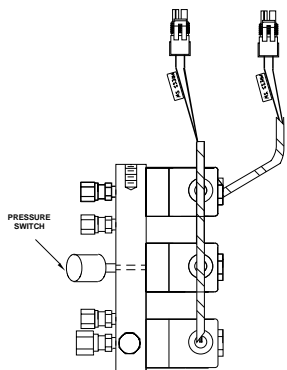
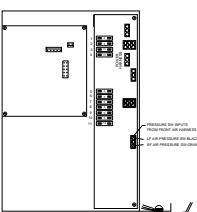
PROBLEM	SOLUTION	FIGURES
<p>Part 1 Touch panel has indicator lights on with the ignition switch off.</p>	<p>If the "ON" indicator light is on, press the "OFF" button. If the "ON" light or any other light remains on, replace the control box. If the "ON" light is not on and any other light is on, replace the control box.</p>	 <p style="text-align: center;">REFER TO MI91.1026 OF SECTION I</p>
<p>Part 2 With the ignition switch on:</p> <p>a. The green "TRAVEL" light nor the master warning light is lit.</p> <p>NOTE: If the vehicle is not equipped with a master warning light, proceed to Part 2b.</p>	<p>Whenever the ignition switch is "ON" one of these lights will be lit but never both at the same time. If neither light is on, check the power to the control box. The (YELLOW) 6110 wire in the power harness will have +12 volts with the ignition in the "ON" position. The (RED) 6100 wire should have +12 volts with the ignition in any position. If the (YELLOW) 6110 wire has power replace the control box. If not, trace the (YELLOW) 6110 wire to its source.</p>	 <p style="text-align: center;">REFER TO MI91.1026 OF SECTION I</p>  <p style="text-align: center;">REFER TO MP85.4510</p>
<p>b. The master warning light is lit and/or the "travel" light is not lit.</p>	<p>With the system off and the ignition in the "ON" position, the master warning light will come on and the "TRAVEL" light will go out if an air bag has low pressure. If the coach is not at the proper ride height start the coach engine and build up air pressure. The master warning light should go out and the "TRAVEL" light should come on as the coach returns to the proper ride height. If the coach will not return to the proper travel height see Section 7 of the TROUBLE SHOOTING STEPS. If the master warning light is lit, the "TRAVEL" light is not on and the coach is at the proper ride height there is a bad pressure switch or a shorted wire for one of the air manifolds.</p> <p>There are two pressure switches on the front manifold and one pressure switch on the rear manifold.</p> <p>Unplug the pressure switch at the rear manifold. If the master warning light goes out and the "TRAVEL" light comes on replace the pressure switch.</p> <p>If the lights do not work properly, unplug either pressure switch on the front manifold. If the lights are correct replace that switch. If the lights are not correct unplug the other pressure switch. If the lights are correct replace that pressure switch. If the lights are still not correct go to the control box. Unplug the front pressure switch harness. If the lights are correct the problem is in the harness. If the lights are not correct, unplug the rear air harness. If the lights are correct the (YELLOW) 3215 wire in the harness is shorted to ground. If the lights still are not correct, replace the control box.</p>	 <p style="text-align: center;">REFER TO MP75.4520</p>  <p style="text-align: center;">REFER TO MP75.4515</p>  <p style="text-align: center;">REFER TO MP85.4510</p>

REPAIR STEPS

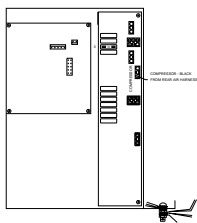
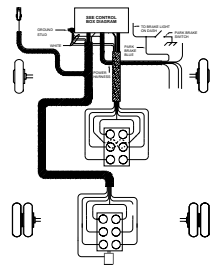
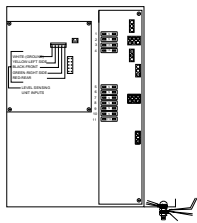
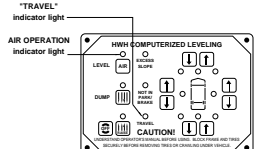
PROBLEM	SOLUTION	DIAGRAMS
<p>Part 3 After pushing the "AIR" button one time:</p> <p>a. The system will not turn on and no lights except the TRAVEL light are on.</p>	<p>Check the battery fuse. If it is not blown the control box, touch panel, or cable is bad. If the battery fuse is blown, replace the fuse, unplug the compressor wire then press the "AIR" button again. If the fuse blows again replace the control box. If the fuse does not blow and the system turns on, the compressor wire is probably shorted to ground.</p>	<div style="text-align: right;">  <p style="font-size: small;">COMPRESSOR WIRE TRAVEL LIGHT INDICATOR</p> </div> <p style="text-align: center;">REFER TO MP85.4510</p>
<p>b. All of the panel lights come on and stay on.</p>	<p>The microprocessor is bad. Replace the control box.</p>	
<p>c. The on indicator light will not stay on and the NOT IN PARK/BRAKE light comes on while the "AIR" button is being pushed.</p>	<p>Make sure the park brake is set. Check for a ground on the (BLUE) 9000 Park/Brake Sensor wire. If a ground is present, replace the control box. If a ground is not present trace the (BLUE) 9000 wire and check its connection. Check the park brake switch.</p>	<div style="text-align: right;">  </div> <p style="text-align: center;">REFER TO MP85.453F</p>
<p>d. Opposite yellow lights come on.</p>	<p>Unplug the sensing unit cable. There are five pins. The pin for the white wire is the ground for the sensing unit. The other four pins are for the front, rear, left and right side yellow lights. Ground each individual pin. Only one light should come on per pin. If more than one light comes on, replace the control box. If only one light comes on, replace the sensing unit.</p>	<div style="text-align: right;">  </div> <p style="text-align: center;">REFER TO MP85.4510</p>
<p>e. With the "ON" indicator light lit, the TRAVEL light will not go out.</p>	<p>The travel light should not be on when the system is on. Replace the control box.</p>	<div style="text-align: right;">  <p style="font-size: x-small;">"TRAVEL" indicator light AIR OPERATION indicator light</p> </div> <p style="text-align: center;">REFER TO MI91.1026 OF SECTION I</p>

REPAIR STEPS

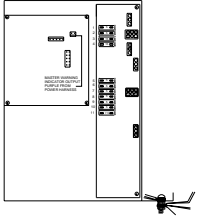
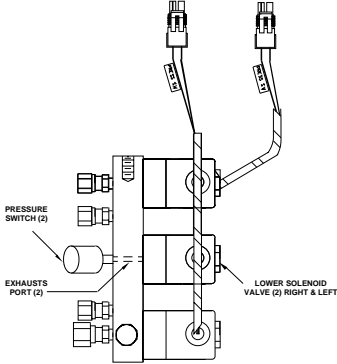
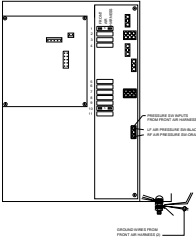
PROBLEM	SOLUTION	DIAGRAMS
<p>Part 3 continued</p> <p>f. The master warning light is not on.</p>	<p>The (PURPLE) 7699 wire from the master warning indicator output should be a ground when the the system is on and the ignition is in the "ON" position. If not, replace the control box. If power is present, check the (PURPLE) 7699 wire at the light. Check the ground for the light or replace the bulb.</p>	 <p>REFER TO MP85.4510</p>
<p>Part 4 When pushing an up or down arrow:</p> <p>NOTE: The coach should be at proper ride height when testing down arrows.</p> <p>a. A front bag will not deflate when pushing a front or side down arrow.</p>	<p>Check that the exhaust ports of the air manifold are not plugged.</p> <p>Check the corresponding fuse for the bag that is not exhausting air. If the fuse is blown, the valve or the wire to the valve is shorted to ground. If the fuse is not blown, check the corresponding pin in the box for the valve.</p> <p>If power is not present. Unplug the opposite front pressure switch and retry. If power is not present replace the control box. (Check that the pressure switch wires are not shorted to ground). If power is present the pressure switch that is unplugged is closed. If there is more than 20 psi in the air bag the pressure switch should be replaced.</p> <p>If power is present on the pin. With the pressure switch wires plugged in, the problem is the wire to the valve, the ground for the valve, or the valve. Check for power in the harness plug. If it is a 2 - wire plug check between the two pins in the plug. If it is a 1 - wire plug, check between the plug and ground. If power is present check the ground for the solenoid if it is a 1 - wire plug. Replace the valve if power is present and the ground is OK. If a 2 - wire plug is used the white wire is ground. Check for power between the (colored) black wire and a frame member. If power is present repair the ground wire. If power is not present repair the (colored) black wire.</p>	 <p>REFER TO MP75.4515</p>  <p>REFER TO MP85.4510</p>

REPAIR STEPS

PROBLEM

SOLUTION

DIAGRAMS

Part 4 continued

b. A rear bag will not deflate when pushing a rear or side down arrows.

The pressure switch will not interfere when deflating the rear air bags. Check the fuse for the appropriate lower solenoid valve. If the fuse is blown the solenoid valve or the power wire for the solenoid valve is shorted.

If the fuse is not blown check for power on the corresponding pin in the control box. If power is not present, replace the control box. If power is present on the pin, the problem is the wire to the valve, the ground for the valve, or the valve. Check for power in the harness plug. If it is a 2 - wire plug check between the two pins in the plug. If it is a 1 - wire plug check between the plug and ground. If power is present check the ground for the solenoid if it is a 1 - wire plug. Replace the valve if power is present and the ground is OK. If power is not present a wire or connection is bad. If a 2-wire plug is used the white wire is ground. Check for power between the (colored) black wire and a frame member. If power is present repair the ground wire. If power is not present repair the (colored) black wire.

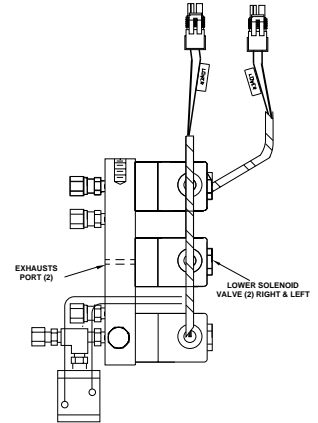

REFER TO MP75.4515

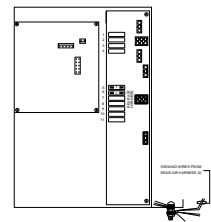

REFER TO MP85.4510

c. Diagonal air bags deflate or inflate when a side arrow is pushed.

If diagonal bags such as left front and right rear deflate or inflate when a side arrow is pushed the wiring or plumbing connection are switched. Check the diagrams and redo connections according to the diagrams.

REFER TO MP75.450D

REFER TO MP85.453F

REPAIR STEPS

PROBLEM

SOLUTION

DIAGRAMS

Part 4 continued

d. Air bags will not inflate when an up arrow is pushed.

Check the appropriate fuse for that raise solenoid valve. If the fuse is blown the valve, or the power wire to the valve is shorted.

If the fuse is not blown check for power on the corresponding pin in the control box. If power is not present, replace the control box. If power is present on the pin, the problem is the wire to the valve, the ground for the valve, or the valve. Check for power in the harness plug. If it is a 2 - wire plug check between the two pins in the plug. If it is a 1 - wire plug check between the plug and ground. If power is present check the ground for the solenoid if it is a 1 - wire plug. Replace the valve if power is present and the ground is OK. If power is not present a wire or connection is bad. If a 2-wire plug is used the white wire is ground. Check for power between the (colored) black wire and a frame member. If power is present repair the ground wire. If power is not present repair the (colored) black wire.

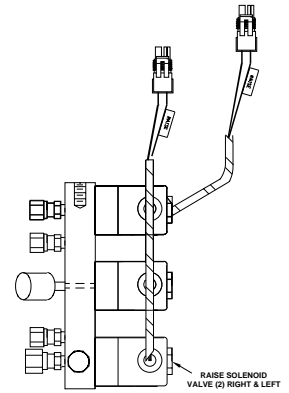

REFER TO MP75.4515

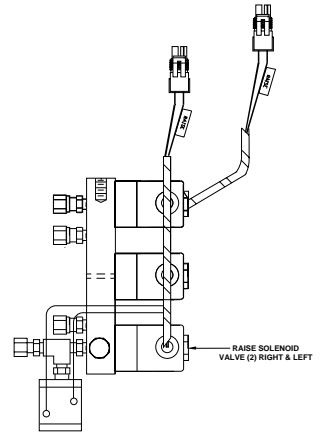

REFER TO MP75.4520

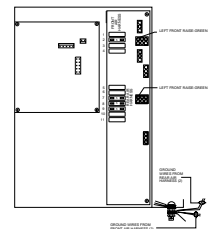

REFER TO MP85.4510

REPAIR STEPS

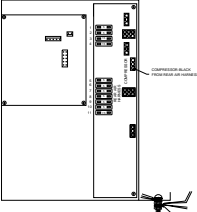
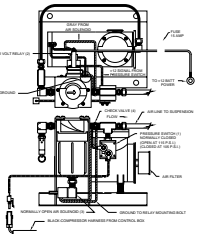
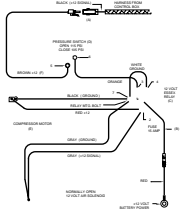
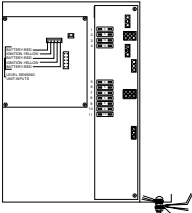
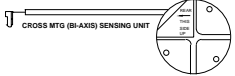
PROBLEM	SOLUTION	DIAGRAMS
<p>Part 4 continued</p> <p>e. The compressor will not run when pushing up arrow.</p> <p>NOTE: If the air system is fully pressurized, the compressor should not run. Pumping the brake pedal several times will reduce pressure in the system allowing the compressor to run.</p>	<p>The (BLACK) 9700 wire for the air compressor is in the rear air manifold harness. It goes to the 3 pin compressor plug in the box. When an up arrow is pushed, there should be +12 power on this wire.</p> <p>Check the corresponding pin in the box. If +12 is not present replace the control box.</p> <p>NOTE: There is no fuse for the compressor wire. The power comes from the battery fuse in the control box. If the battery fuse is blown the system will not turn on.</p> <p>If +12 compressor power is present at the control box, check for power at the compressor. The compressor harness plug (A) should have +12 power when an up arrow is pushed. If not the wire is bad. If power is present check the +12 battery power (B) at terminal 1 of the 12 volt relay (C) on the compressor assembly. That wire should be fused. If there is no power check the fuse, the wire, the connections and the source. If there is power to the relay and the compressor will not run, the problem is the pressure switch (D), the relay (C) or the compressor motor (E).</p> <p>Jump power from terminal 1 to Terminal 2. If the compressor does not run, check the ground connections at terminal 7. If OK the compressor should be replaced. If the compressor does run, jump power from terminal 1 to terminal 3, If the compressor does not run check the ground for terminal 4. If OK, replace the relay (C). If the compressor runs, check for power at Terminal 5. If power is not present, the short brown lead (F) or the connection to the compressor harness (A) is bad. If power is present, replace the pressure switch. (D).</p>	 <p>REFER TO MP85.4510</p>  <p>REFER TO MP75.4525</p>  <p>REFER TO MP85.4525</p>
<p>Part 5 Yellow level indicator lights, will not work properly.</p>	<p>Unplug the sensing unit from the control box. Connect the test light to +12. The pin for the white wire of the sensing unit is a ground. Check the pin with the test light. If a ground is not present, replace the control box, If ground is present, connect the test light to ground. Touch the four pins for the color coded wire. Each pin will light one yellow light. If this is so, the problem is the sensing unit. If not, replace the control box.</p> <p>Check that the sensing unit is mounted correctly according to the sticker on the sensing unit.</p>	 <p>REFER TO MP85.4510</p>  <p>REFER TO MP85.9505</p>

REPAIR STEPS

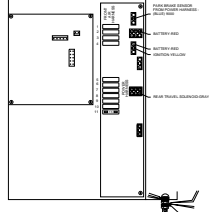
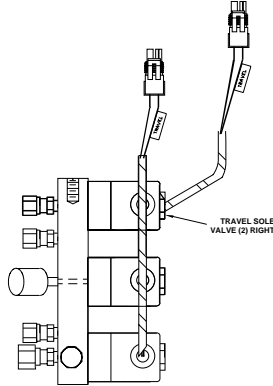
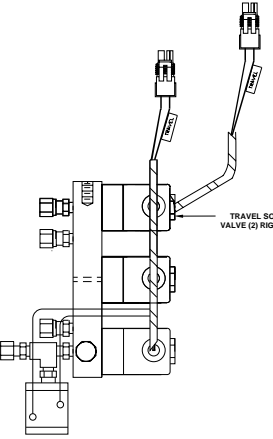
PROBLEM	SOLUTION	DIAGRAMS
AUTOMATIC LEVELING		
<p>Part 6 After pushing the "AIR" button twice the system will not level properly.</p>	<p>If the system will not function properly in the automatic mode, check steps 1 thru 5. If the system works manually, replace the control box. Remember low voltage situations and poor ground connections will cause erratic leveling.</p>	
<p>Part 7 The coach will not return to the proper travel height with the ignition on and the system off.</p>	<p>Check the fuse for the travel solenoids. A blown fuse indicates a shorted wire or solenoid valve. Unplug one air harness at a time to determine which wire or manifold is shorted. Then unplug the travel solenoid to determine a bad wire or valve.</p> <p>If the fuse is not blown, check the corresponding pins in the control box for the travel solenoids. If +12 power is not present, replace the control box. If power is present check for power at the manifolds. Then replace the solenoid valve for any bag that will not reinflate.</p>	 <p style="text-align: center;">REFER TO MP85.4510</p>  <p style="text-align: center;">REFER TO MP75.4515</p>  <p style="text-align: center;">REFER TO MP75.4520</p>
<p>The system will not shut off if the park brake is released.</p>	<p>With the system on, the ignition on and the park brake released, unplug the park brake connection from the control box. If the system remains on, replace the control box. If the system turns off, there is a constant ground on the park brake wire. Check that the park brake wire is properly connected to the park brake switch and that the park brake switch is working properly.</p>	
<p>Part 8 The coach will not raise or lower when using the "RAISE" and "DUMP" button.</p> <p>The coach will not return to travel height when the button is released.</p>	<p>These buttons are extensions of the up and down arrows. Check Part 4 a, b, and d of this section. If these function properly replace the control box or touch pad.</p> <p>Recheck Part 7 of this section. If it is OK there may be a problem with the height control valves.</p>	

AIR LINE CONNECTION DIAGRAM

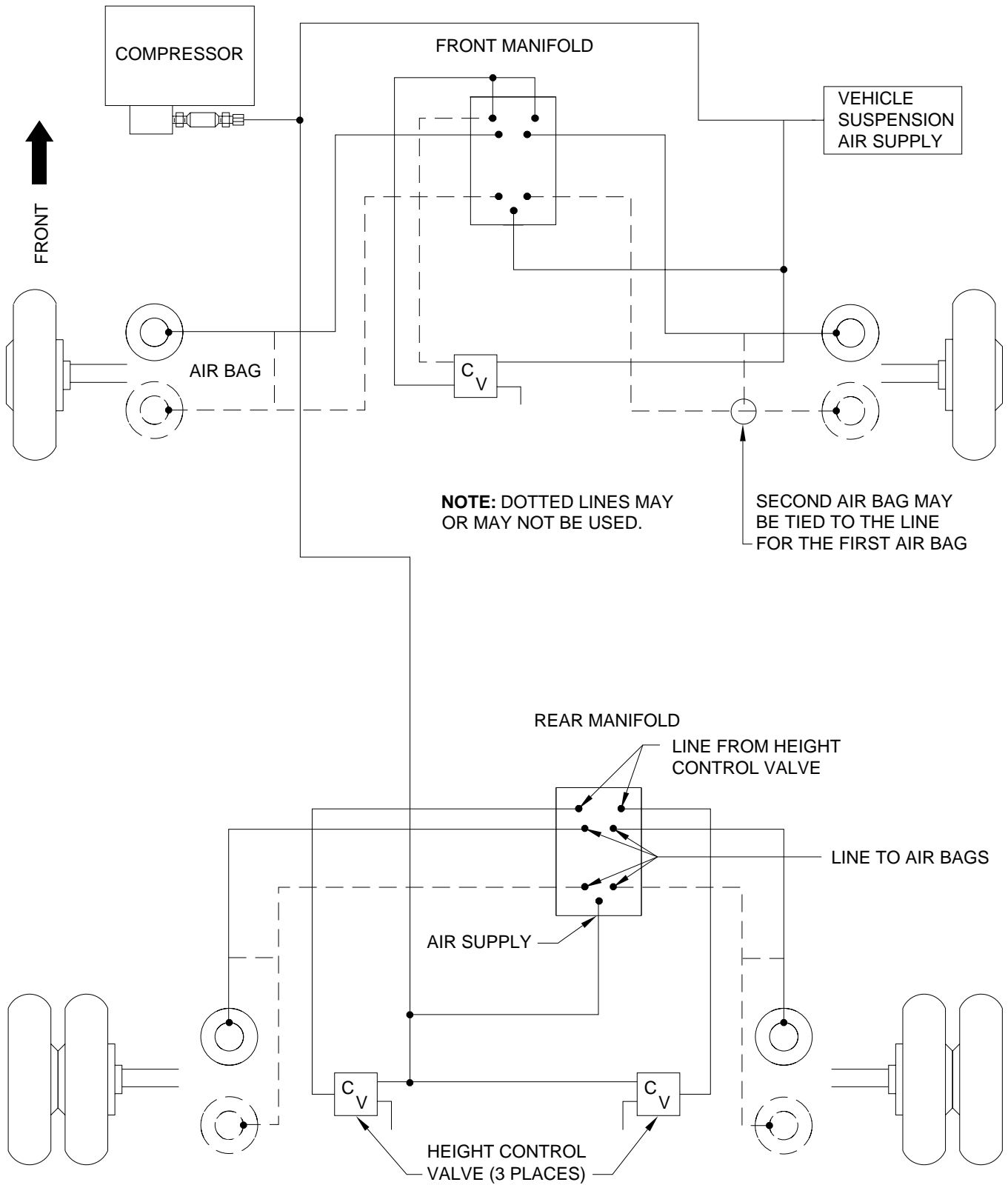

MANIFOLDS ARE MOUNTED TO MAIN CROSS MEMBERS. LEAVE AMPLE CLEARANCE FOR CONNECTION OF HOSES TO FITTINGS.

AIR LEVEL SCHEMATIC

4-POINT LEVELING W/AIR COMPRESSOR

PRESSURE SWITCHES FRONT AND REAR

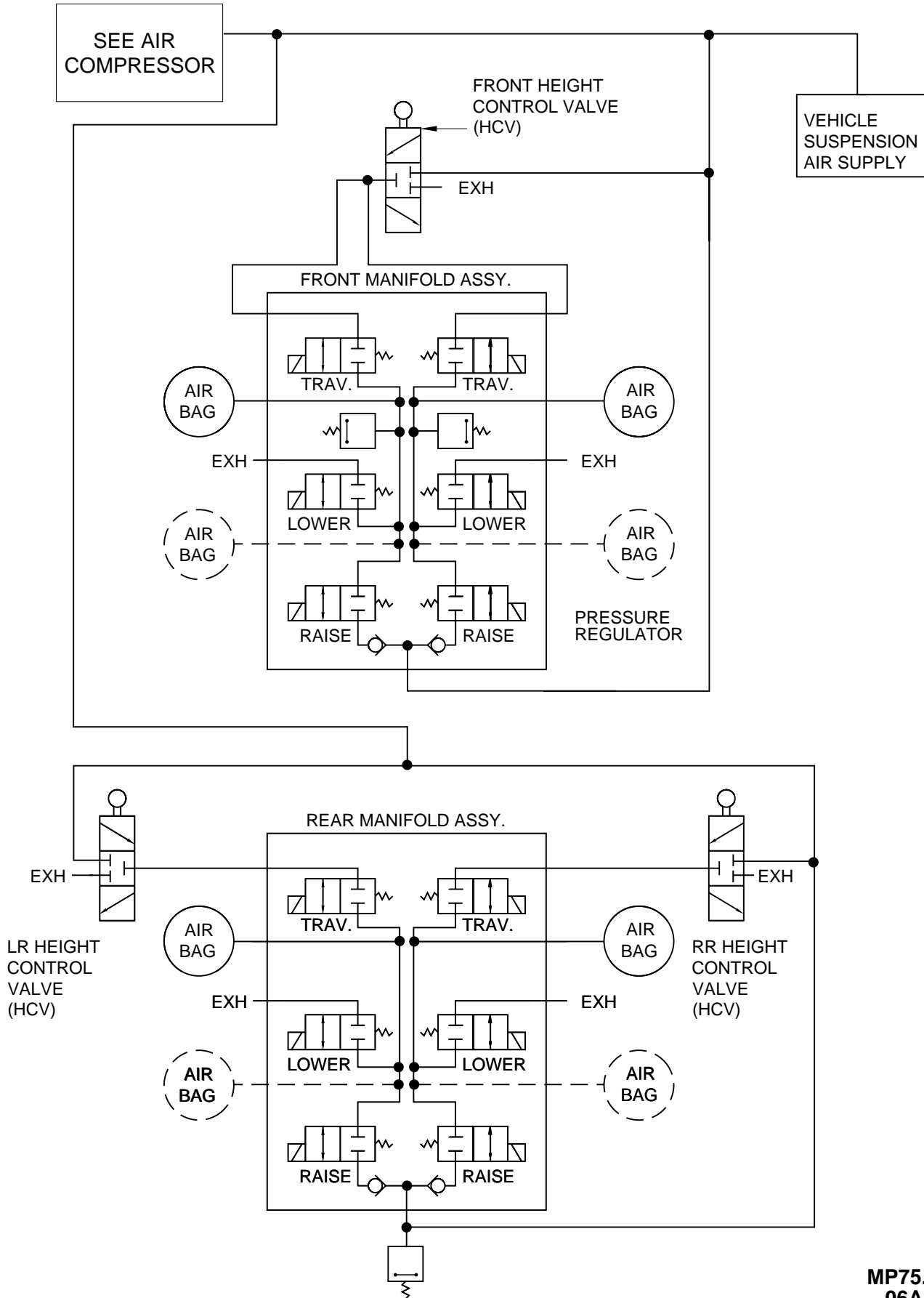

AIR SOLENOID MANIFOLD 6 VALVE WITH TWO PRESSURE SWITCHES

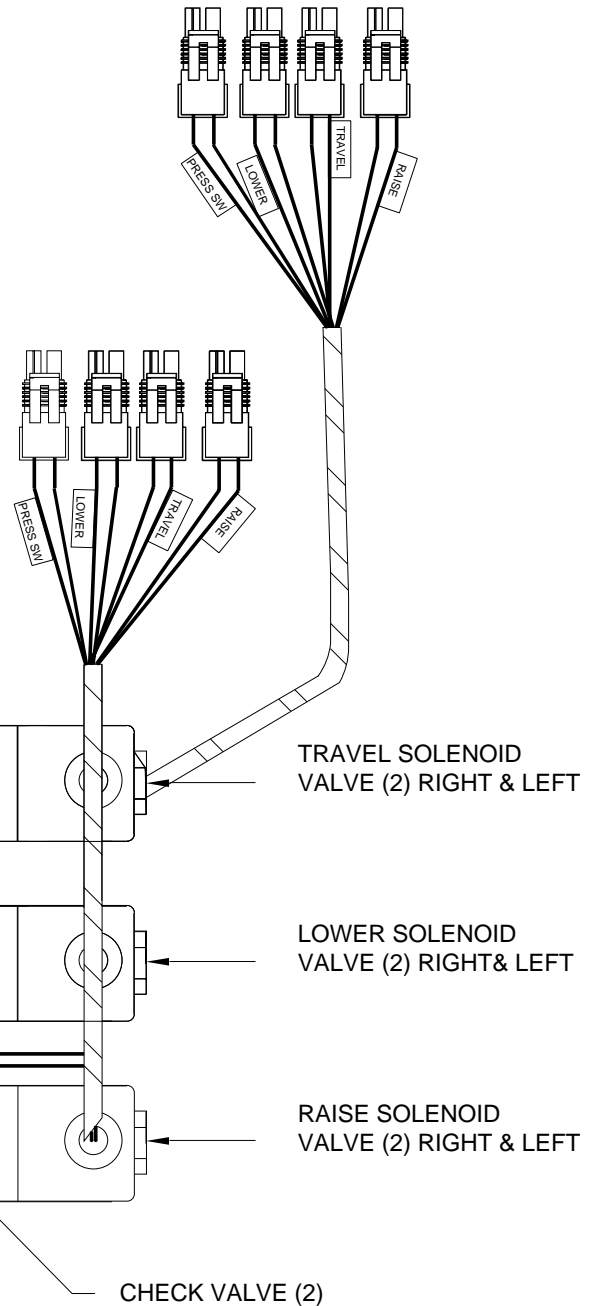
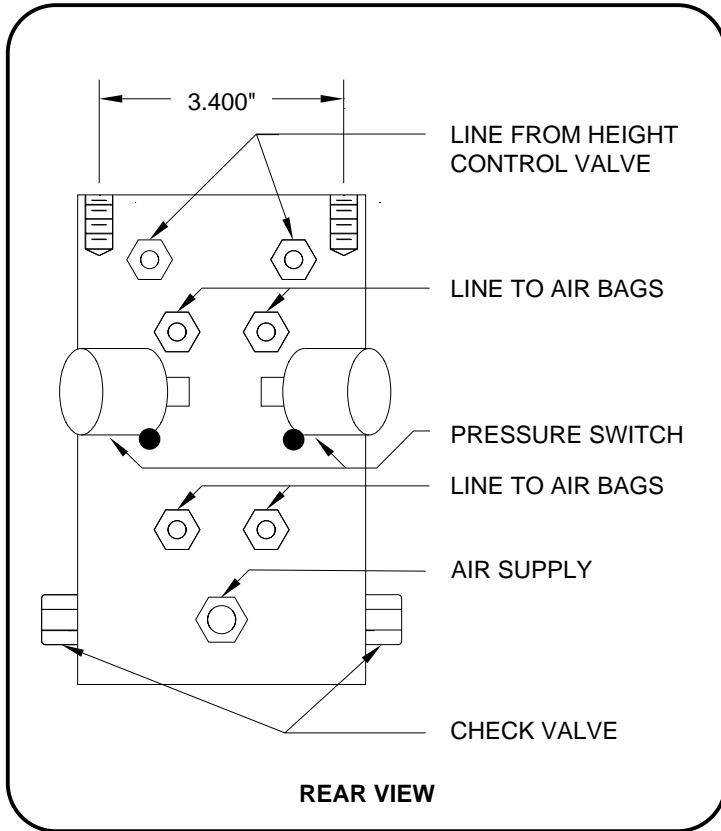

AIR SOLENOID MANIFOLD 6 VALVE WITH ONE PRESSURE SWITCH

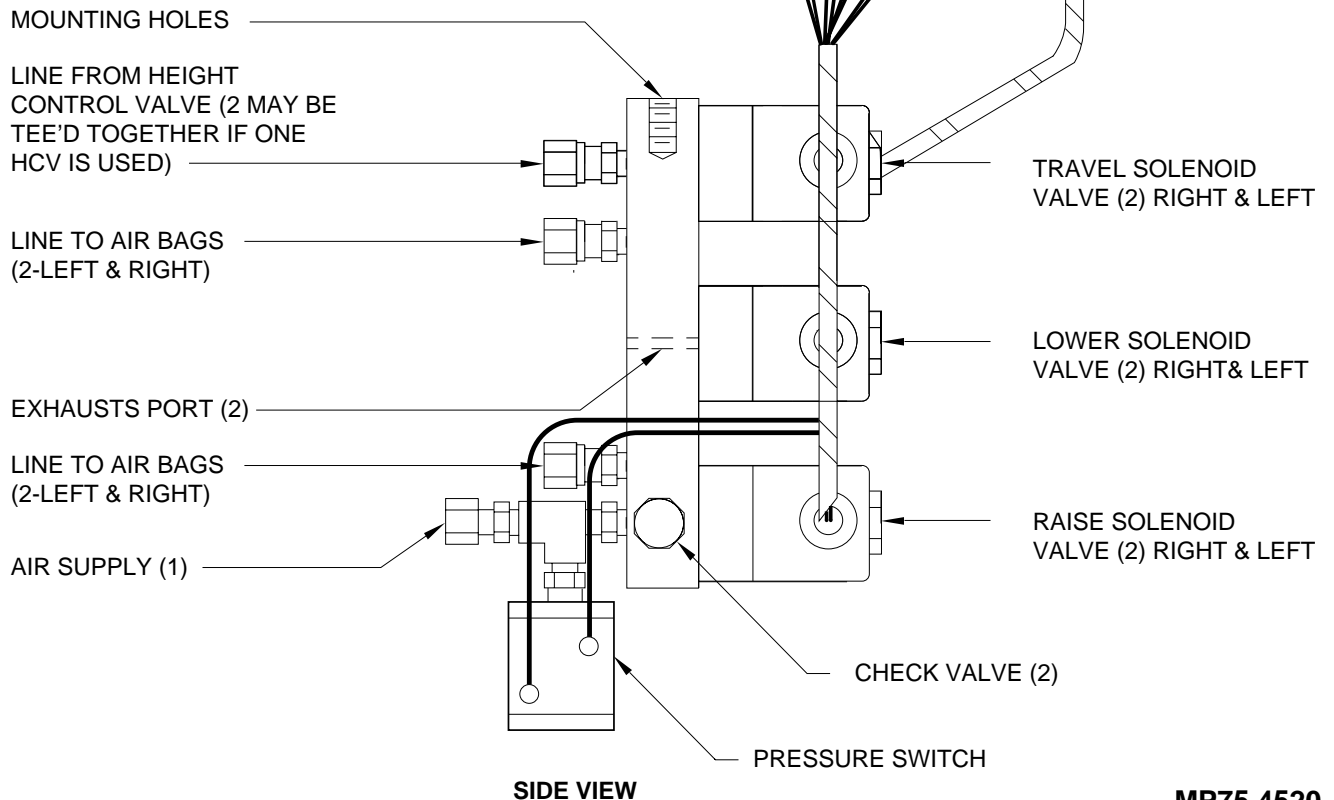
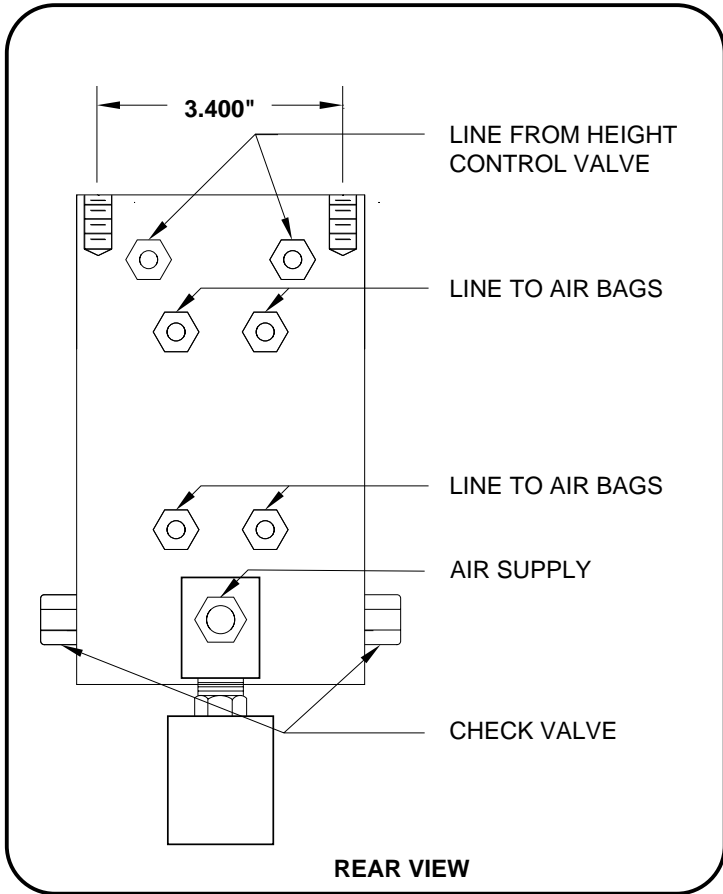

COMPRESSOR DIAGRAM

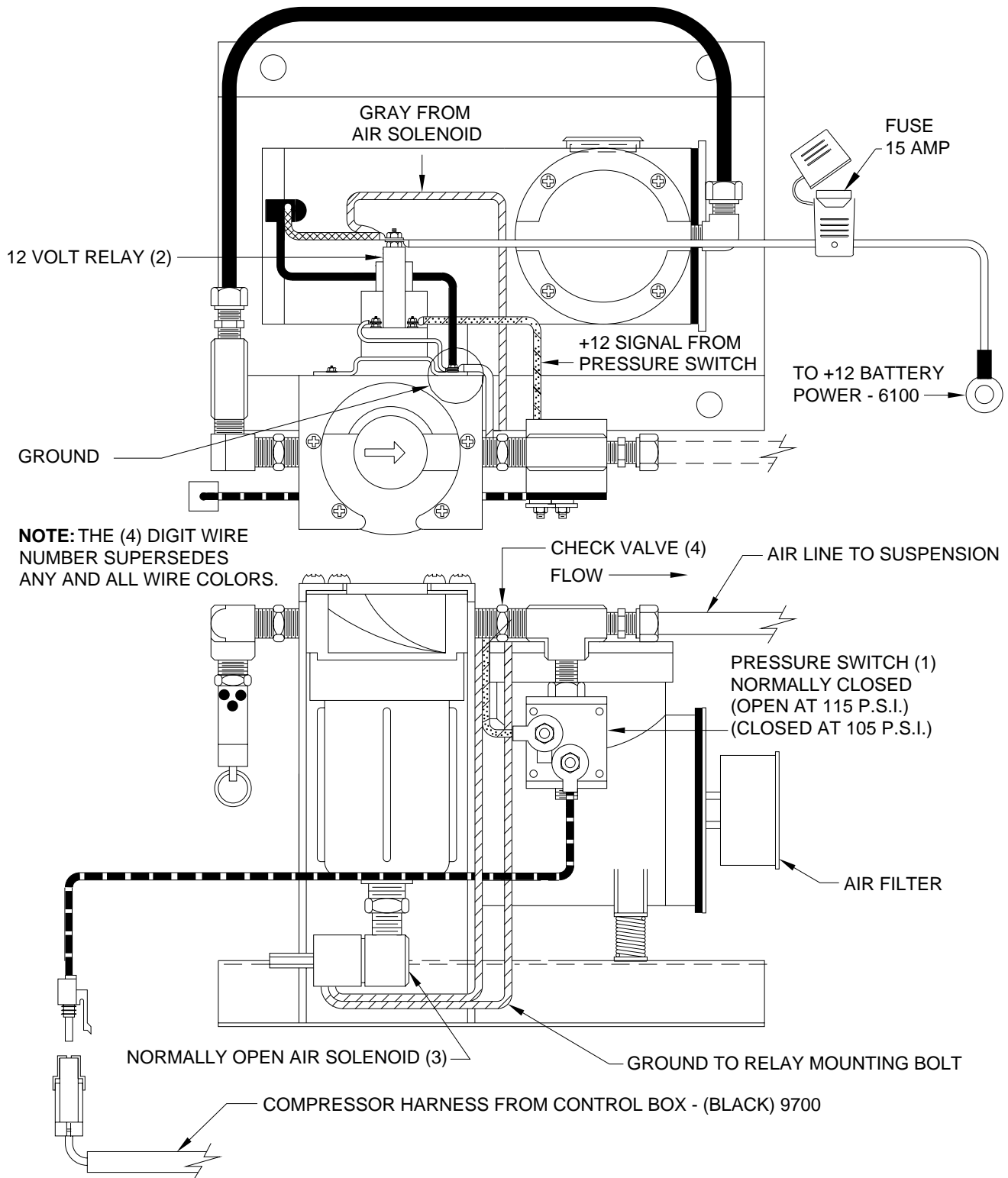

The control box sends a +12 signal to the normally closed pressure switch (1). If the pressure is low, the 12 volt relay (2) will energize and the compressor will run. The normally open air solenoid (3) will close allowing the compressor to build pressure. When the pressure builds to 115 P.S.I. the pressure switch will open, stopping the air compressor.

The normally open air solenoid (3) will open, allowing internal pressure & moisture to bleed off. The check valve (4) will keep the suspension air from bleeding back to the compressor. As air pressure drops below 105 P.S.I. the compressor will start.

MP75.4525
03FEB99

600 SERIES CONTROL BOX CONNECTION DIAGRAM 4-POINT AIR LEVELING

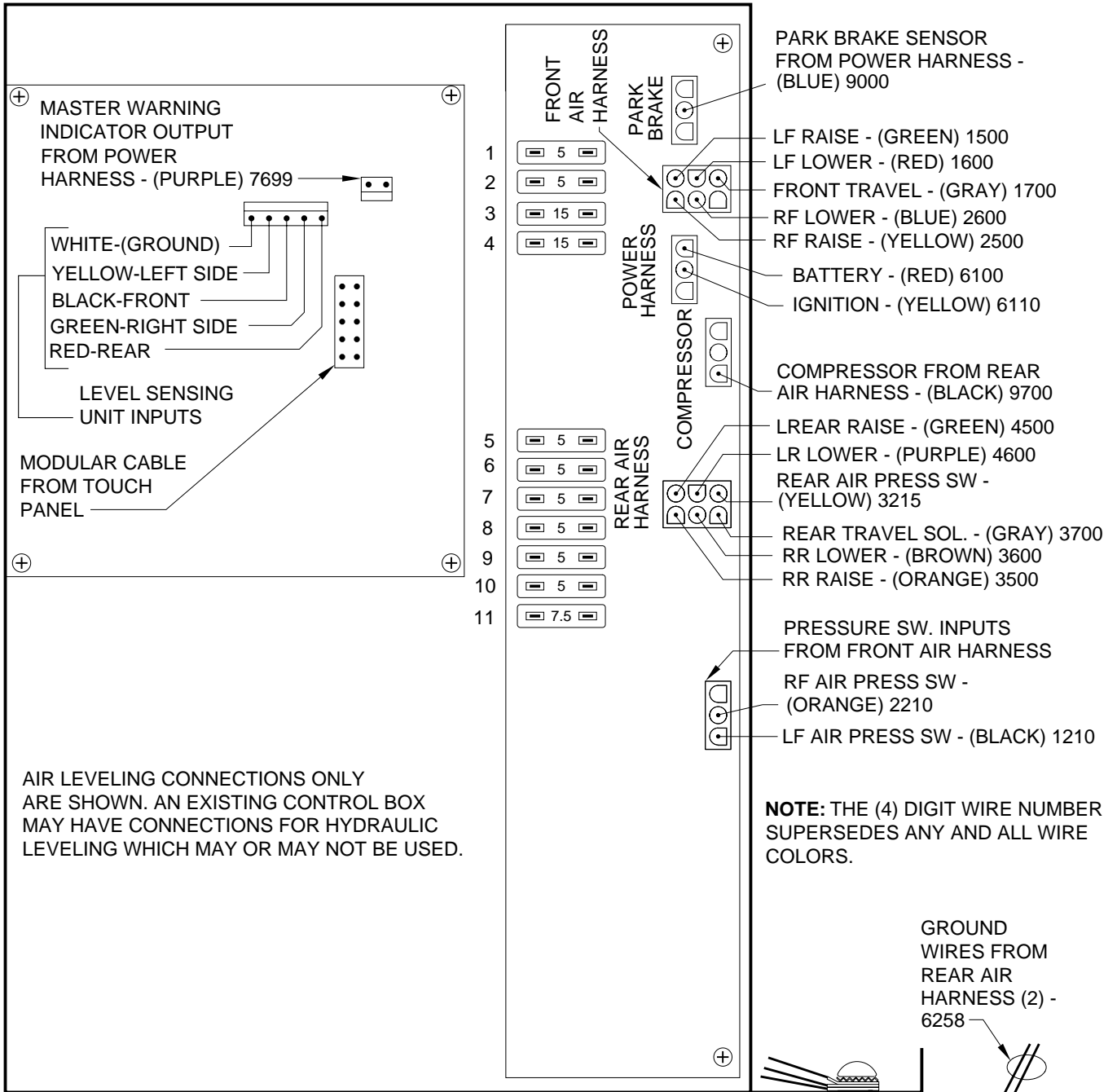

FUSE DESIGNATION

- 1 RIGHT FRONT LOWER
- 2 RIGHT FRONT RAISE
- 3 BATTERY
- 4 IGNITION
- 5 RIGHT REAR LOWER
- 6 LEFT REAR LOWER
- 7 LEFT REAR RAISE
- 8 RIGHT REAR RAISE
- 9 LEFT FRONT RAISE
- 10 LEFT FRONT LOWER
- 11 TRAVEL

#10 WHITE WIRE FROM POWER HARNESS - (WHITE) 6230

GROUND WIRES FROM FRONT AIR HARNESS (2) - 6254

GROUND WIRES FROM REAR AIR HARNESS (2) - 6258

ELECTRICAL CONNECTION DIAGRAM AIR COMPRESSOR

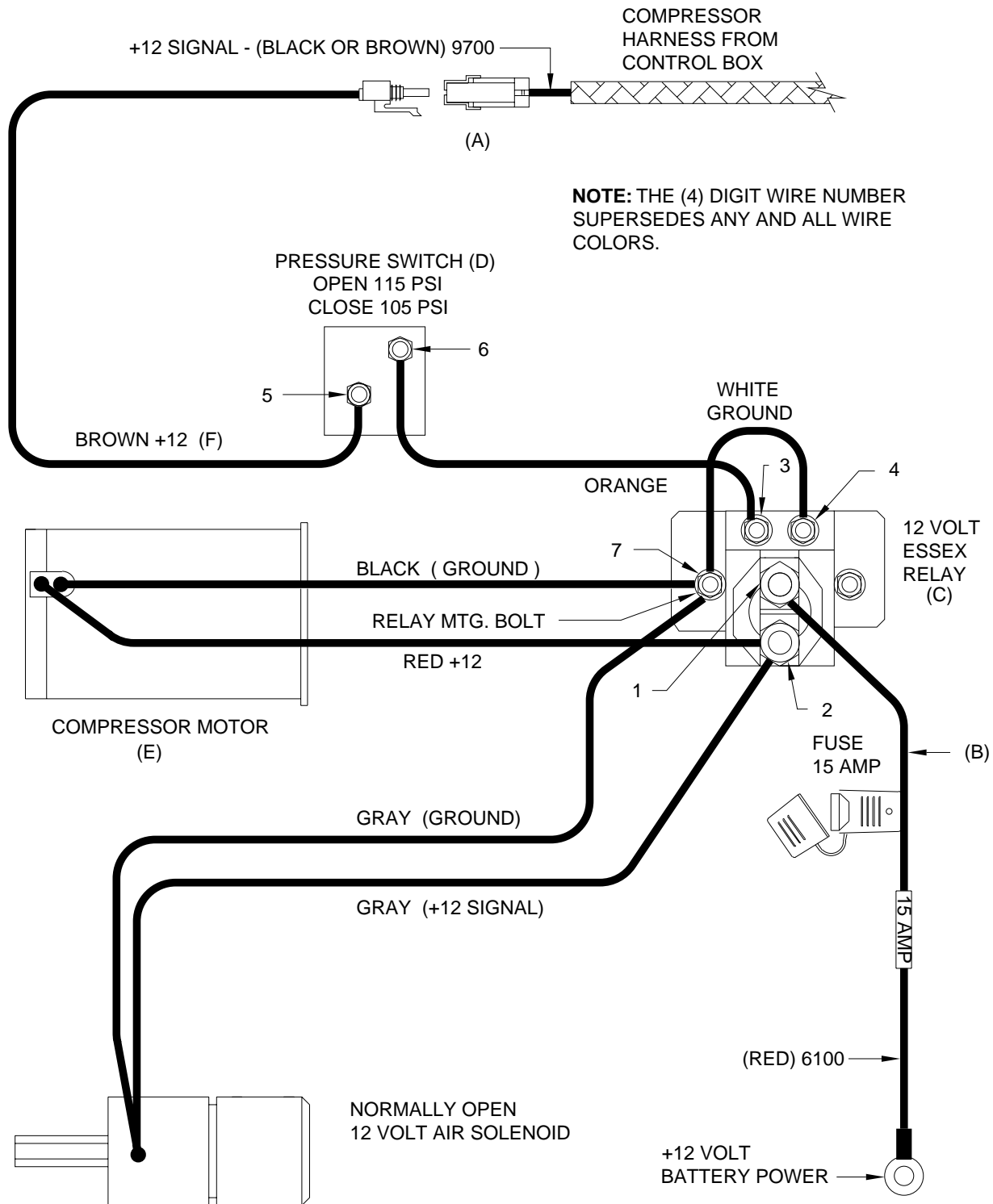

ELECTRICAL CONNECTION FOR AIR LEVELING SYSTEM WITH TOUCH PANEL CONTROL

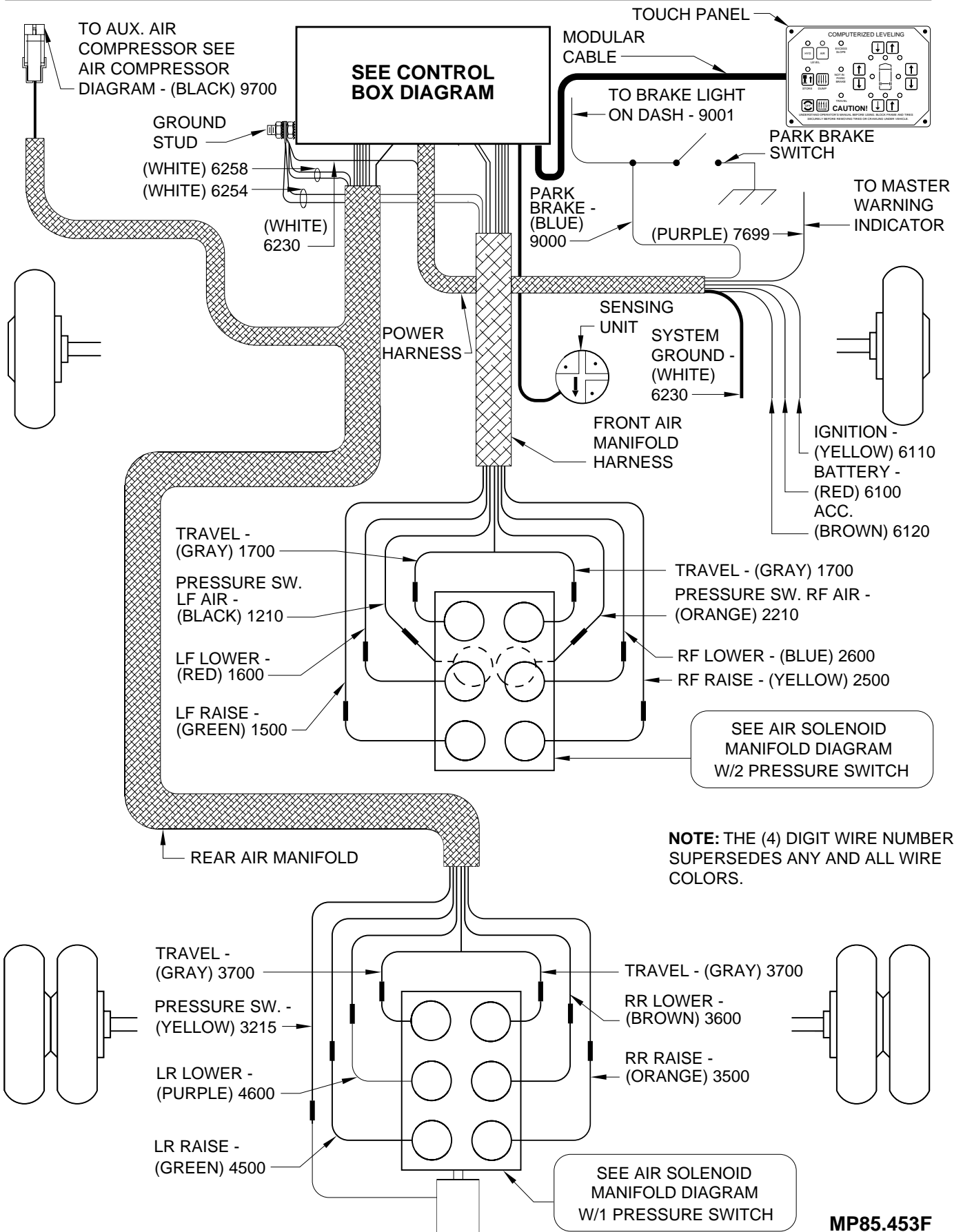

NOTE: THE (4) DIGIT WIRE NUMBER SUPERSEDES ANY AND ALL WIRE COLORS.

MOUNTING AND ADJUSTMENT INSTRUCTIONS

LEVEL SENSING UNIT

The sensing unit must be mounted to a solid surface and must not be exposed to any heat sources. Toward the middle of the vehicle but outside the frame rails is best. The sensing unit may be mounted between frame rails on pusher vehicles and trailers. The sensing unit may be mounted in a compartment but needs to be protected from stored objects. It is critical that the sensing unit is mounted in the proper position according to the sticker on the sensing unit. (See figure below). The springs should be compressed to approximately 1.25 inches.

The correct method for adjusting the sensor is as follows:

First, level the vehicle by placing a 24" level in the center of the vehicle on the floor. With the vehicle level adjust the sensing unit until all yellow lights are out. This is done by drawing up or backing out the sensing unit screws. If a front light is on, adjust the front screw. If a side light is on adjust the side screw. If a rear light is on adjust the rear screws. One or more screws may have to be adjusted to turn the yellow lights out. After adjustment has been made, pull down on the sensing unit to make sure the unit is bottomed out on the screw heads. Check to make sure all yellow lights are out. If not, readjust. Rock the vehicle and recheck for yellow lights, readjust if needed.

NOTE: The sensing unit has an accuracy tolerance of +/- 1" side to side and +/- 5.4" front to rear on a 36' vehicle.

