



OPERATOR'S MANUAL

HWH® COMPUTER-CONTROLLED 625 SERIES LEVELING SYSTEM

FEATURING:

*Touch Panel Leveling Control
BI-AXIS® Hydraulic Leveling
Kick-Down Jacks*

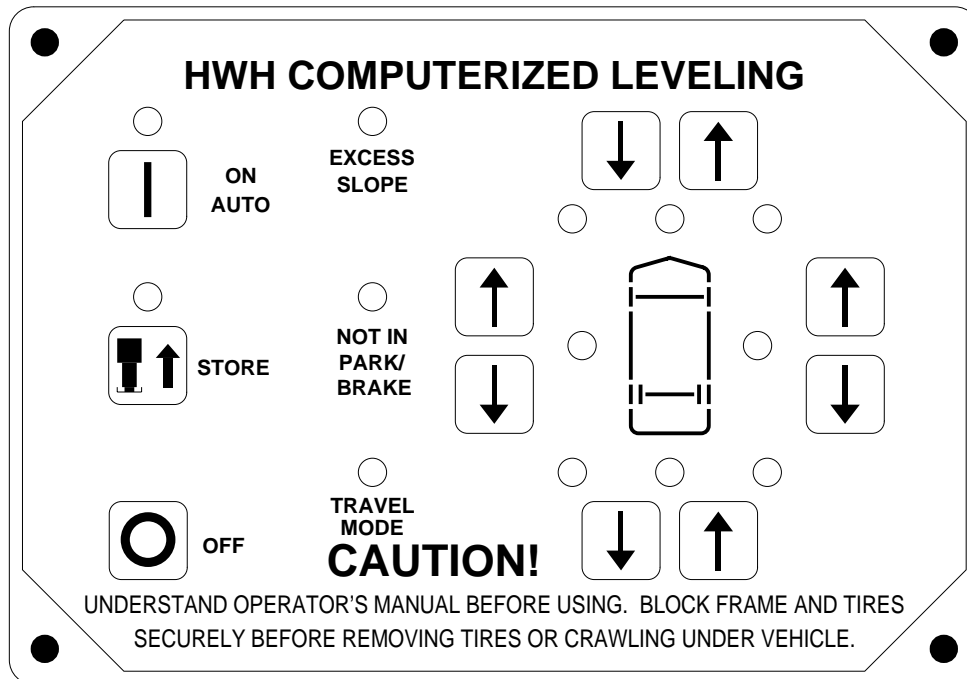

HWH CORPORATION

(On I-80, Exit 267 South)

2096 Moscow Road | Moscow, Iowa 52760

Ph: 800/321-3494 (or) 563/724-3396 | Fax: 563/724-3408

www.hwh.com

AP28847 - U.S.
AP34633 - Europe

ML30288/MP05.6004
09JUN05

OPERATOR'S MANUAL

CAUTION !

READ THE ENTIRE OPERATOR'S MANUAL BEFORE OPERATING.

BLOCK FRAME AND TIRES SECURELY BEFORE CRAWLING UNDER VEHICLE. DO NOT USE LEVELING JACKS OR AIR SUSPENSION TO SUPPORT VEHICLE WHILE UNDER VEHICLE OR CHANGING TIRES. VEHICLE MAY DROP AND OR MOVE FORWARD OR BACKWARD WITHOUT WARNING CAUSING INJURY OR DEATH.

KEEP ALL PEOPLE CLEAR OF THE VEHICLE WHILE LEVELING SYSTEM AND ROOM EXTENSIONS ARE BEING OPERATED.

KICK-DOWN JACKS MAY ABRUPTLY SWING UP WHEN THE FOOT OF THE JACK CLEARS THE GROUND OR WHEN THE JACK REACHES FULL EXTENSION.

NEVER PLACE HANDS OR OTHER PARTS OF THE BODY NEAR HYDRAULIC LEAKS. OIL MAY PENETRATE THE SKIN CAUSING INJURY OR DEATH.

WEAR SAFETY GLASSES WHEN INSPECTING OR SERVICING THE SYSTEM TO PROTECT EYES FROM DIRT, METAL CHIPS, OIL LEAKS, ETC. FOLLOW ALL OTHER APPLICABLE SHOP SAFETY PRACTICES.

IF THE VEHICLE IS EQUIPPED WITH KICK-DOWN STYLE JACKS, DO NOT OVER EXTEND THE REAR JACKS. IF THE WEIGHT OF THE VEHICLE IS REMOVED FROM ONE OR BOTH REAR WHEELS, THE VEHICLE MAY ROLL FORWARD OR BACKWARD OFF OF THE JACKS.

NOTE: KEEP THE CONTROL VALVE LEVERS IN THE STORE POSITION WHEN JACKS ARE NOT IN USE.

IMPORTANT: IF VEHICLE IS EQUIPPED WITH A ROOM EXTENSION, READ ROOM EXTENSION SECTION BEFORE OPERATING LEVELING SYSTEM.

HOW TO OBTAIN WARRANTY SERVICE

THIS IS NOT TO BE INTERPRETED AS A STATEMENT OF WARRANTY

HWH CORPORATION strives to maintain the highest level of customer satisfaction. Therefore, if you discover a defect or problem, please do the following:

FIRST: Notify the dealership where you purchased the vehicle or had the leveling system installed. Dealership management people are in the best position to resolve the problem quickly. If the dealer has difficulty solving the problem, he should immediately contact the Customer Service Department, at HWH CORPORATION.

SECOND: If your dealer cannot or will not solve the problem, notify the Customer Service Department:
HWH CORPORATION 2096 Moscow Rd. Moscow IA. 52760
(563) 724-3396 OR (800) 321-3494. Give your name and address, coach manufacturer and model year, date the coach was purchased, or the date of system installation,

description of the problem, and where you can be reached during business hours (8:00 a.m. till 5:00 p.m. c.s.t.). HWH CORPORATION personnel will contact you to determine whether or not your claim is valid. If it is, HWH CORPORATION will authorize repair or replacement of the defective part, either by appointment at the factory or by the authorization of an independent service facility, to be determined by HWH CORPORATION. All warranty repairs must be performed by an independent service facility authorized by HWH CORPORATION, or at the HWH CORPORATION factory, unless prior written approval has been obtained from proper HWH CORPORATION personnel.

CONTROL IDENTIFICATION

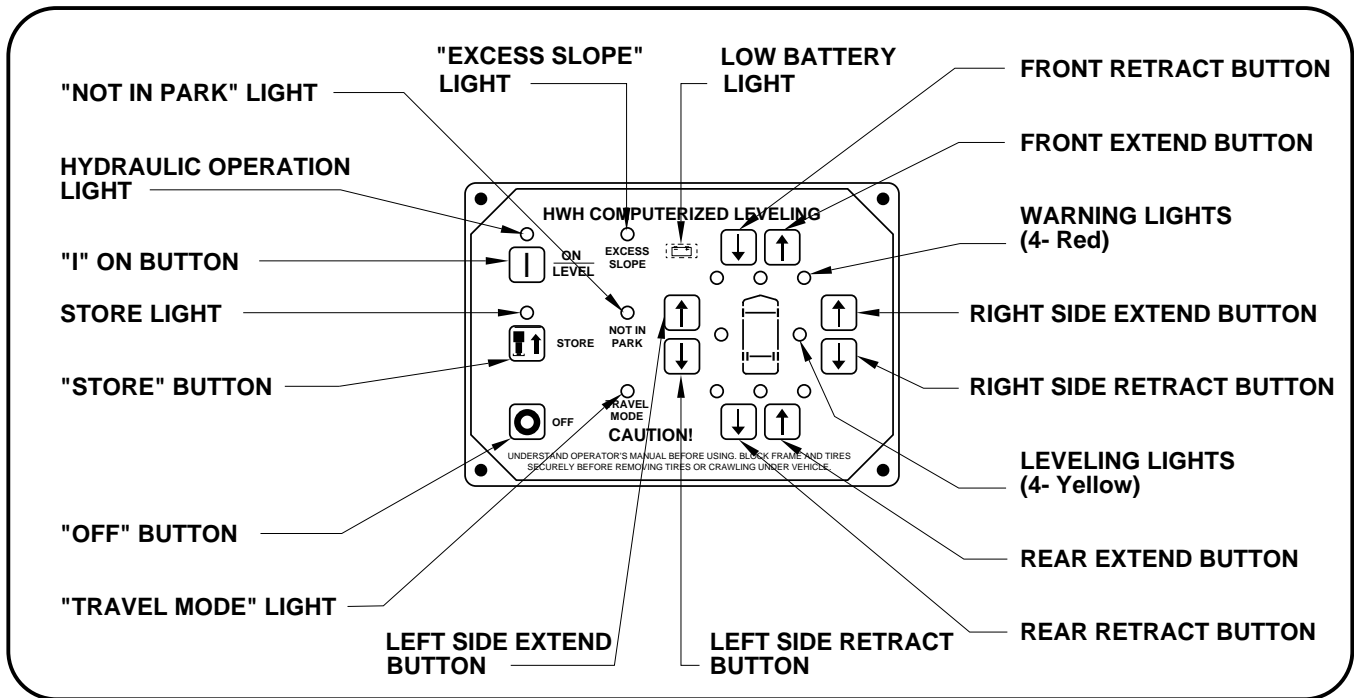

CONTROL FUNCTIONS

CONTROLS

"OFF" BUTTON: Push the "OFF" button to stop hydraulic operation.

"I" BUTTON: This is the on button and automatic operation button. The on indicator light is above the "I" button.

"STORE" BUTTON: The store indicator light is above the "STORE" button. This button is used to automatically retract the jacks.

UP AND DOWN ARROWS: These buttons are for manually controlling jacks. They will operate the jacks in pairs, right side, left side, front and rear. Pushing UP arrows will cause the jacks to extend and raise the vehicle. DOWN arrows will cause the jacks to retract.

INDICATOR LIGHTS

LEVELING LIGHTS: The four yellow indicating lights are level sensing indicators. When a yellow light is on, it indicates that its side or end of the vehicle is low. No more than two lights should be on at the same time.

STORE LIGHT: This light will flash when the system is in the STORE mode.

WARNING LIGHTS: The four red lights surround the yellow level indicators are jack WARNING lights. They are functional only when the ignition is in the "ON" or "ACC" position, the system is on, and the jacks are in the vertical position.

"EXCESS SLOPE" LIGHT: This indicator will light when the leveling system cannot level the vehicle.

"NOT IN PARK/BRAKE" LIGHT: This indicator will light when the panel is on and the hand/auto brake is not set.

"TRAVEL MODE" LIGHT: This indicator light will be on when the ignition is on, when the jacks are retracted and there are no red WARNING lights on.

LOW BATTERY LIGHT: This indicator will be on when the controller senses low voltage.

MASTER "JACKS DOWN" WARNING LIGHT: This is a light mounted in the dash separate from the touch panel. It will be on when any one or more jacks are vertical and the ignition is "ON".

OPERATING PROCEDURES

GENERAL INSTRUCTIONS

Maintain adequate clearance in all directions for vehicle, room extensions, awnings, doors, steps, etc. Vehicle may move in any direction due to jacks extending or retracting, settling of the jacks or the vehicle, equipment malfunction, etc..

If parking on soft ground or asphalt paving, a wood block or pad should be placed under each jack.

Press the "OFF" button and turn the ignition switch "OFF" at any time to stop the operation of the system.

Any time a hydraulic leveling process is interrupted, retract the jacks according to the JACK RETRACTION Section and then restart the leveling process.

If the hand / auto brake is not set when the "HYD" button is pressed, the "NOT IN PARK/BRAKE" light will come on. When the "HYD" button is released the "NOT IN PARK/BRAKE" light will go out. The panel will NOT turn on.

The leveling system should be cycled once a month or whenever the vehicle is used, to keep the system in operating condition.

CAUTION: DO NOT MOVE THE VEHICLE IF ONE OR MORE JACKS ARE EXTENDED TO THE GROUND.

PREPARATION FOR TRAVEL

Before traveling, the red jack warning lights must be off and the "TRAVEL MODE" light must be on. If lights are not correct for travel, retract jack as described in the JACK RETRACTION Section.

If the jacks are retracted but a red "WARNING" light is lit or the green "TRAVEL MODE" light is not lit, the system needs to be serviced.

Any room extension should be fully retracted before traveling.

CAUTION: DO NOT RELY SOLELY UPON WARNING LIGHTS. IT IS THE OPERATOR'S RESPONSIBILITY TO CHECK THAT ALL JACKS ARE FULLY RETRACTED INTO THE STORE/TRAVEL POSITION BEFORE TRAVELING.

Any time the "HYD" button has been pushed, push the "STORE" button before traveling.

If the jacks cannot be retracted according to the JACK RETRACTION Section, retract the jacks according to the MANUAL JACK RETRACTION Section. The system should then be checked.

ROOM EXTENSION PROCEDURES

IMPORTANT: If the vehicle is equipped with a room extension read this section carefully.

If the vehicle is equipped with kick-down jacks, the wheels MUST be blocked securely. It is recommended that the vehicle is leveled and stabilized before any rooms are extended. It is recommended all rooms are retracted before the leveling system is retracted. It is recommended the leveling system is not operated when any room extension is extended.

Refer to the vehicle owners manual for proper operation of room extensions.

IMPORTANT: Do not use a room extension support when the vehicle is supported by the leveling system.

OPERATING PROCEDURES

625 SERIES LEVELING SYSTEM

AUTOMATIC HYDRAULIC LEVELING

1. Place transmission in the recommended position for parking vehicle and set parking brake. Turn the coach engine off. Turn the ignition to the "ACCESSORY" position.
2. Press the "LEVEL" (HYD) button to enter the hydraulic operation mode. The ON light will glow steady.
3. Press the "LEVEL" button a second time. The ON indicator light will start to flash. One at a time the jacks will swing to the vertical position. The red WARNING light for each jack will come on as it's respective jack becomes vertical. At this time, the operator may want to check the jacks and place a pad under each jack if the ground will not support the vehicle.
4. Press the "LEVEL" button a third time. The ON light will start to flash.

The system will automatically extend the jacks to level the vehicle and then extend any remaining jacks for stabilizing. After the system has finished leveling and stabilizing, it will automatically shut off.

EXCESS SLOPE SITUATION: In the event the jacks are unable to level the coach, the "EXCESS SLOPE" light will come on. Excess slope is two jacks fully extending without turning the yellow level light out. The system will not stabilize the vehicle if the "EXCESS SLOPE" light comes on. One or more jacks may not be extended. The system will shut off leaving the "EXCESS SLOPE" light on. The "EXCESS SLOPE" light will remain on if the ignition is in the "ON" or "ACC" position, until the jacks have been fully retracted turning the red warning lights out. Push the "STORE" button to retract the jacks. Move the vehicle to a more level position or level the vehicle as close as possible according to the MANUAL HYDRAULIC OPERATION section.

5. Turn the ignition switch to the "OFF" position.

JACK RETRACTION

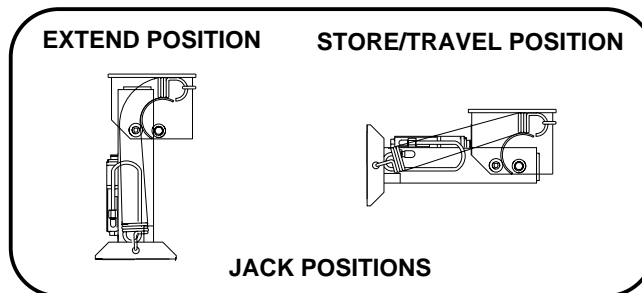

CAUTION: THE OPERATOR MUST BE SURE THAT THERE ARE NO OBJECTS UNDER THE VEHICLE AND THAT ALL PEOPLE ARE CLEAR OF THE VEHICLE.

1. Start the engine. Store the jacks immediately.
2. Press the "STORE" button. The store indicator light will flash. As each jack retracts, its red WARNING light will go out. The system will automatically shut down six minutes after the four individual red "WARNING" lights are out. If any one red "WARNING" light does not go out, the system will continue to store for thirty minutes, then shut down regardless of the "WARNING" lights condition.

NOTE: When traveling thermal expansion may cause a jack to extend slightly. When the "STORE" button has been used to retract the jacks, the system will automatically retract any jack that extends due to thermal expansion.

IMPORTANT: DO NOT interrupt power to the leveling system while the "STORE" indicator light is blinking. DO NOT push the "OFF" button or turn the ignition key. The system must be allowed to completely finish the STORE mode.

CAUTION: DO NOT RELY SOLELY UPON WARNING LIGHTS. IT IS THE OPERATOR'S RESPONSIBILITY TO CHECK THAT ALL JACKS ARE FULLY RETRACTED INTO THE STORE/TRAVEL POSITION BEFORE TRAVELING.

3. The vehicle can be moved as soon as the red warning lights are out, the jacks are in the STORE/TRAVEL position and the green "TRAVEL" light is on.

IMPORTANT: If a red warning light and buzzer come on while traveling, the jacks should be checked as soon as a safe parking location is found.

4. If jacks cannot be retracted by the above procedure see MANUAL JACK RETRACTION Section.

OPERATING PROCEDURES

MANUAL HYDRAULIC OPERATION

1. Place transmission in the recommended position for parking the vehicle, and set the parking brake. Turn the ignition to the "ACCESSORY" position.

2. Press the "LEVEL" (HYD) button.
The indicator light will glow steady.

3. Press the "LEVEL" button a second time. The ON indicator light will start to flash. One at a time, the jacks will swing to the vertical position. The four red WARNING lights will be on. Place a pad under each jack foot if the ground will not support the vehicle on the jacks.

4. The vehicle may be leveled using the manual EXTEND buttons on the right half of the panel. If a yellow LEVEL SENSING light is on, that side, end or corner of the vehicle is low. **Put out any side yellow light before leveling the vehicle from front to rear.**

Jacks will extend (or retract) in pairs to raise (or lower) a side or end of the vehicle. Any jack not used for leveling can be extended to the ground. This provides additional stability against wind and activity in the vehicle.

IMPORTANT: Do not continue to push an EXTEND button for more than ten (10) seconds after that pair of jacks are fully extended.

5. When leveling is completed, push the "OFF" button on the touch panel and turn the ignition switch to the "OFF" position.

MANUAL JACK RETRACTION

NOTE: Use the valve release nuts for retracting only if the "STORE" button on the control panel will not retract the jacks for travel.

CAUTION: KEEP AWAY FROM THE WHEELS, DO NOT CRAWL UNDER THE VEHICLE, KEEP A SAFE DISTANCE IN FRONT AND REAR OF VEHICLE. THE VEHICLE MAY DROP AND/OR MOVE FORWARD OR BACKWARD WITHOUT WARNING AS THE VALVE RELEASE IS OPERATED.

1. Locate the 4 valve release nuts on the solenoid valves
The solenoid valves are located on the pump/valve assembly
See the "HYDRAULIC LINE CONNECTION DIAGRAM LEVELING SYSTEM."

2. Allow clearance for vehicle to lower.

3. Use the 1/4" nut driver in the end of the breather cap.
clean around the cap before removing. Cover the hole after removing the cap.

4. Retract the rear jacks by opening the two outer valves. Slowly turn the release nuts counter clockwise. The nuts may turn easily at first but as an internal spring is compressed, turning may become more difficult. The valves need only to be opened enough to retract the jack. DO NOT turn the nuts more than 4 1/2 turns.

5. Retract the front jacks by opening the two center valves as described in Step 3.

6. Check that all four jacks are now retracted.

7. Close the valves by turning the nuts clockwise.

Once the internal spring tension has been released, the release nuts will turn free for several turns. Once the release nuts are snug, DO NOT tighten the nuts past this point as internal damage may occur to the solenoid.

8. Replace the breather cap.

9. The system should now be repaired before using again.

10. Push the "STORE" button before traveling.

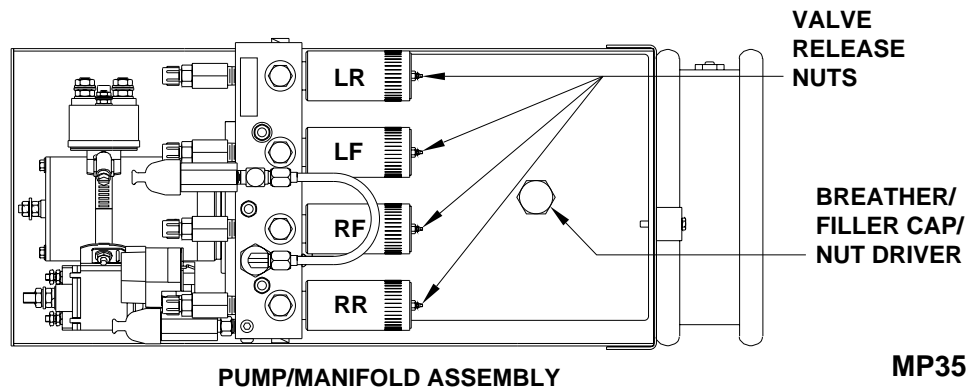

MP35.602G
10SEP03

MAINTENANCE

OIL LEVEL

All maintenance should be done as part of the normal servicing of the coach.

The oil level should be checked when the vehicle is first purchased and then once every two years. More often if there is an oil leak in the system.

All four jacks should be completely retracted before checking the oil level. The oil reservoir is part of the pump/manifold assembly. The oil level is checked and filled through the breather cap. Clear any dirt away from the breather/filler cap before removing. The oil level should be within one inch of the top of the reservoir. Most breather caps have a dipstick.

NOTE: Overfilling the tank can cause leakage of oil through the breather cap.

FLUID: HWH Specialty Hydraulic Oil is recommended. In an emergency Dexron automatic transmission fluid can be used. **NOTE:** Dexron automatic transmission fluid contains red dye and can cause staining should a leak occur. **DO NOT USE** brake fluid or hydraulic jack fluid. Use of these can damage seals.

ELECTRICAL SYSTEM

The batteries should be in good condition and fully charged. Weak batteries can cause erratic operation. Battery cable terminals and battery posts and connections should be kept clean.

All electrical connections, especially ground connections, should be clean, tight, free from corrosion and protected from weathering.

LEVELING JACKS

There are very few user serviceable parts on the leveling jacks. The jacks require very little maintenance. If the jacks are extremely dirty with caked on mud they should be washed.

The jack rods should NOT be wiped and do not need to be oiled or sprayed with anything. See maintenance, SYSTEM ADJUSTMENT.

VISUAL INSPECTION

Periodically inspect the leveling system for oil leaks and damaged or missing parts, such as pivot bolts or springs. Check the hydraulic lines and wiring for damage and wear. Check that the jacks do not interfere with any parts of the vehicle when they are in the "STORE" position.

The jacks should be cycled at least once a month or whenever the coach is serviced. The system will operate better if kept clean and free from caked on mud or ice.

OPERATIONAL CHECK

Review the OPERATOR MANUAL. Run the system according to the SYSTEM OPERATION (LEVELING) Section. Note any abnormal operation.

Check that all lights work according to the "INDICATOR LIGHT" Section. Correct function of the red "WARNING" light is important.

Review the "JACK RETRACTION" Section. Make sure the jacks will fully retract to the "STORE" position. Jacks should not interfere with any of the coach when in the "STORE" position.

MAINTENANCE

NOT IN PARK/BRAKE CHECK

CAUTION: WHEN MAKING THIS CHECK, BLOCK THE COACH WHEELS SECURELY SO THE COACH CANNOT ROLL FORWARD OR BACKWARD.

Set the park/brake. Switch the ignition to the "ACC" or "ON" position. Push the "ON/OFF" switch toward "ON". Release the parking brake and confirm that the "PARK" indicator light comes on. Reset the parking brake. The "PARK" indicator light should go out. Switch the ignition to "OFF".

If any of the above checks or inspections reveal a problem or if there are other problems or questions, consult a qualified RV repair center, your vehicle or coach manufacturer, or HWH CORPORATION for service or repair.

SYSTEM ADJUSTMENT

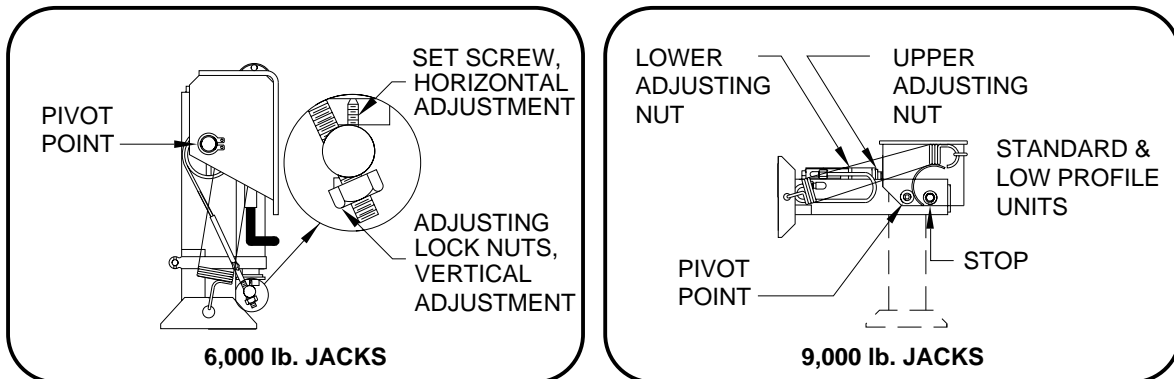

JACK ADJUSTMENT

There are two basic adjustments which are made at the time of installation. However, when adjustment of a leveling unit is needed, the following procedures are recommended.

1. 6,000 lb. JACKS: Always make vertical adjustment first. If the vertical adjustment is changed at anytime, be sure to check the horizontal adjustment. Vertical position is changed by adjusting the lock nuts on the actuator cable. If the jack stopped short of vertical, tighten the lock nuts. If the jack goes past vertical, back the lock nuts off. Be sure to adjust each nut the same number of turns.

NOTE: The two front jacks should be adjusted to the same horizontal position.

Horizontal stop is adjusted by turning the set screws located just inside the cable locknuts. The jack can be adjusted down to provide clearance for objects which may interfere with the operation of the jacks. The horizontal stop must be adjusted to provide clearance between the hat bracket and mounting bolts; and the actuator and hose fittings, when the jack is in the STORE POSITION. The jack must be able to fully extend in the horizontal position without interfering with suspension components, tanks, etc.

The only maintenance is to keep the jacks clean by washing and oiling the pivot points several times a year when doing general maintenance on the vehicle.

2. 9,000 lb. JACKS: Each jack should be checked to be sure that it is vertical when it swings down. To do this, retract all jacks, then extend each jack until it is close to, but not touching the ground. If the jack stopped short of being vertical, it can be adjusted by loosening the lower adjusting nut and tightening the upper nut.

The horizontal stop can be adjusted up or down in the slot to provide clearance for objects which may interfere with operation of the jack. The stop must be adjusted so that the jack can be fully extended in the horizontal position without interfering with suspension components, tanks, etc.

The 9000# jack has a roller bearing on the opposite side from the stop. It needs to roll freely. Oiling the roller bearing whenever general vehicle maintenance is done is a good idea. Also oil the pivot point at the same time. The only other maintenance to the jack is to keep it clean by washing.

MAINTENANCE/SERVICE

SENSING UNIT ADJUSTMENT

Level the vehicle by placing a bubble level in the center of the freezer floor or upon whichever surface within the vehicle that is to be level. Using the Leveling System and the bubble level, ignoring the yellow LEVEL lights on the Touch Panel, level the vehicle until the bubble is centered.

With the vehicle level according to the bubble level, if there are no yellow lights lit on the Touch Panel, the sensing unit is properly adjusted. If there are yellow LEVEL lights lit on the Touch Panel, manual adjustments to the Sensing Unit are needed. A 7/8", 3/4" or 5/16" socket w/driver or box end wrench and a philips screw driver will be needed.

The Sensing Unit is mounted inside the Control Box. The Control Box is mounted to the power unit/valve assembly.

There are four LED's on the Sensing Unit, A,B,C and D. Refer to the drawing below. The Sensing Unit is adjusted by turning the adjustment nut to turn out LED's B and D. The adjustment screw will turn out LED's A and C. If the adjustment nut has to be turned more than 1/2 flat or the adjustment screw has to be turned more than 3/4 turn to turn the LED out, there may be a problem with the Sensing Unit or the mounting of the Control Box. If two LED's are on, it is best to make the B-D adjustments first, then hold the adjustment nut from moving while making the A-C adjustment.

NOTE: If opposing LED's are lit, there is a problem with the Sensing Unit.

If LED (A) is lit: Turn the adjustment screw COUNTER CLOCKWISE until the LED is off.

If LED (C) is lit: Turn the adjustment screw CLOCKWISE until the LED is off.

If LED (B) is lit: Turn the adjustment nut COUNTER CLOCKWISE until the LED is off.

If LED (D) is lit: Turn the adjustment nut CLOCKWISE until the LED is off.

When all 4 LED's are off, move the vehicle to an unlevel vehicle position so one or two yellow lights are on. Level the vehicle according to the yellow LEVEL lights. Recheck the level. Readjust as necessary. Repeat this until the vehicle can be leveled using the yellow LEVEL lights.

TOP VIEW - SENSING UNIT

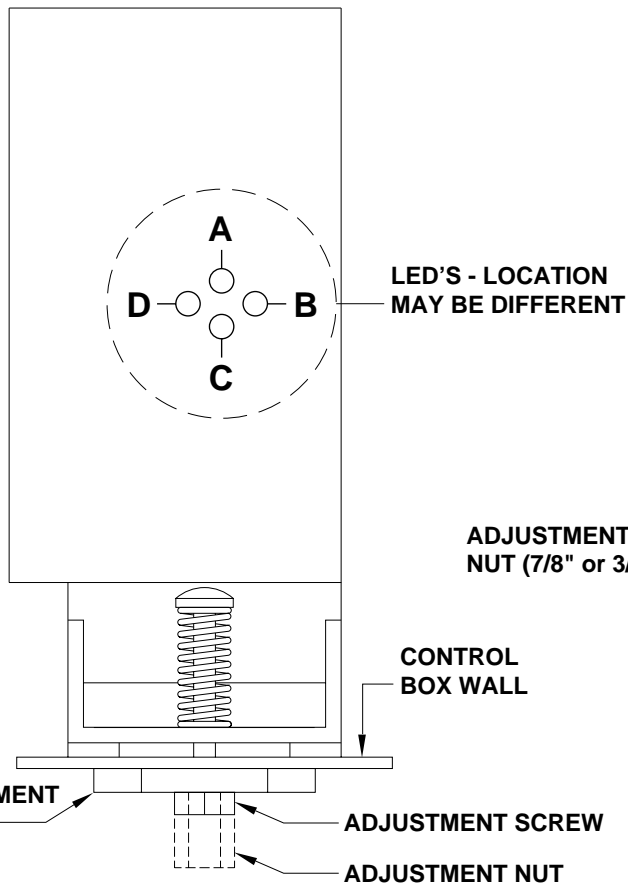

SIDE VIEW - CONTROL BOX

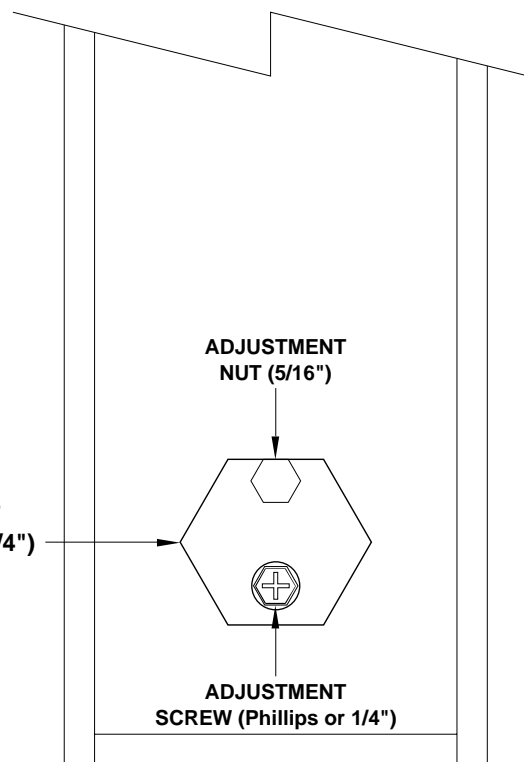

HYDRAULIC LINE CONNECTION DIAGRAM

625 SERIES LEVELING SYSTEM

(WITH 4 KICK-DOWN JACKS)

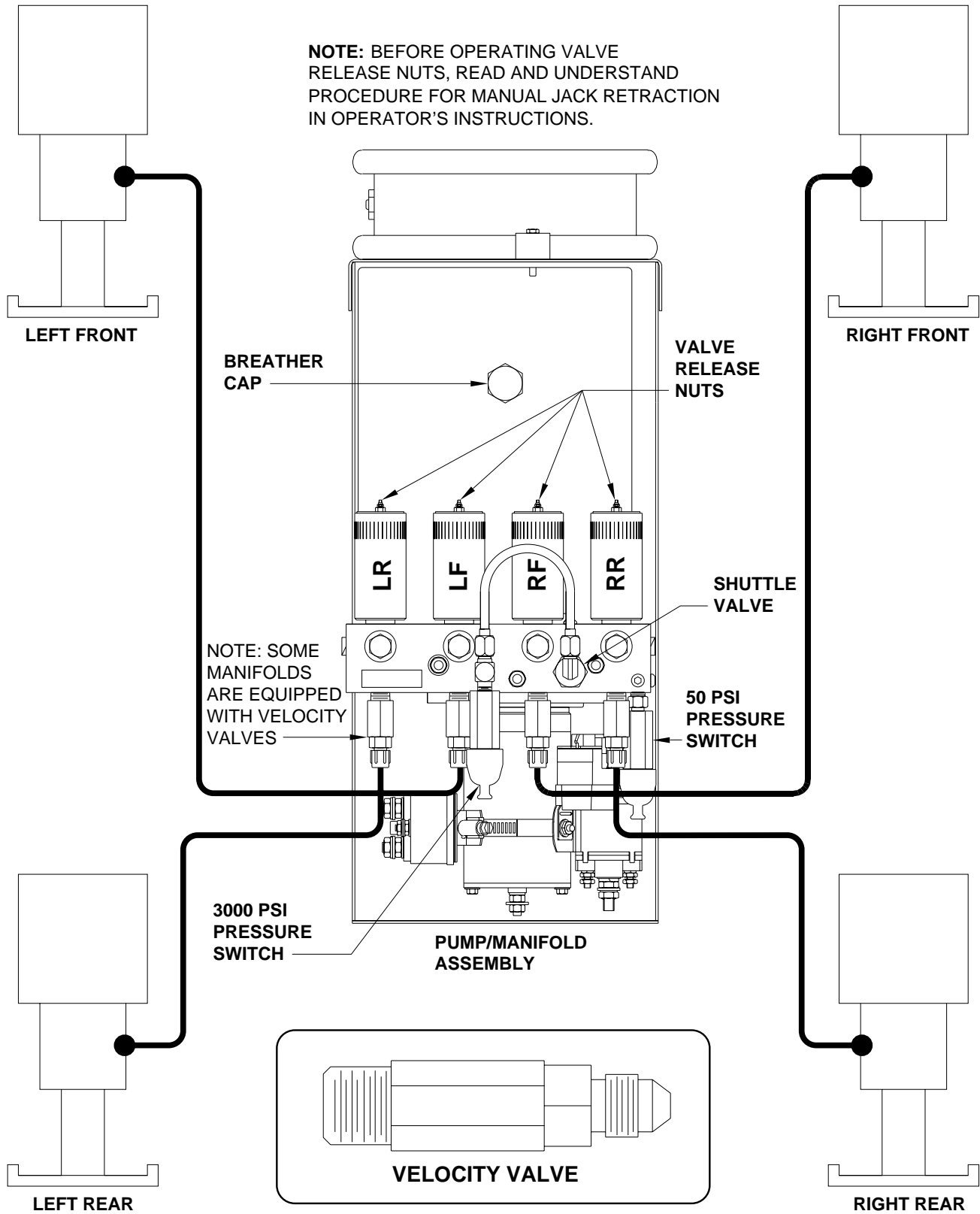

HYDRAULIC SCHEMATIC

625 SERIES BI-AXIS LEVELING WITH KICK-DOWN JACKS

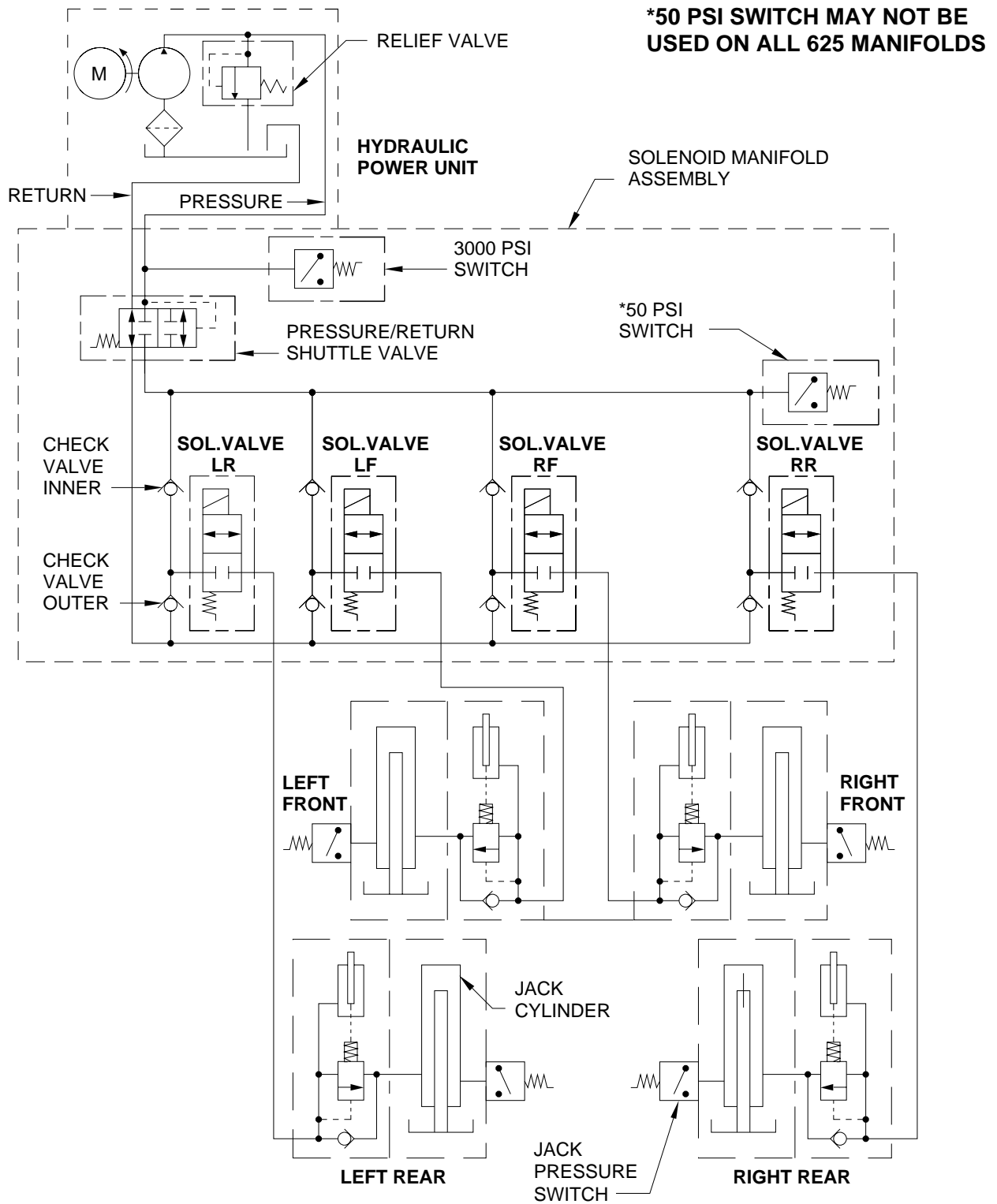

ELECTRICAL CONNECTION DIAGRAM

625 SERIES LEVELING SYSTEM

PARK BRAKE - MASTER WARNING LIGHT AND BUZZER

TOUCH PANEL - JACK WARNING LIGHTS AND PRESSURE SWITCHES

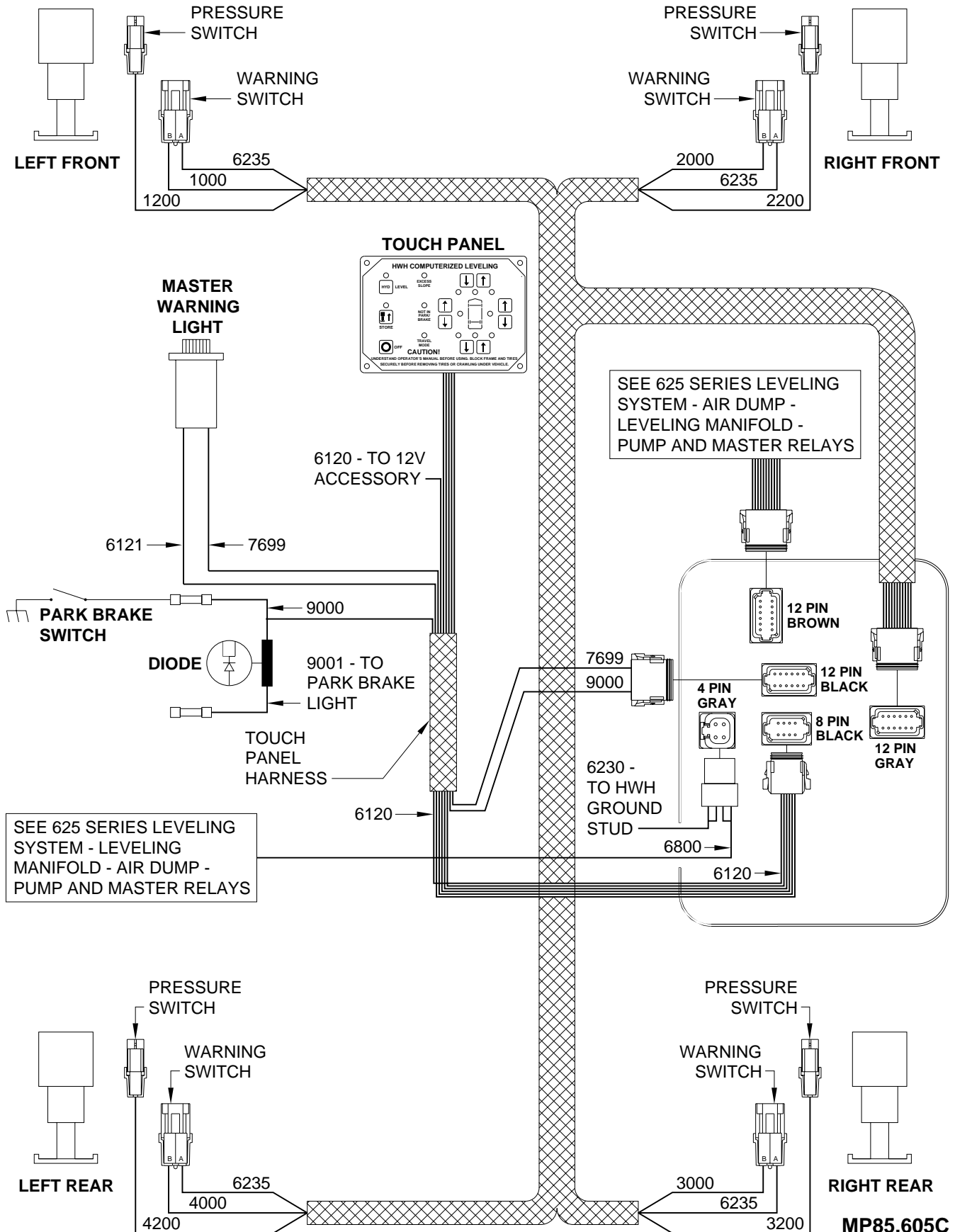

ELECTRICAL CONNECTION DIAGRAM 625 SERIES LEVELING SYSTEM LEVELING MANIFOLD 12 VOLT PUMP AND MASTER RELAYS

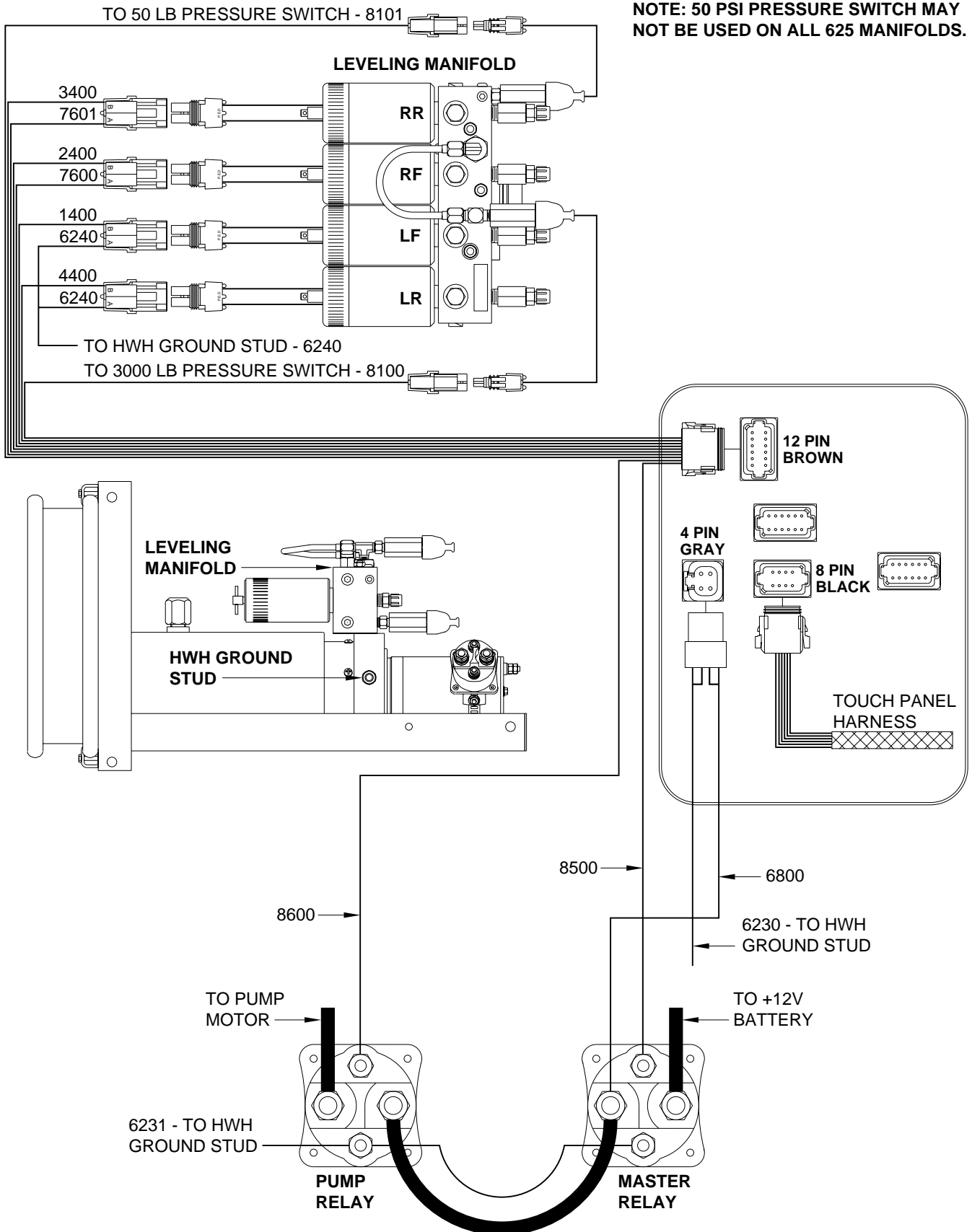

ELECTRICAL CONNECTION DIAGRAM

625 SERIES LEVELING SYSTEM

CONTROL BOX CONNECTION INFORMATION

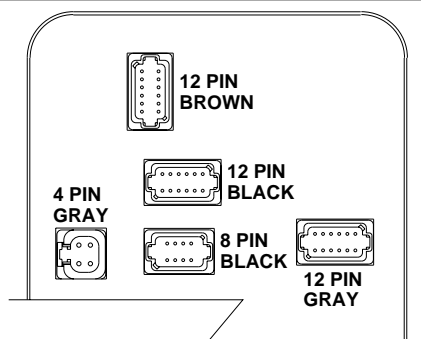

PIN #	WIRE COLOR	WIRE NUMBER	WIRE DESCRIPTION AND FUNCTION
GRAY CONNECTOR			4 PIN GRAY CONNECTOR
1	RED	6800	SWITCHED +12V BATTERY POWER FROM MASTER RELAY
2	RED	6800	SWITCHED +12V BATTERY POWER FROM MASTER RELAY
3	WHITE	6230	GROUND FROM HWH GROUND STUD
4	WHITE	6230	GROUND FROM HWH GROUND STUD
BROWN CONNECTOR			12 PIN BROWN CONNECTOR
1	BLACK	8500	MASTER RELAY CONTROL - SWITCHED +12
2	BLACK	8100	3000 LB PRESSURE SWITCH - SWITCHED GROUND
3	BLACK	8101	50 LB PRESSURE SWITCH - SWITCHED GROUND (MAY NOT BE USED)
4			NO CONNECTION
5	BLACK	1400	SWITCHED +12 FOR LEFT FRONT SOLENOID VALVE
6	BLACK	7600	GROUND FOR RIGHT FRONT SOLENOID VALVE
7	BLACK	7601	GROUND FOR RIGHT REAR SOLENOID VALVE
8	BLACK	4400	SWITCHED +12 FOR LEFT REAR SOLENOID VALVE
9	BLACK	3400	SWITCHED +12 FOR RIGHT REAR SOLENOID VALVE
10	BLACK	2400	SWITCHED +12 FOR RIGHT FRONT SOLENOID VALVE
11			NO CONNECTION
12	BLACK	8600	PUMP RELAY CONTROL - SWITCHED +12
BLACK CONNECTOR			12 PIN BLACK CONNECTOR
1 THRU 6			NO CONNECTION
7	BLACK	9000	SWITCHED GROUND FROM PARK BRAKE SWITCH
8 THRU 10			NO CONNECTION
11	BLACK	7699	MASTER WARNING - SWITCHED GROUND
12			NO CONNECTION
BLACK CONNECTOR			8 PIN BLACK CONNECTOR
1 AND 2			NO CONNECTION
3	RED	6800	SWITCHED ACC OR IGNITION TO TOUCH PANEL
4	WHITE	6230	GROUND
5			CAN SHIELD
6	RED	6120	SWITCHED ACC. TO CONTROL BOX
7	GREEN		CAN LOW
8	YELLOW		CAN HIGH
GRAY CONNECTOR			12 PIN GRAY CONNECTOR
1 AND 2			NO CONNECTION
3	BLACK	1000	SWITCHED GROUND FROM LEFT FRONT WARNING SWITCH
4	BLACK	2000	SWITCHED GROUND FROM RIGHT FRONT WARNING SWITCH
5	BLACK	1200	SWITCHED GROUND FROM LEFT FRONT PRESSURE SWITCH
6	BLACK	2200	SWITCHED GROUND FROM RIGHT FRONT PRESSURE SWITCH
7	BLACK	3200	SWITCHED GROUND FROM RIGHT REAR PRESSURE SWITCH
8	BLACK	4200	SWITCHED GROUND FROM LEFT REAR PRESSURE SWITCH
9	BLACK	3000	SWITCHED GROUND FROM RIGHT REAR WARNING SWITCH
10	BLACK	4000	SWITCHED GROUND FROM LEFT REAR WARNING SWITCH
11			NO CONNECTION
12	WHITE	6235	SHARED GROUND FOR WARNING SWITCHES

ELECTRICAL CONNECTION DIAGRAM

625 SERIES LEVELING SYSTEM

CONTROL BOX - LED - FUSE LOCATION AND DESCRIPTION

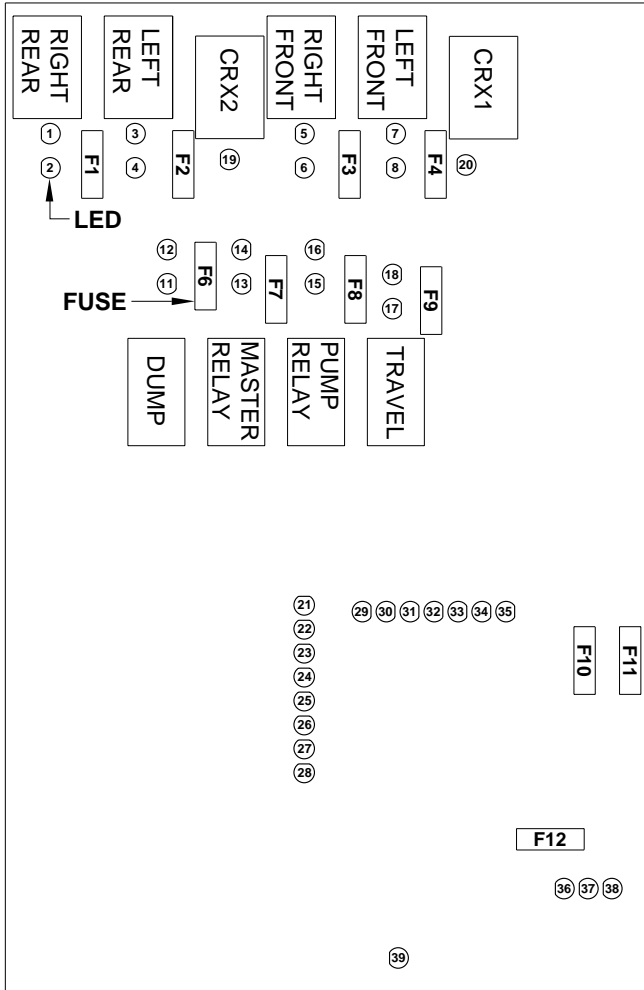

LED	RELAY DESCRIPTION	FUSE
1-YELLOW	RIGHT REAR COIL	F1 - 15 AMP
2-RED	RIGHT REAR OUTPUT	
3-YELLOW	LEFT REAR COIL	F2 - 15 AMP
4-RED	LEFT REAR OUTPUT	
5-YELLOW	RIGHT FRONT COIL	F3 - 15 AMP
6-RED	RIGHT FRONT OUTPUT	
7-YELLOW	LEFT FRONT COIL	F4 - 15 AMP
8-RED	LEFT FRONT OUTPUT	
11-YELLOW	DUMP COIL - NOT USED	F6 - 5 AMP
12-RED	DUMP OUTPUT - NOT USED	
13-YELLOW	MASTER RELAY COIL	F7 - 5 AMP
14-RED	MASTER RELAY OUTPUT	
15-YELLOW	PUMP COIL	F8 - 5 AMP
16-RED	PUMP OUTPUT	
17-YELLOW	TRAVEL - NOT USED	F9 - 5 AMP
18-RED	TRAVEL - NOT USED	
19-YELLOW	CRX 2	F10 - 10 AMP
20-YELLOW	CRX 1	
21-YELLOW	LEFT FRONT WARN SW	F11 - 3 AMP
22-YELLOW	RIGHT FRONT WARN SW	
23-YELLOW	RIGHT REAR WARN SW	F12 - 7.5 AMP
24-YELLOW	LEFT REAR WARN SW	
25-RED	LEFT FRONT PRESS SW	F10 - 10 AMP
26-RED	RIGHT FRONT PRESS SW	
27-RED	RIGHT REAR PRESS SW	F11 - 3 AMP
28-RED	LEFT REAR PRESS SW	
29-RED	NOT USED	F12 - 7.5 AMP
30-YELLOW	NOT USED	
31-GREEN	3000 LB PRESS SW INPUT	F10 - 10 AMP
32-RED	MASTER WARN CONTROL	
33-GREEN	50 LB PRESS SW INPUT	F11 - 3 AMP
34-RED	JACK INTERRUPT	
35-RED	PARK BRAKE	F12 - 7.5 AMP
36-RED	BOARD ENABLE	
37-RED	ACCESSORY IN	F10 - 10 AMP
38-RED	ACCESSORY OUT	
39-RED	LINK LIGHT	F11 - 3 AMP
	IGN +12 TO TOUCH PANEL	

NOTE: FOR DETAILED INPUT / OUTPUT INFORMATION ABOUT PIN CONNECTIONS SEE ELECTRICAL CONNECTION DIAGRAM - CONTROL BOX CONNECTION INFORMATION.

NOTE: A LIT YELLOW LED INDICATES THERE IS A GROUND SIGNAL TO TURN THE CORRESPONDING RELAY ON.

A LIT RED LED INDICATES THERE IS VOLTAGE ON IT'S CORRESPONDING OUTPUT PIN.

IF A YELLOW LED IS LIT AND THE CORRESPONDING RED LED IS OFF, EITHER IT'S FUSE IS BLOWN OR THE RELAY IS BAD.

IF THE YELLOW LED'S ARE WORKING BUT NO RED LED IS COMING ON THERE MAY BE PROBLEM WITH INPUT VOLTAGE IN THE 4-PIN CONNECTOR.

IF A YELLOW LED IS NOT LIT, THERE IS A PROBLEM WITH THE CONTROL BOX, TOUCH PANEL OR CONNECTION CABLE

NOTE: THE TRAVEL RELAY IS WIRED AS A NORMALLY CLOSED RELAY. WHEN THE YELLOW LED (17) IS ON THE RELAY CONTACTS WILL OPEN. THE RED LED (18) WILL NOT BE ON. THE RED LED WILL BE ON IF THE LEVELING SYSTEM IS IN THE TRAVEL MODE AND THE IGNITION IS ON.

BREATHER CAP - DIPSTICK - 1/4" NUT DRIVER

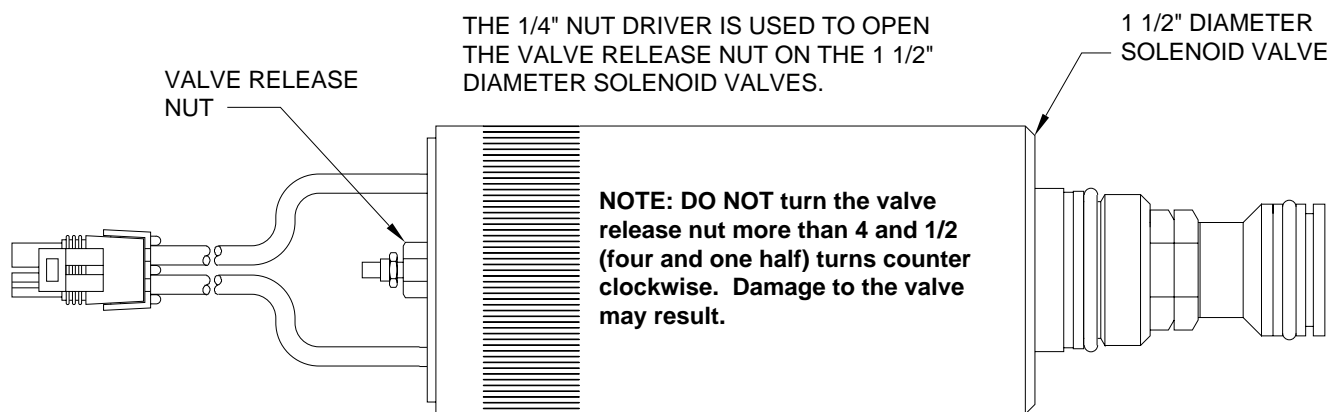

NOTE: THE BREATHER CAP IS LOCATED ON THE TOP SIDE OF THE POWER UNIT RESERVOIR.

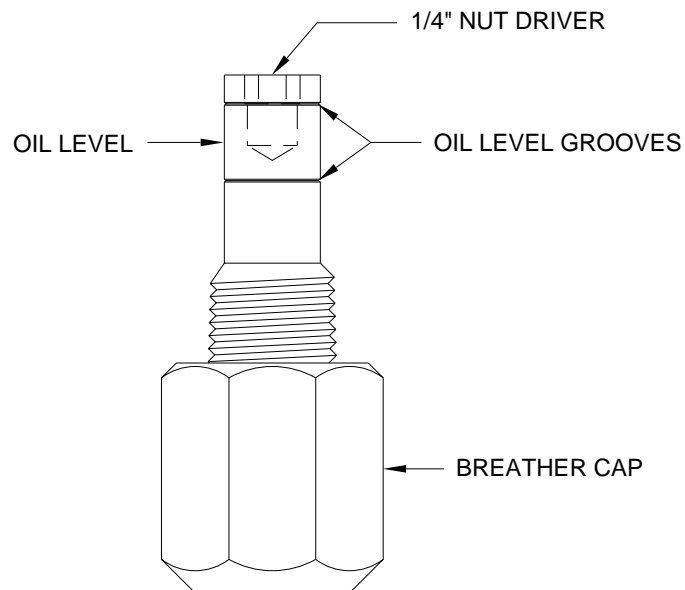

IMPORTANT: PRIOR TO REMOVING THE BREATHER CAP, EITHER TO CHECK THE OIL LEVEL OR TO USE THE 1/4" NUT DRIVER, CLEAN ANY DEBRIS FROM THE TOP OF THE RESERVOIR. BEFORE RETURNING THE BREATHER CAP TO THE RESERVOIR, REMOVE ANY PAINT CHIPS OR OTHER DEBRIS FROM THE DIPSTICK INCLUDING DEBRIS INSIDE THE 1/4" NUT DRIVER.

HWH COMPUTER-CONTROLLED HYDRAULIC LEVELING SYSTEM WITH KICK-DOWN JACKS

CAUTION: READ AND UNDERSTAND ENTIRE OPERATOR'S MANUAL INCLUDING CAUTIONS, BEFORE OPERATING. THIS SHEET IS FOR QUICK REFERENCE ONLY.

AUTOMATIC LEVELING

1. TURN IGNITION SWITCH TO THE "ACCESSORY" POSITION. TRANSMISSION SHIFT MUST BE IN POSITION FOR PARKING. PARK BRAKE MUST BE SET EITHER MANUALLY OR AUTOMATICALLY. IF "NOT IN PARK/BRAKE" LIGHT IS ON, CHECK SHIFT AND BRAKE POSITION.
2. PRESS "I" (ON/AUTO). THE HYDRAULIC OPERATION INDICATOR LIGHT WILL COME ON STEADY.
3. PRESS "I" (ON/AUTO) 2nd TIME. THE INDICATOR LIGHT WILL FLASH. JACKS WILL SWING VERTICAL.
4. WHEN LIGHT IS ON STEADY AGAIN, PRESS "I" (ON/AUTO) 3rd TIME. THE INDICATOR LIGHT WILL FLASH. COACH WILL LEVEL THEN THE SYSTEM WILL TURN OFF.

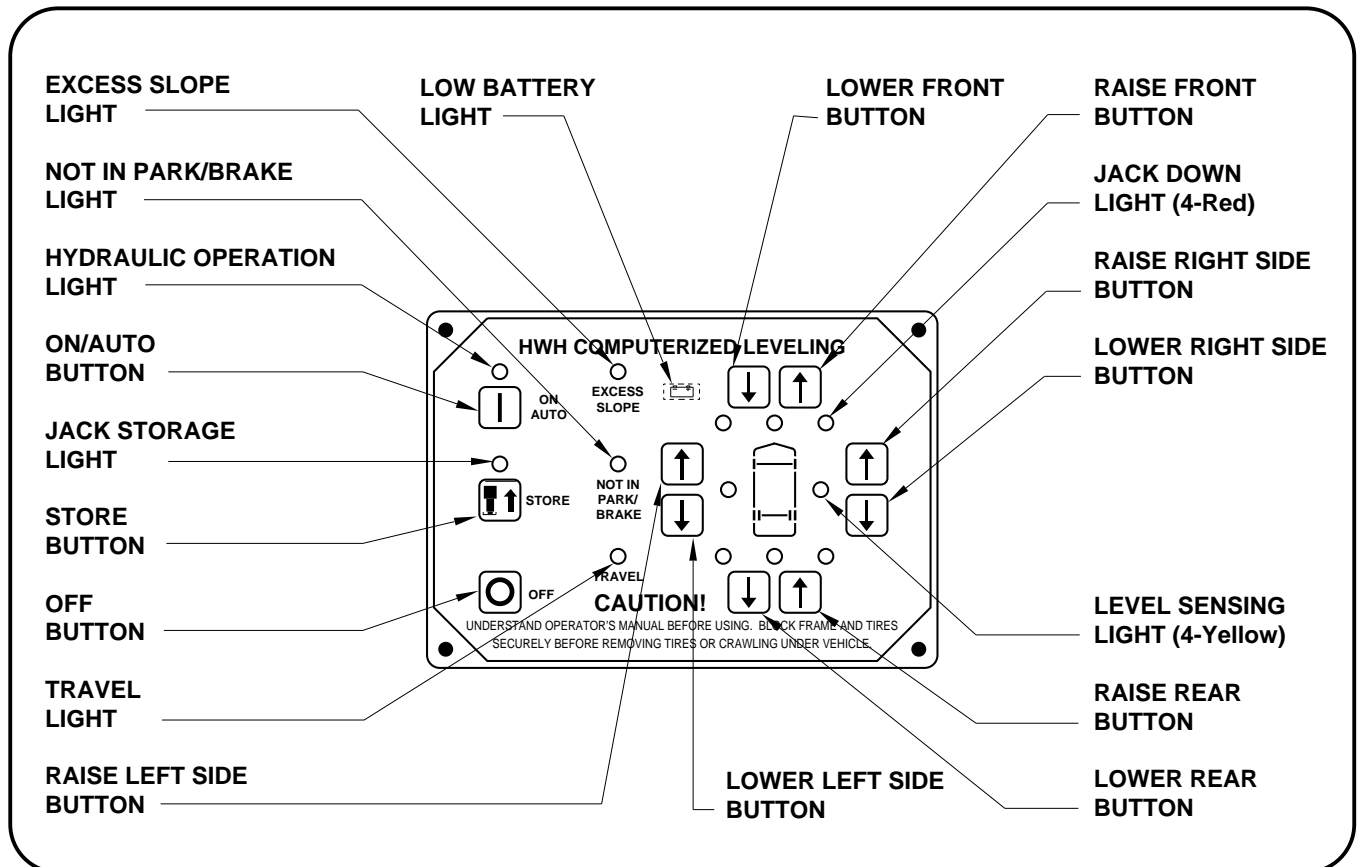

HWH COMPUTER-CONTROLLED HYDRAULIC LEVELING SYSTEM WITH KICK-DOWN JACKS (CONTINUED)

STORE OPERATION

1. START THE ENGINE. STORE THE JACKS IMMEDIATELY.
2. PRESS "STORE". STORE INDICATOR LIGHT WILL FLASH. JACKS WILL RETRACT.
3. WHEN "TRAVEL" LIGHT IS ON, THE COACH MAY BE MOVED. SYSTEM WILL SHUT ITSELF OFF.

IMPORTANT: DO NOT INTERRUPT POWER TO THE SYSTEM UNTIL THE SYSTEM AUTOMATICALLY SHUTS ITSELF OFF.

MANUAL OPERATION

1. TURN IGNITION SWITCH TO THE "ACCESSORY" POSITION. TRANSMISSION SHIFT MUST BE IN POSITION FOR PARKING. PARK BRAKE MUST BE SET EITHER MANUALLY OR AUTOMATICALLY. IF "NOT IN PARK/BRAKE" LIGHT IS ON CHECK SHIFT AND BRAKE POSITION.
2. PRESS "I" (ON/AUTO). INDICATOR LIGHT WILL COME ON STEADY.
3. PRESS "I" (ON/AUTO) 2nd TIME. LIGHT WILL FLASH. JACKS WILL SWING VERTICAL.

ON THE RIGHT HAND PORTION OF THE TOUCH PANEL NOTE THE OUTLINE OF A COACH AND THE VARIOUS RAISE (UP ARROW) AND THE LOWER (DOWN ARROW) TOUCH BUTTONS.

4. PRESS THE RESPECTIVE RAISE (UP ARROW) BUTTON TO RAISE THE RESPECTIVE SIDE OR END OF THE COACH. A YELLOW LIGHT TO THE FRONT, SIDE OR REAR OF THE COACH OUTLINE INDICATES THAT SIDE OR END IS LOW. THE LOWER (DOWN ARROW) BUTTONS WILL LOWER THE COACH.

NOTE: JACKS WILL ALWAYS WORK IN PAIRS, FRONT, RIGHT SIDE, LEFT SIDE, OR REAR.